

COMP. 3 cm 115

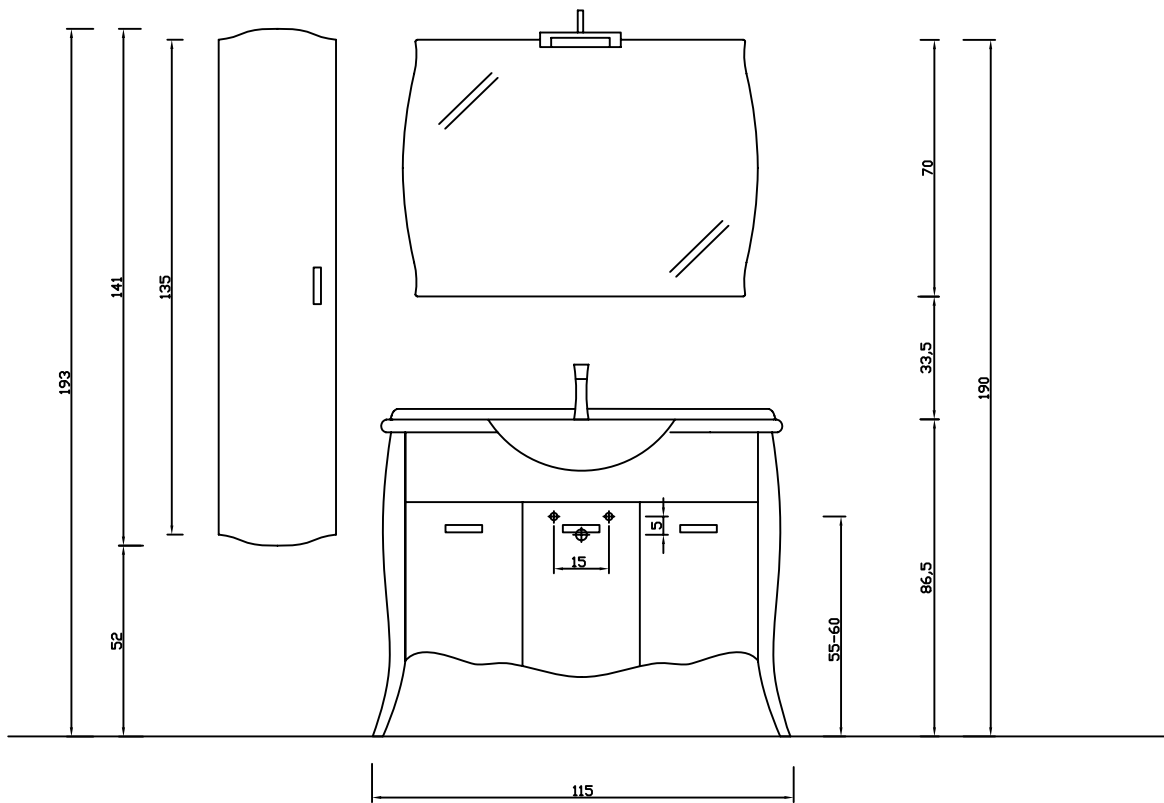
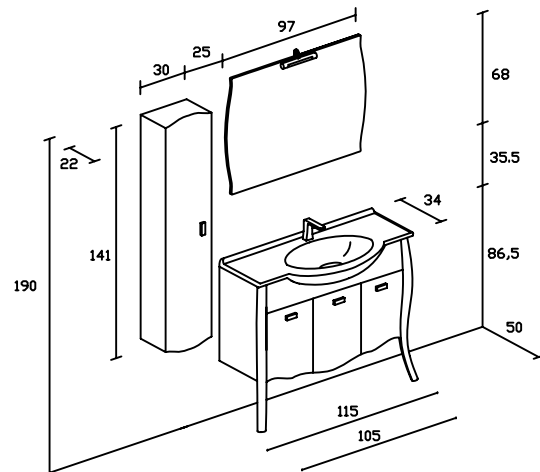

LE MISURE CONSIGLIATE DI CARICO E SCARICO DELL'ACQUA SONO INDICATE NEI DISEGNI SOVRASTANTI.

THE SUGGESTED MEASURES OF WATER CHARGE AND DISCHARGE ARE INDICATED IN THE ABOVE DRAWINGS.

LES MESURES CONSEILLÉES DE CHARGEMENT ET DÉCHARGEMENT DELL'EAU SONT INDIQUÉS DANS LES DESSINS SITUÉ AU-DESSUS

Рекомендуемые размеры для подвода воды приведены в рисунках выше