

MERCHANDISING

2025

MERCHANDISING

2025

A photograph of a modern building featuring a prominent glass dome structure. The building has a curved facade with large windows and a central entrance. A large, leafy tree stands in front of the entrance. The foreground shows a paved walkway leading towards the building, flanked by green grass and a bush of white roses. The sky is overcast.

DESIRE TO INSPIRE

VIVI L'ESPERIENZA NEWFORM

Entra e lasciati avvolgere dal mondo Newform. Respira e lasciati rapire dalla piacevole sensazione di essere accolto in uno spazio elegante e raffinato, un ambiente piacevole che unisce diversi stili in modo equilibrato. La varietà di forme e colori sono accomunati da un unico fattore: il design ricercato di Newform, che diventa il brand simbolo di bellezza e armonia.

LIVE THE NEWFORM EXPERIENCE

Enter and get involved in the Newform world. Breathe and let yourself be carried away by the pleasant sensation of being welcomed into an elegant and refined space, a pleasant environment which combines different styles in a balanced way. A single factor combines the variety of shapes and colours: the refined Newform design, which becomes the symbol of beauty and harmony.

VIVEZ L'EXPÉRIENCE NEWFORM

Entrez et laissez-vous envelopper par le monde de Newform. Respirez et laissez-vous séduire par l'agréable sensation d'être accueilli dans un espace élégant et raffiné, un environnement agréable qui combine différents styles de manière équilibrée. La variété des formes et des couleurs est unie par un seul facteur : le design raffiné de Newform, qui devient la marque symbole de la beauté et de l'harmonie.

ERLEBE DAS NEWFORM-ERLEBNIS

Tauche ein und lass dich von der Welt von Newform umgeben. Atme ein und lass dich von dem angenehmen Gefühl gefangen nehmen, in einem eleganten und raffinierten Raum willkommen zu sein - eine angenehme Umgebung, die verschiedene Stile harmonisch vereint. Die Vielfalt an Formen und Farben wird durch einen gemeinsamen Faktor verbunden: das exquisite Design von Newform, das zur Symbol für Schönheit und Harmonie wird.

VIVE LA EXPERIENCIA NEWFORM

Entra y déjate envolver por el mundo Newform. Respira y déjate cautivar por la agradable sensación de ser recibido en un espacio elegante y refinado, un ambiente agradable que combina diferentes estilos de forma equilibrada. La variedad de formas y colores responde a un único factor: el diseño selecto de Newform, que se convierte en la marca símbolo de belleza y armonía.

NEWFORM EXPERIENCE



CIRCONDATI DI ELEGANZA

Il concetto di Benessere di Newform si traduce nell'ambiente bagno nell'equilibrio tra qualità e Design, nel circondarsi di prodotti belli in armonia con l'ambiente in cui vengono inseriti. Newform offre la possibilità di scegliere tra molteplici collezioni con la certezza di potersi regalare un prodotto capace di soddisfare sia esigenze tecniche che stilistiche.

SURROUND YOURSELF WITH ELEGANCE

Newform Wellness concept balances quality and interior design into the bathroom that results in beautiful products blended in harmony with the atmosphere around it. Newform offers the possibility to choose from multiple collections with the certainty of being able to provide a product that can satisfy both technical and stylistic needs.

ENTOURÉS D'ÉLÉGANCE

Le concept Bien-être de Newform se traduit, dans l'espace salle de bain, par l'équilibre entre qualité et design, et par l'harmonie entre les beaux produits et l'espace dans lequel ils sont insérés. Newform offre la possibilité de choisir parmi de nombreuses collections avec la certitude de pouvoir s'offrir un produit capable de satisfaire les exigences.

UMGEBEN VON ELEGANZ

Das Wellness-Konzept von Newform findet im Badezimmer seinen Ausdruck in der Balance zwischen Qualität und Design, umgeben von ästhetisch ansprechenden Produkten, die perfekt in ihre Umgebung passen. Newform bietet die Möglichkeit, aus verschiedenen Kollektionen zu wählen und sich dabei sicher zu sein, ein Produkt zu erwerben, das sowohl technische als auch stilistische Anforderungen erfüllen kann.

RODÉATE DE ELEGANCIA

El concepto de Bienestar de Newform se traduce en el ambiente del baño en el equilibrio entre calidad y diseño, en rodearse de productos bellos y armoniosos con el entorno en el que se insertan. Newform ofrece la posibilidad de elegir entre múltiples colecciones con la certeza de poder regalarse un producto capaz de satisfacer tanto las necesidades técnicas como estilísticas.



NEWFORM ATTITUDE

Progettare e realizzare articoli che rispecchiano fedelmente le tue esigenze, i tuoi gusti, i tuoi desideri: questo è ciò che Newform è in grado di offrire grazie alla sua capacità produttiva 100% Made in Italy.

Un servizio "tailor made" che forgia prodotti in grado di soddisfare le esigenze con il più alto grado di personalizzazione, unendo l'esperienza e l'affidabilità a un design curato e distintivo. Perché questo è il solo modo che conosciamo per stare al passo con le evoluzioni del mercato, rispondendo sempre alle tue richieste con professionalità, metodo, precisione e rapidità.

Ogni prodotto personalizzato è un'opera unica, plasmata su misura per raccontare la storia di chi lo sceglie, trasformando il desiderio in realtà.

Designing and realizing products that accurately reflect your needs, your preferences, your wishes: this is what Newform can offer thanks to its 100% Made in Italy production capability.

A "tailor-made" service aimed at forging products able to satisfy the highest levels of customization by combining the experience and the reliability of Newform in a unique and refined design. This is how Newform stays one step ahead in an ever evolving market, by being able to consistently meet your needs with professionalism, ability, precision and speed.

Every personalized product is a unique creation, tailored to tell the story of the one who chooses it, turning desire into reality.

Concevoir et réaliser des articles qui reflètent fidèlement vos besoins, vos goûts et vos désirs: c'est ce que Newform est capable d'offrir grâce à sa capacité de production 100 % Made in Italy.

Un service sur mesure qui façonne des produits capables de satisfaire les besoins avec le plus haut degré de personnalisation, alliant expérience et fiabilité à un design soigné et distinctif. Car c'est la seule façon que nous connaissons de suivre l'évolution du marché, en répondant toujours à vos demandes avec professionnalisme, méthode, précision et rapidité.

Das Entwerfen und Herstellen von Artikeln, die Ihre Bedürfnisse, Ihren Geschmack und Ihre Wünsche getreu widerspiegeln: das ist es, was Newform, dank seiner zu 100 % Made in Italy Produktionskapazität anbieten kann.

Ein "maßgeschneiderter" Service, der Produkte schmiedet, die in der Lage sind, die Bedürfnisse mit einem Höchstmaß an Personalisierung zu erfüllen, indem er Erfahrung und Zuverlässigkeit mit einem raffinierten und unverwechselbaren Design verbindet. Denn nur so können wir mit den Entwicklungen des Marktes Schritt halten und immer mit Professionalität, Methode, Präzision und Schnelligkeit auf Ihre Wünsche reagieren.

Jedes personalisierte Produkt ist ein Unikat, das maßgeschneidert ist, um die Geschichte derjenigen zu erzählen, die sich dafür entscheiden und sich einen Wunsch in die Realität umsetzen lassen.

Diseñar y realizar artículos que reflejen fielmente tus necesidades, tus gustos y tus deseos: esto es lo que Newform te ofrece gracias a su capacidad de producción 100% Made in Italy.

Un servicio a medida que forja productos capaces de satisfacer las necesidades con el más alto grado de personalización, combinando la experiencia y la fiabilidad con un diseño cuidado y distintivo. Porque esta es la única forma que conocemos de seguir el ritmo de las evoluciones del mercado, respondiendo siempre a tus necesidades con profesionalidad, método, precisión y rapidez.

Cada producto personalizado es una obra única, moldeada a medida para contar la historia de quien lo elige, convirtiendo el deseo en realidad.

newform





Newform crea e progetta allestimenti personalizzati per i clienti che desiderano esprimere l'identità del brand all'interno del proprio spazio. Corner funzionanti, giochi di luce e materiali pregiati fanno da cornice ai prodotti bagno, cucina e wellness. Le collezioni vengono proposte nelle molteplici finiture per esaltare il design delle forme e suggerire progetti innovativi e di tendenza. Newform propone un nuovo concept che rappresenta la filosofia del marchio con soluzioni che forniscono suggestioni nel progettare ambienti inediti.

Newform designs customized display stands for customers who wish to express the brand identity in their own spaces. Functional stands, plays of light and precious materials frame the bathroom, kitchen and wellness products.

Our collections in multiple finishes enhance the shape design and suggest innovative and trendy new projects. Newform offers a new concept that represents the brand philosophy with solutions that provide suggestions in designing new spaces.

Newform crée et conçoit des aménagements sur mesure pour les clients souhaitant exprimer l'identité de la marque dans leur propre espace. Des corners fonctionnels, des jeux de lumière et des matériaux précieux encadrent les produits de salle de bains, de cuisine et du bien-être. Les collections sont proposées dans de multiples finitions pour exalter le design des formes et suggérer des projets innovants et tendance. Newform propose un nouveau concept qui représente la philosophie de la marque avec des solutions qui fournissent des suggestions pour concevoir des espaces inédits.

Newform schafft und gestaltet maßgeschneiderte Einrichtungen für Kunden, die ihre Markenidentität in ihrem Raum zum Ausdruck bringen möchten. Funktionierende Ecken, Lichtspiele und edle Materialien rahmen die Bade-, Küchen- und Wellnessprodukte ein. Die Kollektionen werden in verschiedenen Oberflächen Ausführungen angeboten, um das Design der Formen herauszuheben und innovative und trendige Projekte vorzuschlagen. Newform präsentiert ein neues Konzept, das die Philosophie der Marke repräsentiert und Lösungen bietet, um neue Umgebungen zu gestalten.

Diseñar y realizar artículos que reflejen fielmente tus necesidades, tus gustos y tus deseos: esto es lo que Newform te ofrece gracias a su capacidad de producción 100% Made in Italy.

Un servicio a medida que forja productos capaces de satisfacer las necesidades con el más alto grado de personalización, combinando la experiencia y la fiabilidad con un diseño cuidado y distintivo. Porque esta es la única forma que conocemos de seguir el ritmo de las evoluciones del mercado, respondiendo siempre a tus necesidades con profesionalidad, método, precisión y rapidez.

Cada producto personalizado es una obra única, moldeada a medida para contar la historia de quien lo elige, convirtiendo el deseo en realidad.

EXPO WALL

A2:
32 x 225 cm

B:
48 x 225 cm

C:
64 x 225 cm

D:
64 x 225 cm



- NERO OPACO
- MATT BLACK
- NOIR MAT
- SCHWARZMATT
- NEGRO MATE

- ORO SPAZZOLATO
- BRUSHED GOLD
- OR BROSSÉ
- GOLD BRONZE
- ORO CEPILLADO



Questi espositori devono necessariamente essere fissati a una parete esistente.

This expo must be fixed to an existing wall.

Ces présentoirs doivent obligatoirement être fixés sur une paroi existante.

Diese Ausstellungsstücke müssen unbedingt an einer vorhandenen Wand befestigt werden.

Estos expositores deben fijarse necesariamente a una pared existente.

F:
64 x 225 cm

E:
64 x 225 cm

E:
64 x 225 cm

A2:
32 x 225 cm

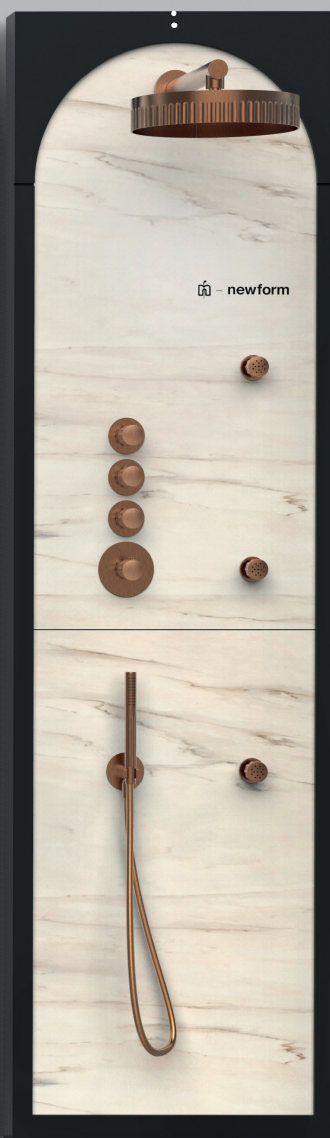
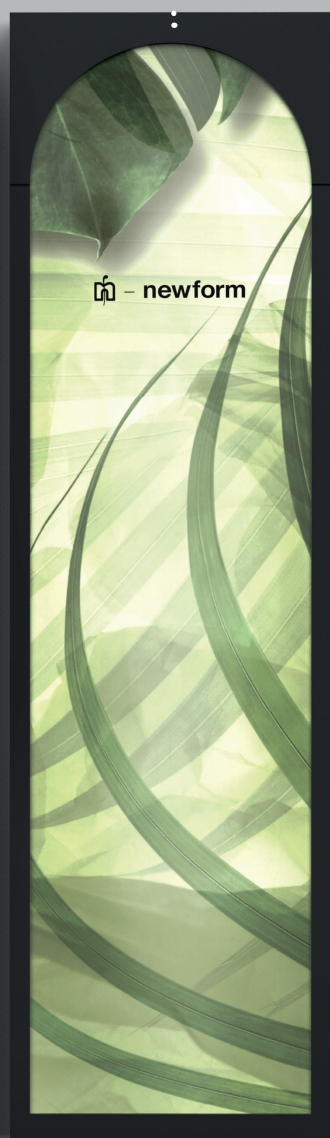

• PANNELLO RETROILLUMINATO
• BACKLIGHT PANEL
• PANNEAU RÉTROÉCLAIRÉ
• HINTERGRUNDBELEUCHTETES PANEL
• PANEL RETROILUMINADO

• ORO SPAZZOLATO
• BRUSHED GOLD
• OR BROSSÉ
• GOLD BRONZE
• ORO CEPILLADO

• NERO OPACO
• MATT BLACK
• NOIR MAT
• SCHWARZMATT
• NEGRO MATE

DISPLAY SYSTEMS

EXPO STANDARD

Expo standard è progettato per l'esposizione di:

- 3 miscelatori monoforo;
- 1 gruppo lavabo tre fori da appoggio;
- 1 gruppo lavabo a parete;
- 1 placca comando wc;
- 6 accessori;
- 1 kit doploncini finiture;

I lavabi vengono forniti su basetta e kit di fissaggio. È possibile personalizzare l'espositore scegliendo tra i prodotti di pag. 18/19.

Expo standard ist für die Ausstellung von:

- 3 Stk. 1 Loch-Waschtischmischer;
- 1 Stk. 3-Loch Wandmontage Waschtischarmatur;
- 1 Stk. Wandmontage Waschtischarmatur;
- 1 Stk. WC Bestätigungsplatte
- 6 Stk. Accessoires;
- 1 Satz Dublonen Oberflächenausführung;

Die Waschtisch Armaturen werden mit Sockel und Montage Set geliefert.

Der Aussteller lässt sich durch Auswahl der Produkte auf den Seiten 18/19 personalisieren.

Expo standard is designed for the display of:

- 3 single lever basin mixers;
- one 3-hole basin group;
- one wall-mounted basin mixer;
- one toilet flush plate;
- 6 accessories;
- 1 small doubloons finishing kit;

Basin mixers are supplied with plexiglass bases and wall-mounted mixers with proper fixing kits.

To customize the expo stand please refer to page 18/19 and choose from the listed products.

Expo estándar está diseñado para la exposición de:

- 3 mezcladores monomando;
- 1 grupo de lavabo con tres orificios de apoyo;
- 1 grupo de lavabo de pared;
- 1 placa de control del inodoro;
- 6 accesorios;
- 1 kit doblones pequeños acabados;

los lavabos se suministran sobre soporte y kit de fijación. Es posible personalizar el expositor eligiendo entre los productos de la pág. 18/19.

Expo standard conçu pour l'exposition de:

- 3 mitigeurs à seul trou;
- 1 groupe lavabo trois trous à poser;
- 1 groupe lavabo mural;
- 1 plaque de commande wc;
- 6 accessoires;
- 1 kit doublons finitions;

Les lavabos sont fournis avec une base et un kit de fixation.

Il est possible de personnaliser le présentoir en choisissant parmi les produits aux pages 18/19.





Vista laterale:
 Side view:
 Vue latérale:
 Seitenansicht:
 Vista lateral:

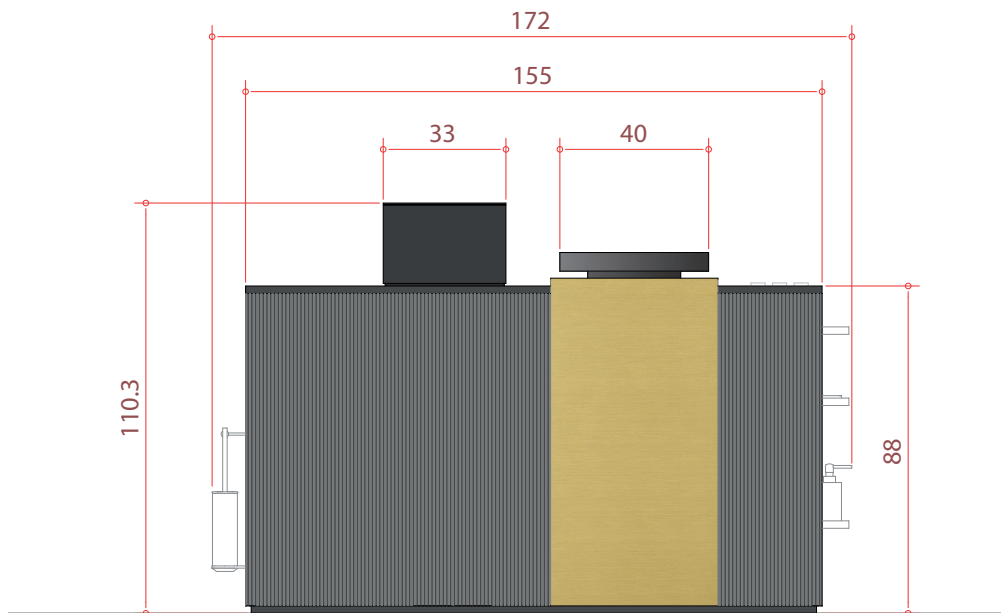

Vista in pianta:
 Plan view:
 Vue en plan:
 Draufsicht:
 Vista en planta:

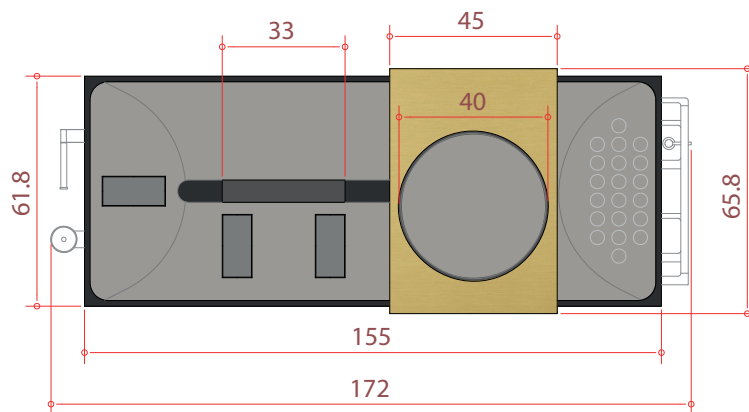



DELTA ZERO
72212DD.58.063
€ 100,00



DELTA ZERO
72215DD.59.067
€ 130,00



HAKA
72012DD.59.066
€ 100,00



HAKA
72012DD.59.067
€ 100,00



HAKA
72015DD.59.097
€ 130,00



BLINK CHIC luxury
71112DD.58.061
€ 100,00



NIO
68912DD.01.093
€ 60,00



NIO
68915DD.59.066
€ 130,00



O'RAMA
68412DD.M2.071
€ 60,00



O'RAMA
68415DD.05.093
€ 75,00



X-STEEL 316
69612XDD.50.050
€ 60,00



X-STEEL 316
69612XDD.59.097
€ 100,00



X-STEEL 316
69612XDD.59.098
€ 100,00



X-STEEL 316
69614XDD.59.064
€ 120,00



X-STEEL 316
69614XDD.59.067
€ 120,00



X-STEEL 316
69615XDD.59.098
€ 130,00



XT
4208DD.M0.077
€ 60,00



XT
4208DD.01.093
€ 60,00



XT
4208DD.21.018
€ 50,00



X-WAY
73912DD.47.083
€ 100,00



X-WAY
73912DD.21.018
€ 50,00



X-WAY
73912DD.01.093
€ 60,00



X-WAY
73914DD.59.064
€ 120,00



X-WAY
73915DD.M0.075
€ 105,00



B-EASY
72612DD.21.018
€ 50,00



B-EASY
72612DD.01.093
€ 60,00



B-EASY
72612DD.M0.072
€ 60,00



B-EASY
72614DD.M0.070
€ 85,00



B-EASY
72615DD.M0.071
€ 105,00



LINFA II
69412DD.21.018
€ 50,00



LINFA II
69412DD.M0.075
€ 60,00



ERGO-Q
66412DD.21.018
€ 50,00

LAVABO 3 FORI APPOGGIO / 3-HOLE WASHBASIN GROUP / LAVABOS 3 TROUS À POSER / 3-LOCH WASCHTISCHARMATUR / LAVABO CON 3 ORIFICIOS DE APOYO

completi di basetta / on plexiglass base / dotés d'une base / Die Waschtisch Armaturen werden mit Sockel / dotados de soporte



DELTA ZERO

72200DD.61.020
€ 150,00

BLINK

70801DD.01.093
€ 120,00

NIO

68901DD.59.097
€ 150,00

LAVABO PARETE / WALL-MOUNTED WASHBASIN MIXER / LAVABOS MURAUX / WANDMONTAGE WASCHTISCHARMATUR / LAVABO DE PARED

completi di kit fissaggio / with fixing kit / doté d'un kit de fixation / Die Waschtisch Armaturen mit Montage Set geliefert / completo con kit de fijación



DELTA ZERO

72229E.61.020
€ 90,00

HAKA

72028E.59.097
€ 90,00

BLINK

70820E.47.083
€ 90,00

X-STEEL 316

69630EX.50.050
€ 60,00

X-WAY

73928E.01.093
€ 60,00

ACCESSORI / ACCESSORIES / ACCESSOIRES / ACCESSOIRES / ACCESORIOS

TONDI / ROUND / ROND / RUND / REDONDOS



● 67201.M0.075
€ 35,00



● 67205.M0.075
€ 40,00



● 67210.M0.075
€ 55,00



67227.M0.075
cm. 30
€ 65,00



67223.M0.075
€ 30,00



● 67215.M0.075
€ 60,00

QUADRI / SQUARE / CARRÉ / QUADRATISCH / CUADRADOS



● 62901.01.093
€ 35,00



● 62905.01.093
€ 40,00



● 62910.01.093
€ 55,00



62927.01.093
cm. 30
€ 65,00



62923.01.093
€ 30,00



● 62965.01.093
€ 60,00

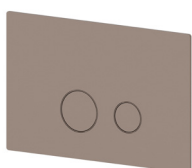

883.M0.075
€ 150,00

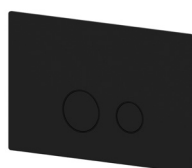

883.01.093
€ 150,00

● CERAMICA BIANCA / WHITE CERAMIC
CÉRAMIQUE BLACHE / WEIßE KERAMIK / CERÁMICA BLANCA

● CERAMICA NERA / BLACK CERAMIC
CÉRAMIQUE NOIRE / SCHWARZE KERAMIK / CERÁMICA NEGRA

EX235.00.000

6.700,00 €

Espositore vuoto - Empty display
Présentoir vide - Leerer Ausstellungsständer - Expositor vacío

WORK TABLE

Il tavolo da lavoro è pensato come un continuum dell'esperienza espositiva, utile a guidare il cliente nel processo di vendita.

E' un tavolo di confronto e ragionamento, un supporto che aiuta a rendere concreta un'idea o un progetto tramite l'ausilio di basette e prodotti Newform selezionabili dall'elenco di pag. 22/23.

Der Arbeitstisch ist als Kontinuum des Ausstellungs-Erlebnisses konzipiert, das nützlich ist, um den Kunden im Verkaufsprozess zu führen.

Es ist ein Tisch der Diskussionen und Argumentationen, eine Unterstützung, die hilft, eine Idee oder ein Projekt mit Hilfe von Grundlagen und Newform-Produkten zu konkretisieren, die aus der Liste auf Seite 22/23 ausgewählt werden können.

The work table was conceived as a continuum of the display experience, useful to guide the customer throughout the sales process.

As a table for comparison and reasoning, it supports confirmation of an idea or a project with the aid of Newform bases and products selectable from the list on page 22/23.

La mesa de trabajo está pensada como un continuum de la experiencia expositiva, útil para guiar al cliente en el proceso de venta.

Es una mesa de intercambio y razonamiento, un soporte que ayuda a concretar una idea o un proyecto con la ayuda de soportes y productos Newform seleccionables de la lista de la pág. 22/23.

La table de travail est conçue comme le continuum de l'expérience d'exposition, utile pour guider le client durant le processus de vente.

Il s'agit d'une table de confrontation et de réflexion, un support qui aide à rendre une idée ou un projet concret grâce à des bases et produits Newform qui peuvent être sélectionnés dans la liste des pages 22/23.



kit dobloncini finiture / small doubloons finishing kit
kit doublons finitions / Satz Dublonen Oberflächenausführung
kit doblones pequeños acabados



Vista laterale:
 Side view:
 Vue latérale:
 Seitenansicht:
 Vista lateral:

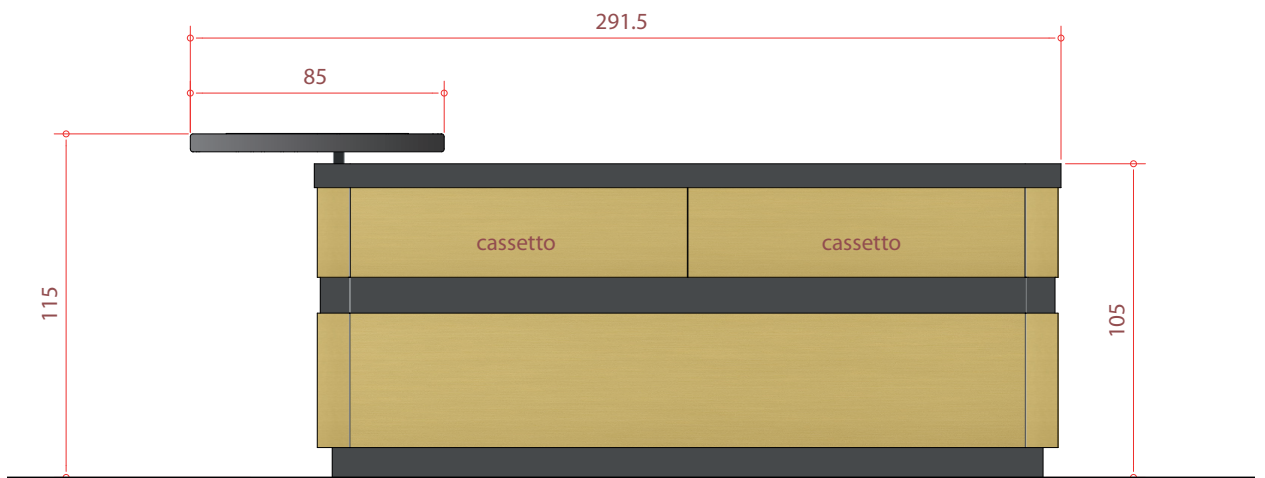

Vista in pianta:
 Plan view:
 Vue en plan:
 Draufsicht:
 Vista en planta:

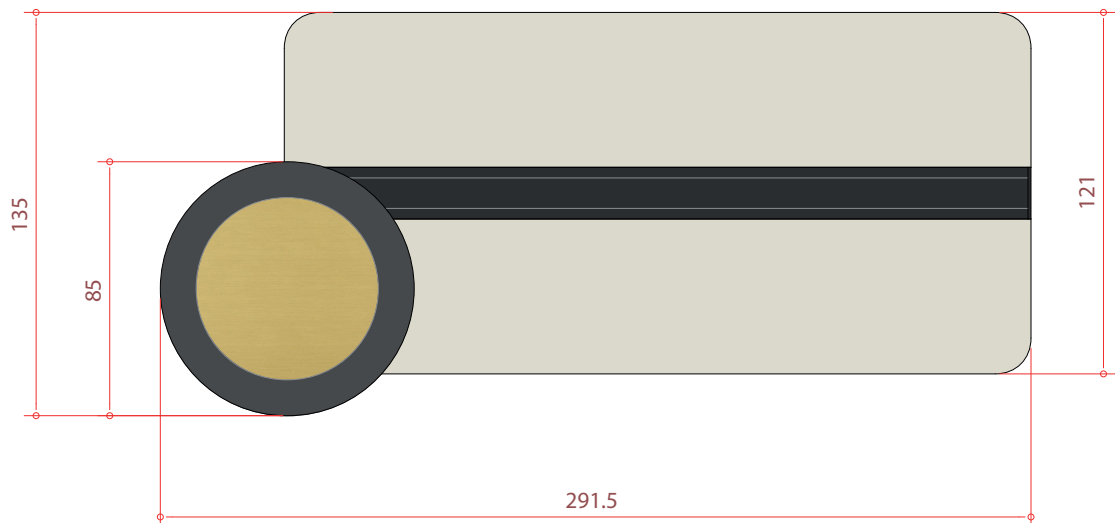



DELTA ZERO
72212DD.58.063
€ 100,00



DELTA ZERO
72215DD.59.067
€ 130,00



HAKA
72012DD.59.066
€ 100,00



HAKA
72012DD.59.067
€ 100,00



HAKA
72015DD.59.097
€ 130,00



BLINK CHIC luxury
71112DD.58.061
€ 100,00



NIO
68912DD.01.093
€ 60,00



NIO
68915DD.59.066
€ 130,00



O'RAMA
68412DD.M2.071
€ 60,00



O'RAMA
68415DD.05.093
€ 75,00



X-STEEL 316
69612XDD.50.050
€ 60,00



X-STEEL 316
69612XDD.59.097
€ 100,00



X-STEEL 316
69612XDD.59.098
€ 100,00



X-STEEL 316
69614XDD.59.064
€ 120,00



X-STEEL 316
69614XDD.59.067
€ 120,00



X-STEEL 316
69615XDD.59.098
€ 130,00



XT
4208DD.M0.077
€ 60,00



XT
4208DD.01.093
€ 60,00



XT
4208DD.21.018
€ 50,00



X-WAY
73912DD.47.083
€ 100,00



X-WAY
73912DD.21.018
€ 50,00



X-WAY
73912DD.01.093
€ 60,00



X-WAY
73914DD.59.064
€ 120,00



X-WAY
73915DD.M0.075
€ 105,00



B-EASY
72612DD.21.018
€ 50,00



B-EASY
72612DD.01.093
€ 60,00



B-EASY
72612DD.M0.072
€ 60,00



B-EASY
72614DD.M0.070
€ 85,00



B-EASY
72615DD.M0.071
€ 105,00



LINFA II
69412DD.21.018
€ 50,00



LINFA II
69412DD.M0.075
€ 60,00



ERGO-Q
66412DD.21.018
€ 50,00



DELTA ZERO

72200DD.61.020
€ 150,00

BLINK

70801DD.01.093
€ 120,00

NIO

68901DD.59.097
€ 150,00

ACCESSORI / ACCESSORIES / ACCESSOIRES / ACCESSOIRES / ACCESORIOS

TONDI / ROUND / ROND / RUND / REDONDOS



● 67201.M0.075
€ 35,00



● 67205.M0.075
€ 40,00



● 67210.M0.075
€ 55,00



67227.M0.075
cm. 30
€ 65,00



67223.M0.075
€ 30,00



● 67215.M0.075
€ 60,00

QUADRI / SQUARE / CARRÉ / QUADRATISCH / CUADRADOS



● 62901.01.093
€ 35,00



● 62905.01.093
€ 40,00



● 62910.01.093
€ 55,00



62927.01.093
cm. 30
€ 65,00



62923.01.093
€ 30,00



● 62965.01.093
€ 60,00

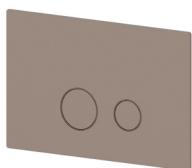

883.M0.075
€ 150,00

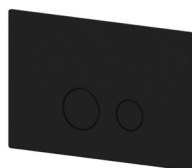

883.01.093
€ 150,00

● CERAMICA BIANCA / WHITE CERAMIC
CÉRAMIQUE BLACHE / WEIßE KERAMIK / CERÁMICA BLANCA

● CERAMICA NERA / BLACK CERAMIC
CÉRAMIQUE NOIRE / SCHWARZE KERAMIK / CERÁMICA NEGRA

EXPO **B** MULTISERIE

Expo B Multiserie è progettato per l'esposizione di:

- 3 miscelatori monoforo;
- 1 gruppo lavabo tre fori da appoggio;
- 1 miscelatore a parete;

I lavabi vengono forniti su basetta e kit di fissaggio. E' possibile personalizzare l'espositore scegliendo tra i prodotti di pag. 26/27.

Expo B Multiserie ist für die Ausstellung von:

- 3 St. 1-Loch Waschtischarmatur;
- 1 St. 3-Loch Waschtischarmatur;
- 1 St. Wandmischer

Die Waschtisch Armaturen werden mit Sockel und Montage Set geliefert.

Der Aussteller lässt sich durch Auswahl der Produkte auf den Seiten 30/31 personalisieren.

Expo B Multiseries is designed for the display of:

- 3 single lever basin mixers;
- one 3-hole basin group;
- 1 wall mixer;

Basin mixers are supplied with plexiglass bases and wall-mounted mixers with proper fixing kits. To customize the expo stand please refer to page 26/27 and choose from the listed products.

Expo B Multiserie está diseñado para la exposición de:

- 3 mezcladores monomando;
- 1 grupo de lavabo con tres orificios de apoyo;
- 1 mezclador de pared;

Los lavabos se suministran sobre soporte y kit de fijación. Es posible personalizar el expositor eligiendo entre los productos de la pág. 26/27.

Expo B Multiserie conçu pour l'exposition de:

- 3 mitigeurs à seul trou;
- 1 groupe lavabo trois trous à poser;
- 1 mitigeur muraux;

Les lavabos sont fournis avec une base et un kit de fixation.

Il est possible de personnaliser le présentoir en choisissant parmi les produits aux pages 26/27.

Vista laterale:
Side view:
Vue latérale:
Seitenansicht:
Vista lateral:

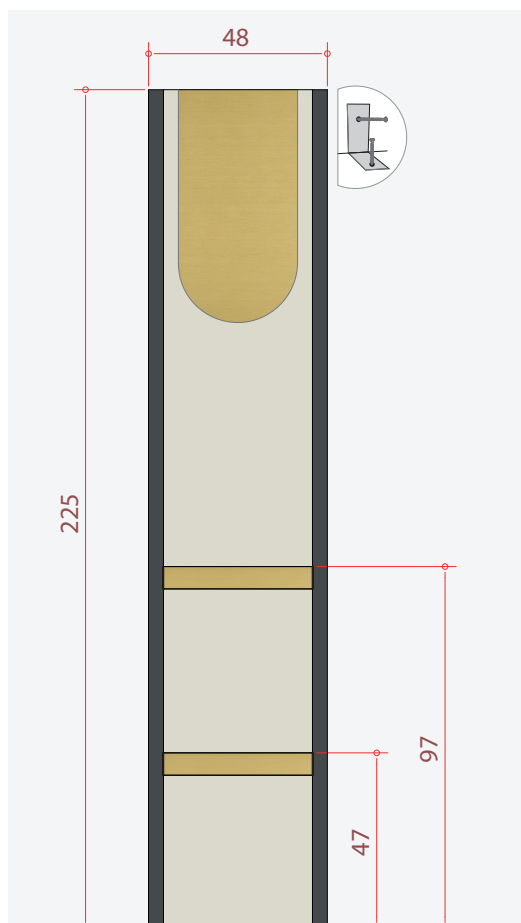

Vista in pianta:
Plan view:
Vue en plan:
Draufsicht:
Vista en planta:

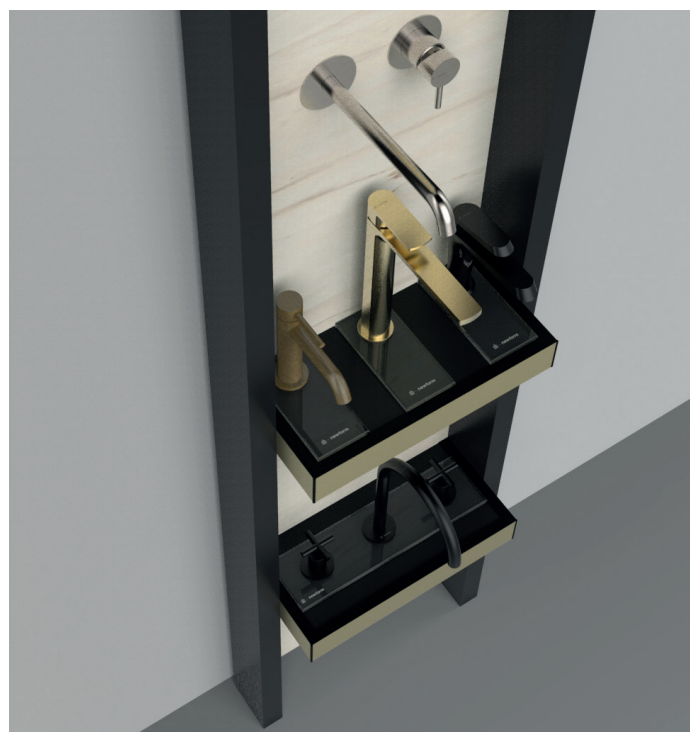
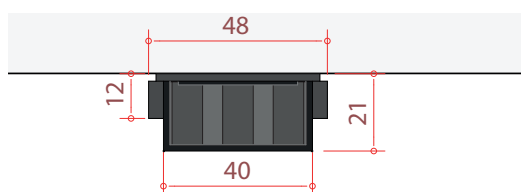

newform

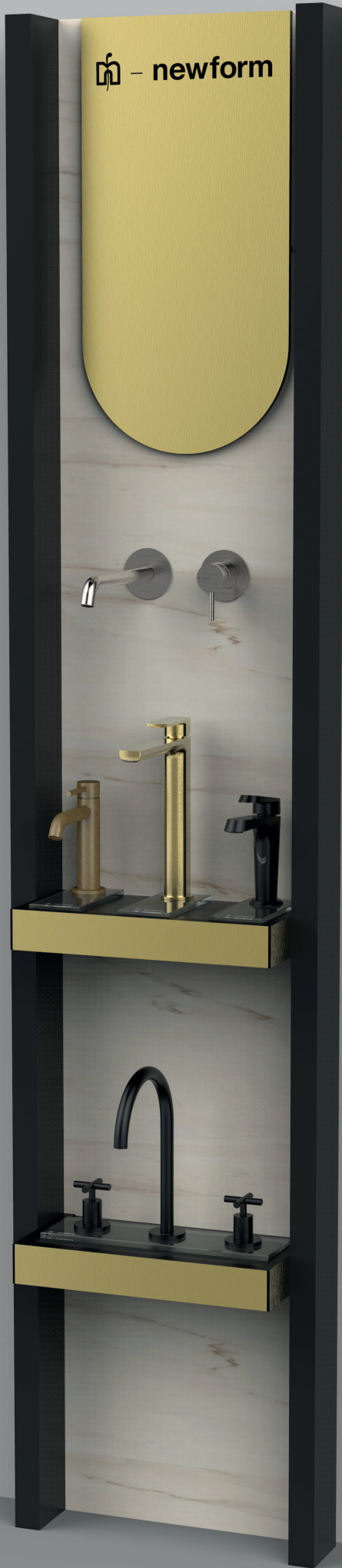



DELTA ZERO
72212DD.58.063
€ 100,00



DELTA ZERO
72215DD.59.067
€ 130,00



HAKA
72012DD.59.066
€ 100,00



HAKA
72012DD.59.067
€ 100,00



HAKA
72015DD.59.097
€ 130,00



BLINK CHIC luxury
71112DD.58.061
€ 100,00



NIO
68912DD.01.093
€ 60,00



NIO
68915DD.59.066
€ 130,00



O'RAMA
68412DD.M2.071
€ 60,00



O'RAMA
68415DD.05.093
€ 75,00



X-STEEL 316
69612XDD.50.050
€ 60,00



X-STEEL 316
69612XDD.59.097
€ 100,00



X-STEEL 316
69612XDD.59.098
€ 100,00



X-STEEL 316
69614XDD.59.064
€ 120,00



X-STEEL 316
69614XDD.59.067
€ 120,00



X-STEEL 316
69615XDD.59.098
€ 130,00



XT
4208DD.M0.077
€ 60,00



XT
4208DD.01.093
€ 60,00



XT
4208DD.21.018
€ 50,00



X-WAY
73912DD.47.083
€ 100,00



X-WAY
73912DD.21.018
€ 50,00



X-WAY
73912DD.01.093
€ 60,00



X-WAY
73914DD.59.064
€ 120,00



X-WAY
73915DD.M0.075
€ 105,00



B-EASY
72612DD.21.018
€ 50,00



B-EASY
72612DD.01.093
€ 60,00



B-EASY
72612DD.M0.072
€ 60,00



B-EASY
72614DD.M0.070
€ 85,00



B-EASY
72615DD.M0.071
€ 105,00



LINFA II
69412DD.21.018
€ 50,00



LINFA II
69412DD.M0.075
€ 60,00



ERGO-Q
66412DD.21.018
€ 50,00

LAVABO 3 FORI APPOGGIO / 3-HOLE WASHBASIN GROUP / LAVABOS 3 TROUS À POSER / 3-LOCH WASCHTISCHARMATUR / LAVABO CON 3 ORIFICIOS DE APOYO

completi di basetta / on plexiglass base / dotés d'une base / Die Waschtisch Armaturen werden mit Sockel / dotados de soporte



DELTA ZERO

72200DD.61.020

€ 150,00

BLINK

70801DD.01.093

€ 120,00

NIO

68901DD.59.097

€ 150,00

LAVABO PARETE / WALL-MOUNTED WASHBASIN MIXER / LAVABOS MURAUX / WANDMONTAGE WASCHTISCHARMATUR / LAVABO DE PARED

completi di kit fissaggio / with fixing kit / doté d'un kit de fixation / Die Waschtisch Armaturen mit Montage Set geliefert / completo con kit de fijación



DELTA ZERO

72229E.61.020

€ 90,00

HAKA

72028E.59.097

€ 90,00

BLINK

70820E.47.083

€ 90,00

X-STEEL 316

69630EX.50.050

€ 60,00

X-WAY

73928E.01.093

€ 60,00

EX243.00.000

1.490,00 €

Completo di articoli - *Products included*
Expo complet avec des articles - *Display mit Produkte* - Completo con artículos

EXPO **E** WELLNESS

Expo Wellness è progettato per l'esposizione di:

Expo Wellness is designed for the display of:

Expo Wellness conçu pour l'exposition de:

Expo Wellness ist für die Ausstellung von:

Expo Wellness está diseñado para la exposición de:

- 27667.M0.071 Braccio soffione a parete tondo L 300 mm GOLD SATIN
Round wall-mounted shower arm L=300 mm GOLD SATIN
Bras de douche rond L 300 mm GOLD SATIN
Runder Wandbrausearm L=300 mm GOLD SATIN
Brazo cabezal de ducha de pared redondo L 300 mm GOLD SATIN
- 27747.M0.071 Soffione tondo ø 250 mm GOLD SATIN
Round head shower ø 250mm GOLD SATIN
Douche de tête ronde ø 250 mm GOLD SATIN
Rundkopfbrause ø 250mm GOLD SATIN
Cabezal redondo ø 250 mm GOLD SATIN
- 67556.M0.071 Asta saliscendi GOLD SATIN
Shower set GOLD SATIN
Barre de douche GOLD SATIN
Brausestange GOLD SATIN
Barras de ducha deslizantes GOLD SATIN
- 68499.M0.071 Presa acqua GOLD SATIN
Wall union GOLD SATIN
Prise d'eau GOLD SATIN
Wasseranschluss GOLD SATIN
Toma de agua GOLD SATIN
- 67638E.M0.071 Comando termostatico con deviatore GOLD SATIN
Thermostatic concealed mixer
Commande thermostatique avec inverseur GOLD SATIN
Thermostatische Mischbatterie mit Umschalter, GOLD SATIN
Mando termostático con desviador GOLD SATIN
- 69680EX.50.050 Gruppo vasca a parete in ACCIAIO INOX
Bath group STAINLESS STEEL
Groupe baignoire mural en ACIER INOX
Wandarmatur für Badewanne aus EDELSTAHL INOX
Grifería de pared para bañera GOLD SATIN

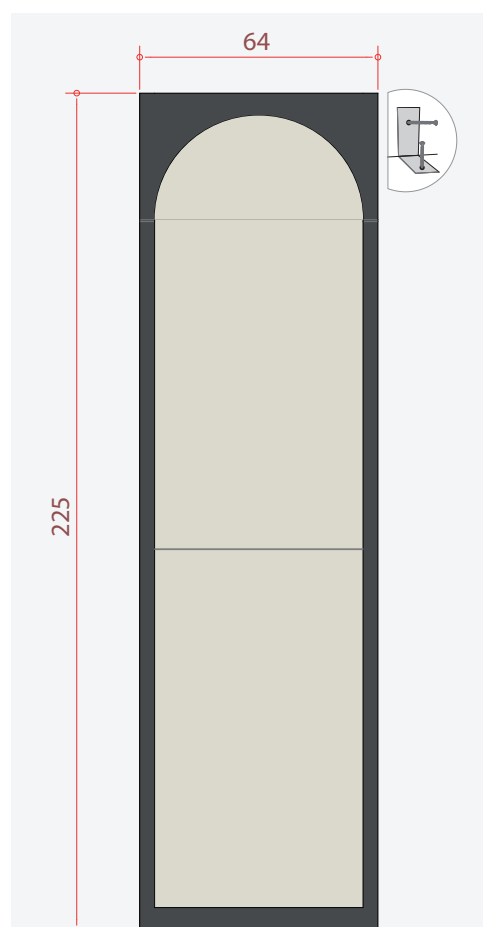

Vista laterale:
Side view:
Vue latérale:
Seitenansicht:
Vista lateral:

Vista in pianta:
Plan view:
Vue en plan:
Draufsicht:
Vista en planta:

Centimetri - *Centimetres*
Centimètres - *Zentimeter* - *Centímetros*



newform

EX238.00.000 BLACK 755,00 €

EX239.00.000 GOLD 875,00 €

Completo di articoli - Products included
Expo complet avec des articles - Display mit Produkte
Completo con artículos

EXPO **A1** COLONNA DOCCIA / SHOWER COLUMN / COLONNE DE DOUCHE
DUSCHSÄULE / COLUMNNA DE DUCHA

- 61165.01.014 Colonna doccia tonda termostatica BIANCO OPACO
Round shower column with exposed thermostatic mixer MATT WHITE
Colonne douche ronde thermostatique BLANC MAT
Runde thermostatische Duschsäule WEISSMATT
Columnna de ducha redonda termostática BLANCO MATE

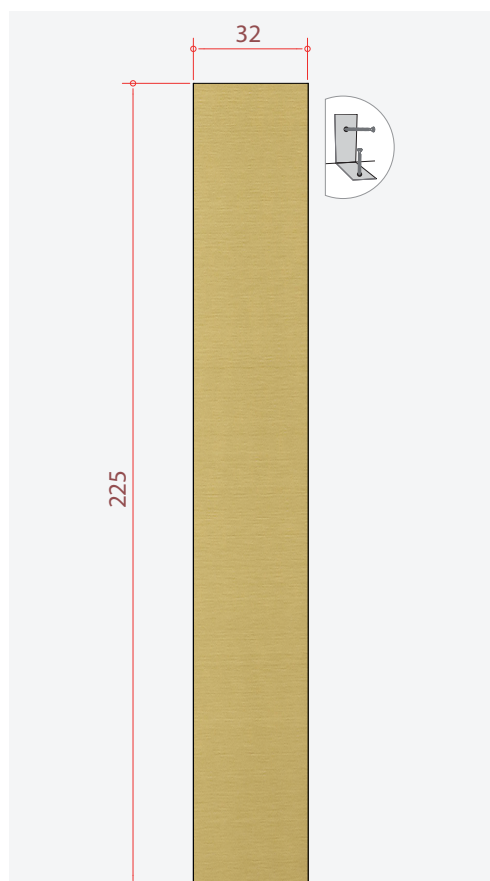

Vista laterale:
Side view:
Vue latérale:
Seitenansicht:
Vista lateral:

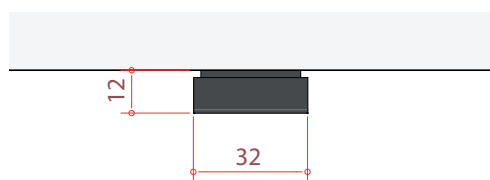

Vista in pianta:
Plan view:
Vue en plan:
Draufsicht:
Vista en planta:

Centimetri - Centimetres
Centimètres - Zentimeter - Centímetros



EX238.00.000 BLACK 900,00 €
 EX239.00.000 GOLD 1.020,00 €

Completo di articoli - Products included
 Expo complet avec des articles - Display mit Produkte
 Completo con artículos

EXPO **A1** DOCCIA / SHOWER / DOUCHE / DUSCHBE / DUCHA

- 29390X.59.098 Braccio soffione a parete in acciaio INOX L=350 mm BRUSHED PALE GOLD
 Stainless steel wall-mounted shower arm L=350 mm BRUSHED PALE GOLD
 Bras de douche mural en acier INOX L=350 mm BRUSHED PALE GOLD
 Runder Wandbrausearm aus edelstahl L=350 mm BRUSHED PALE GOLD
 Brazo cabezal de ducha de pared en acero INOXIDABLE L=350 mm BRUSHED PALE GOLD
- 29392X.59.098 Soffione tondo in acciaio INOX ø 250 mm BRUSHED PALE GOLD
 Stainless steel head shower ø 250mm BRUSHED PALE GOLD
 Pommeau rond en acier INOX ø 250 mm BRUSHED PALE GOLD
 Runder Duschkopf aus Stahl mit Regenstrahl, ø 250 mm brushed PALE GOLD
 Cabezal redondo en acero INOXIDABLE ø 250 mm BRUSHED PALE GOLD
- 70426EX.59.098 Thermo Easy in acciaio INOX 2 uscite BRUSHED PALE GOLD con parte incasso
 • + 27751.00.000 Stainless steel Thermo Easy 2 ways-out BRUSHED PALE GOLD with concealed part
 Thermo Easy en acier INOX 2 sorties BRUSHED PALE GOLD avec partie encastrée
 Thermo Easy aus Stahl 2 Ausgänge BRUSHED PALE GOLD mit Einbauteil
 Thermo Easy en acero INOXIDABLE 2 salidas BRUSHED PALE GOLD con parte empotrada
- 69645X.59.098 Set doccia completo in acciaio INOX BRUSHED PALE GOLD
 Stainless steel complete shower set BRUSHED PALE GOLD
 Set douche complet en acier INOX brushed PALE GOLD
 Komplettes Duschset aus gebürstetem EDELSTAHL PALE GOLD
 Juego de ducha completo en acero INOXIDABLE BRUSHED PALE GOLD

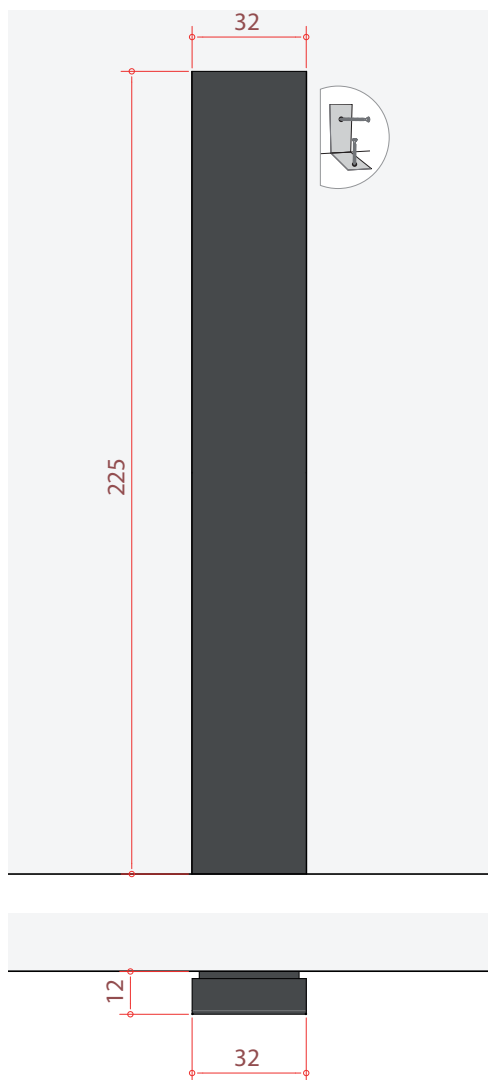

Vista laterale:
 Side view:
 Vue latérale:
 Seitenansicht:
 Vista lateral:

Vista in pianta:
 Plan view:
 Vue en plan:
 Draufsicht:
 Vista en planta:

Centimetri - Centimetres
 Centimètres - Zentimeter - Centímetros



EX237.00.000

510,00 €

Completo di articoli - Products included
Expo complet avec des articles - Display mit Produkte - Completo con artículos

EXPO THERMO EASY

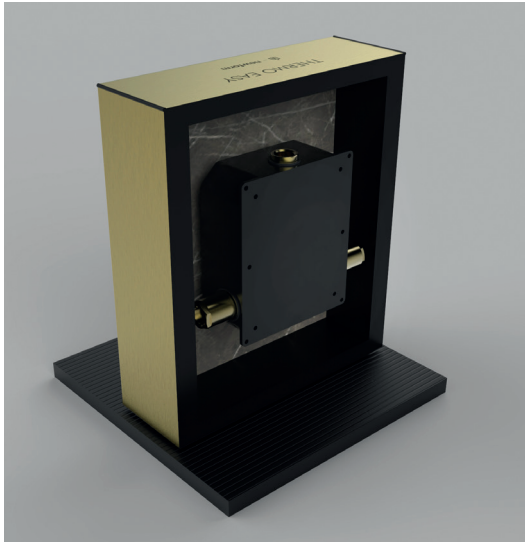

2 USCITE / 2 WAYS OUT
2 SORTIES / 2 WEGE / 2 SALIDAS



X-STEEL
70426EX.59.098



X-STEEL
27751.00.000

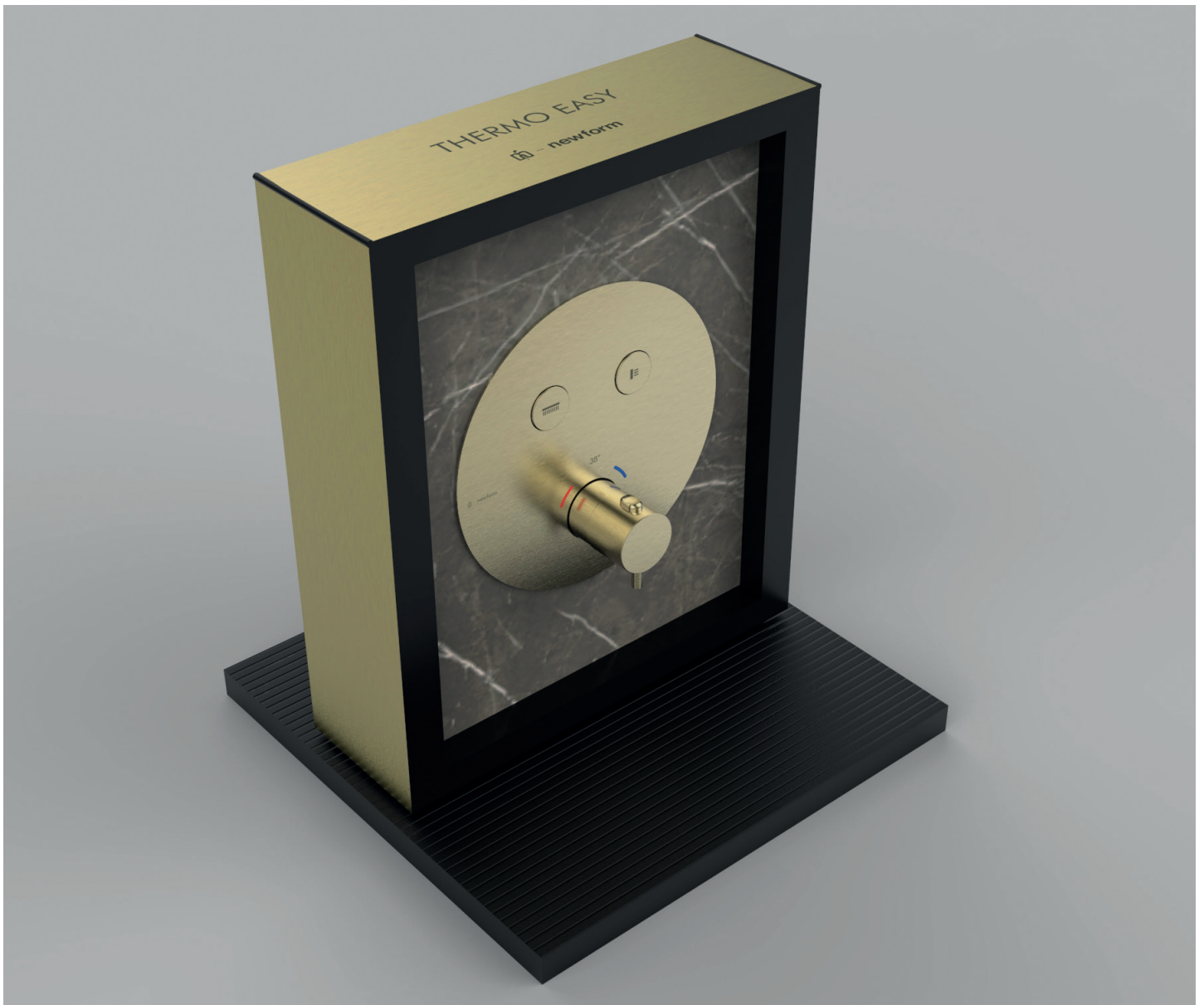



newform

newform

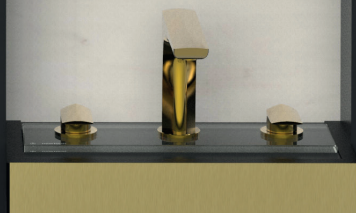
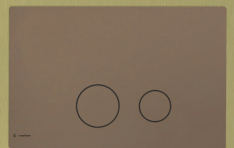

EX238.00.000 BLACK 595,00 €

EX239.00.000 GOLD 715,00 €

Completo di articoli - Products included
Expo complet avec des articles - Display mit Produkte
Completo con artículos

EXPO **A2** ACCESSORI / ACCESSORIES / ACCESSOIRES / ACCESSOIRES / ACCESORIOS

TONDI / ROUND / ROND / RUND / REDONDOS



● 67201.M0.075



● 67205.M0.075



● 67210.M0.075



67223.M0.075



● 67215.M0.075

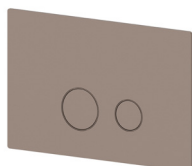

883.M0.075

● CERAMICA BIANCA / WHITE CERAMIC
CÉRAMIQUE BLACHE / WEIßE KERAMIK / CERÁMICA BLANCA

● CERAMICA NERA / BLACK CERAMIC
CÉRAMIQUE NOÏRE / SCHWARZE KERAMIK / CERÁMICA NEGRA

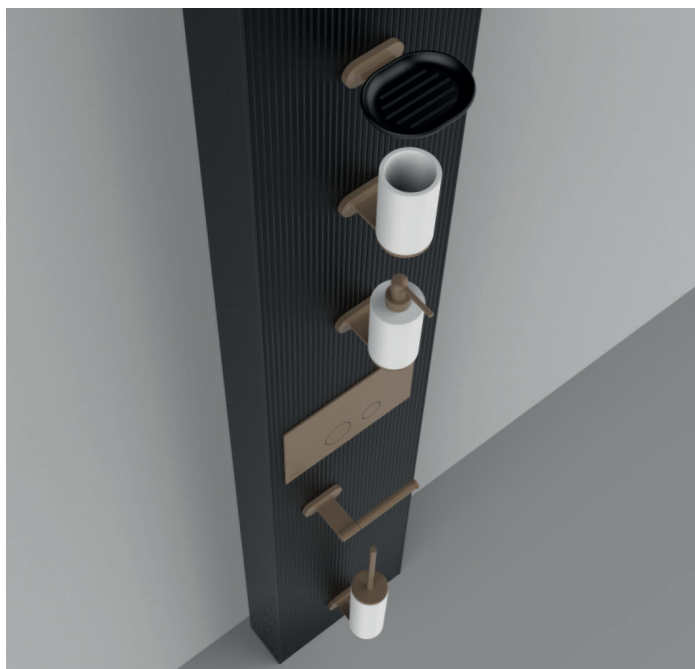

EX238.00.000 BLACK 595,00 €

EX239.00.000 GOLD 715,00 €

Completo di articoli - Products included
Expo complet avec des articles - Display mit Produkte
Completo con artículos

EXPO **A2** ACCESSORI / ACCESSORIES / ACCESSOIRES / ACCESSOIRES / ACCESORIOS

QUADRI / SQUARE / CARRÉ / QUADRATISCH / CUADRADOS



62901.01.093



62905.01.093



62910.01.093



62923.01.093



62965.01.093



883.01.093

● CERAMICA BIANCA / WHITE CERAMIC
CÉRAMIQUE BLACHE / WEIßE KERAMIK / CERÁMICA BLANCA

● CERAMICA NERA / BLACK CERAMIC
CÉRAMIQUE NOIRE / SCHWARZE KERAMIK / CERÁMICA NEGRA

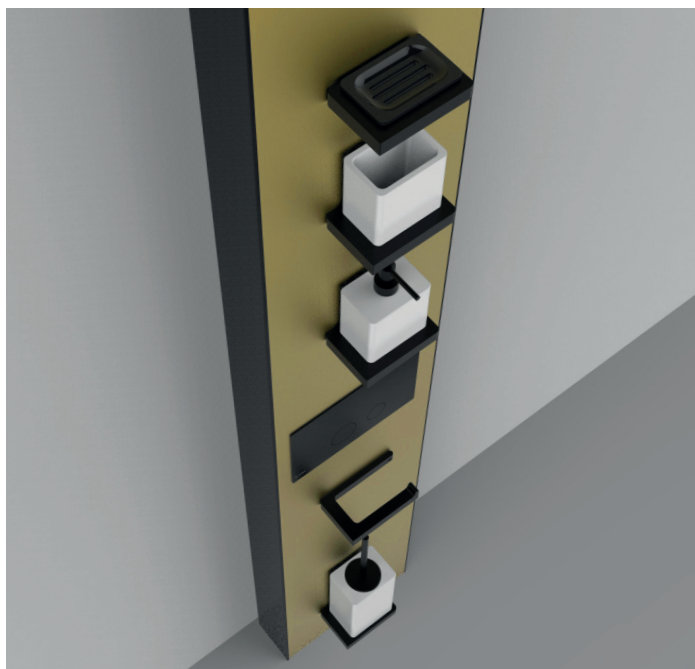

EX238.00.000 BLACK 965,00 €

EX239.00.000 GOLD 1.085,00 €

Completo di articoli - Products included
Expo complet avec des articles - Display mit Produkte
Completo con artículos

EXPO **A2** ACCESSORI X-STEEL / ACCESSOIRES X-STEEL / ACCESSOIRES X-STEEL
ACCESSOIRES X-STEEL / ACCESORIOS X-STEEL

X-STEEL



73201X.59.067



73209X.59.064



73204X.59.097



73223X.59.067



73215X.59.098

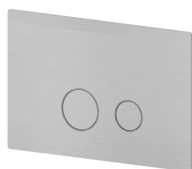

69643X.50.050





ព័ - newform

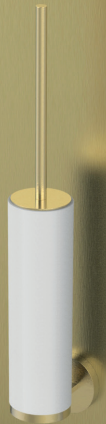
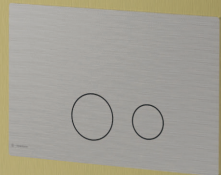
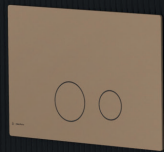

EX242.00.000

560,00 €

Espositore vuoto - Empty display
Présentoir vide - Leerer Ausstellungsständer - Expositor vacío

EXPO **D** MINI

Expo Mini Ambientazione è progettato per l'esposizione di:

- 1 gruppo lavabo a parete;
- 2 accessori a parete;
- 1 finto lavabo freestanding EX252.00.000.

I lavabi vengono forniti con kit di fissaggio. È possibile personalizzare l'espositore scegliendo tra i prodotti di pag. 41.

Expo Mini Ambiente ist konzipiert für die Ausstellung von:

- 1 wandmontierter Waschtischmischer;
- 2 Wandzubehör;
- 1 freihstehendes Waschbeckenimitat EX252.00.000.

Die Waschbecken werden mit Befestigungssätzen geliefert. Es ist möglich, das Ausstellungsstück zu personalisieren, indem Sie aus den Produkten von Seite 41 auswählen.

The Ambience Mini Expo was designed to display:

- 1 wall-mounted washbasin;
- 2 wall-mounted accessories;
- 1 fake free-standing washbasin EX252.00.000.

The washbasins are supplied with a fixing kit. The display can be customised by choosing from the range of products on page 41.

Expo Mini Ambientación está diseñado para la exposición de:

- 1 grupo de lavabo de pared;
- 2 accesorios de pared;
- 1 falso lavabo independiente EX252.00.000.

Los lavabos se suministran con kit de fijación. Es posible personalizar el expositor eligiendo entre los productos de la pág. 41.

Expo Mini Ambientazione est conçu pour l'exposition de:

- 1 groupe lavabo fixé au mur;
- 2 accessoires fixés au mur;
- 1 faux lavabo freestanding EX252.00.000.

Les lavabos sont fournis avec le kit de fixation. Vous pouvez personnaliser le présentoir en faisant votre choix parmi les produits de la page 41.

Vista laterale:
Side view:
Vue latérale:
Seitenansicht:
Vista lateral:

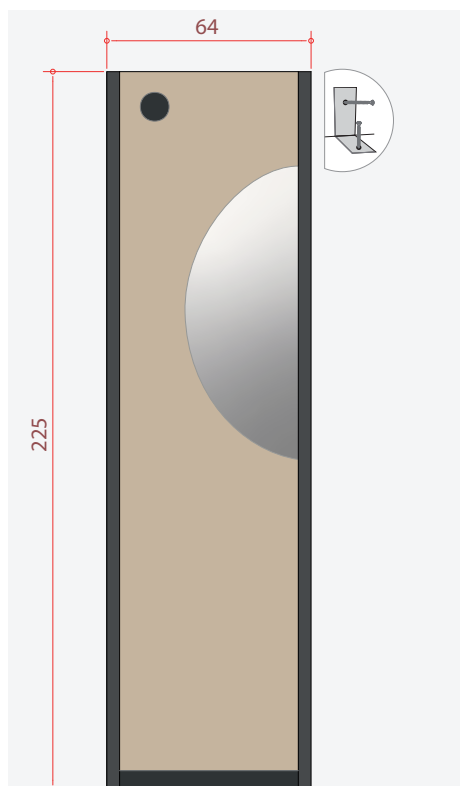

Vista in pianta:
Plan view:
Vue en plan:
Draufsicht:
Vista en planta:

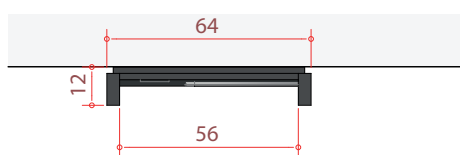

Centimetri - Centimetres
Centimètres - Zentimeter - Centímetros

EX252.00.000







LAVABO PARETE / WALL-MOUNTED WASHBASIN MIXER / LAVABOS MURAUX / WANDMONTAGE WASCHTISCHARMATUR / LAVABO DE PARED

completi di kit fissaggio / with fixing kit / doté d'un kit de fixation / Die Waschtisch Armaturen mit Montage Set geliefert / completo con kit de fijación

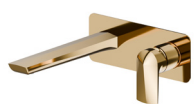

DELTA ZERO
72229E.61.020
€ 90,00



HAKA
72028E.59.097
€ 90,00



BLINK
70820E.47.083
€ 90,00



X-STEEL 316
69630EX.50.050
€ 60,00



X-WAY
73928E.01.093
€ 60,00

ACCESSORI / ACCESSORIES / ACCESSOIRES / ACCESSOIRES / ACCESORIOS

TONDI / ROUND / ROND / RUND / REDONDOS



● 67201.M0.075
€ 35,00



● 67205.M0.075
€ 40,00



● 67210.M0.075
€ 55,00



67227.M0.075
cm. 30
€ 65,00



67223.M0.075
€ 30,00



● 67215.M0.075
€ 60,00

QUADRI / SQUARE / CARRÉ / QUADRATISCH / CUADRADOS



● 62901.01.093
€ 35,00



● 62905.01.093
€ 40,00



● 62910.01.093
€ 55,00



62927.01.093
cm. 30
€ 65,00



62923.01.093
€ 30,00



● 62965.01.093
€ 60,00

X-STEEL



● 73201X.59.067
€ 81,00



73209X.59.064
€ 150,00



73204X.59.097
€ 100,00



73223X.59.067
€ 90,00



● 73215X.59.098
€ 124,00



EX252.00.000
€ 600,00

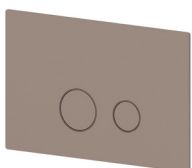

883.M0.075
€ 150,00

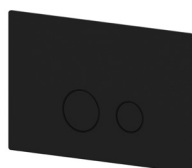

883.01.093
€ 150,00

● CERAMICA BIANCA / WHITE CERAMIC
CÉRAMIQUE BLACHE / WEIßE KERAMIK / CERÁMICA BLANCA
● CERAMICA NERA / BLACK CERAMIC
CÉRAMIQUE NOIRE / SCHWARZE KERAMIK / CERÁMICA NEGRA

EXPO **F** PANNELLO RETROILLUMINATO
 BACKLIGHT PANEL
 PANNEAU RÉTROÉCLAIRÉ
 HINTERGRUNDBELEUCHTETES PANEL
 PANEL RETROILUMINADO

Vista laterale:
 Side view:
 Vue latérale:
 Seitenansicht:
 Vista lateral:

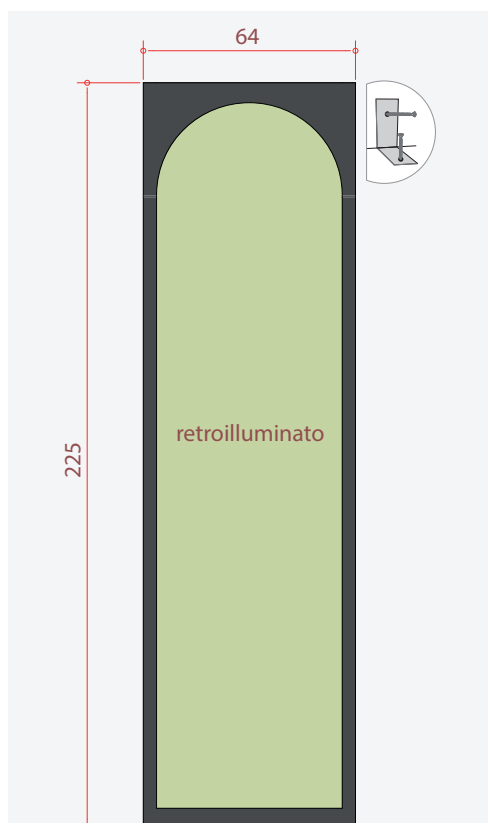

Vista in pianta:
 Plan view:
 Vue en plan:
 Draufsicht:
 Vista en planta:

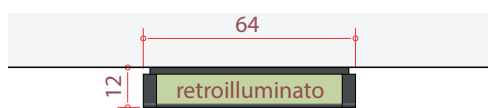

Centimetri - Centimetres
 Centimètres - Zentimeter - Centímetros



TERMINALE ALTO H. 28 cm.

HIGH TERMINAL / TERMINAL HAUT / HOHES TERMINAL / TERMINAL ALTO

EX245.00.000

L=32 cm

110,00 €

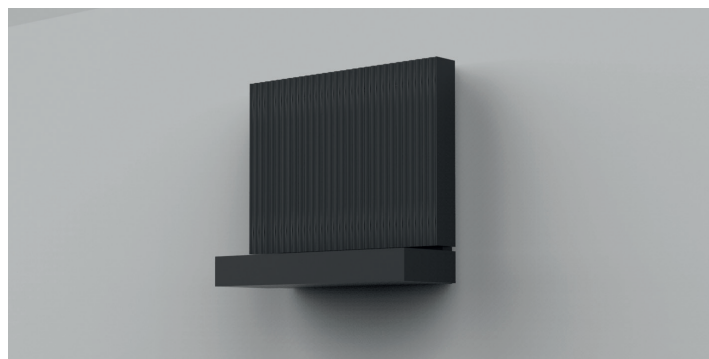

EX246.00.000

L=48 cm

125,00 €

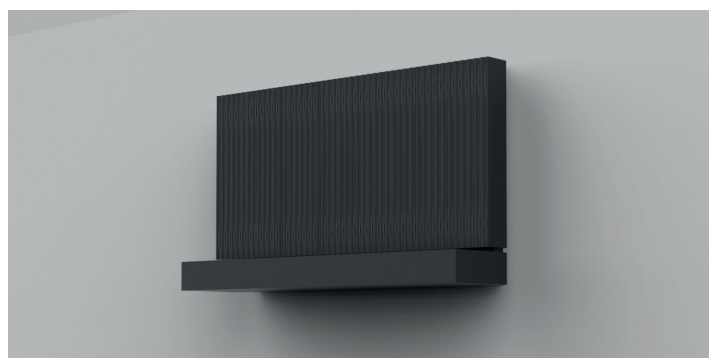

EX247.00.000

L=64 cm

150,00 €



EX248.00.000

L=96 cm

190,00 €



TERMINALE ALTO H. 28 cm. - CON LOGO

HIGH TERMINAL WITH LOGO / TERMINAL HAUT AVEC LOGO / HOHES TERMINAL MIT LOGO / TERMINAL ALTO CON LOGO

EX249.00.000

L=96 cm

350,00 €



newform



newform

newform

newform

newform

newform

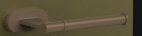
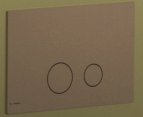
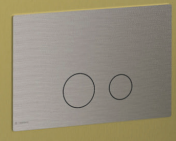
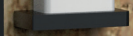
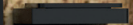

Gli strip led terminali alti sono solo illustrativi (non compresi).
 The high terminal led strips are for illustration only (not included).
 Les bandes LED terminales hautes sont uniquement illustratives (non comprises).
 Die LED Streifen des hohen Terminals sind nur illustrativ (nicht im Lieferumfang enthalten).
 Las tiras led terminales altas son solo ilustrativas (no incluidas).



newform

newform

newform

newform

newform

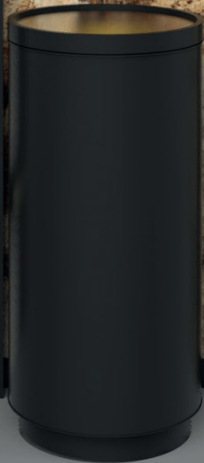
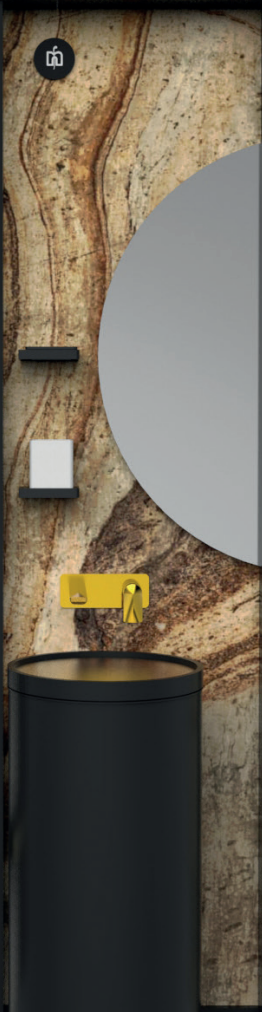
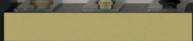

newform

newform

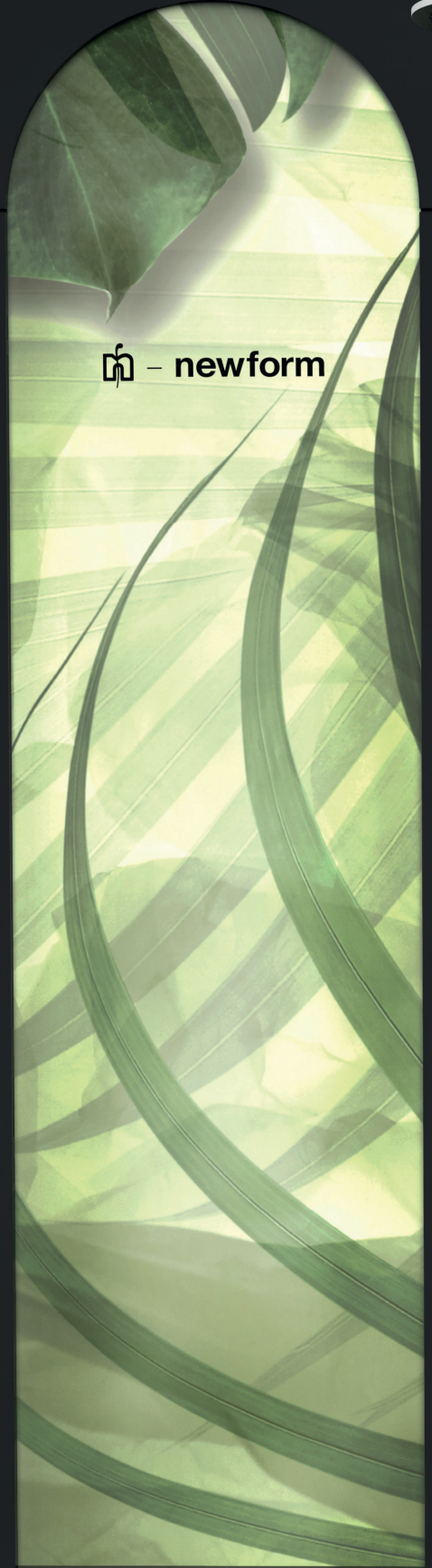

form

newform

newform

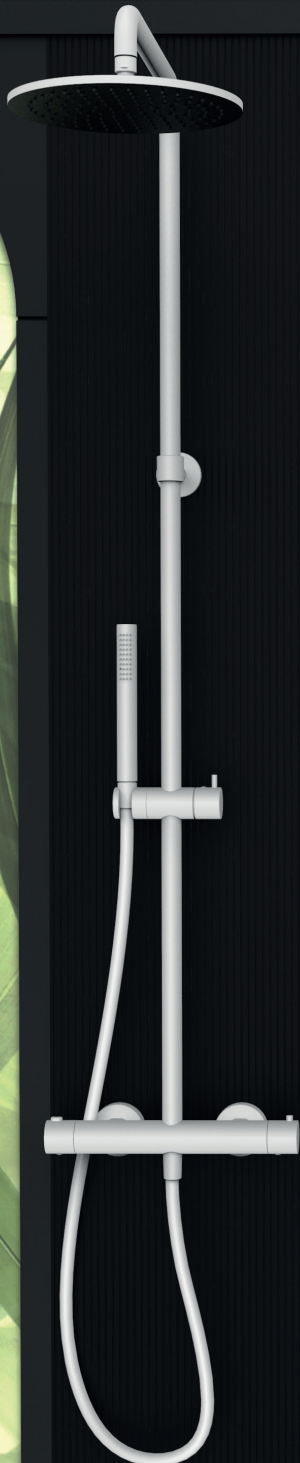

newform

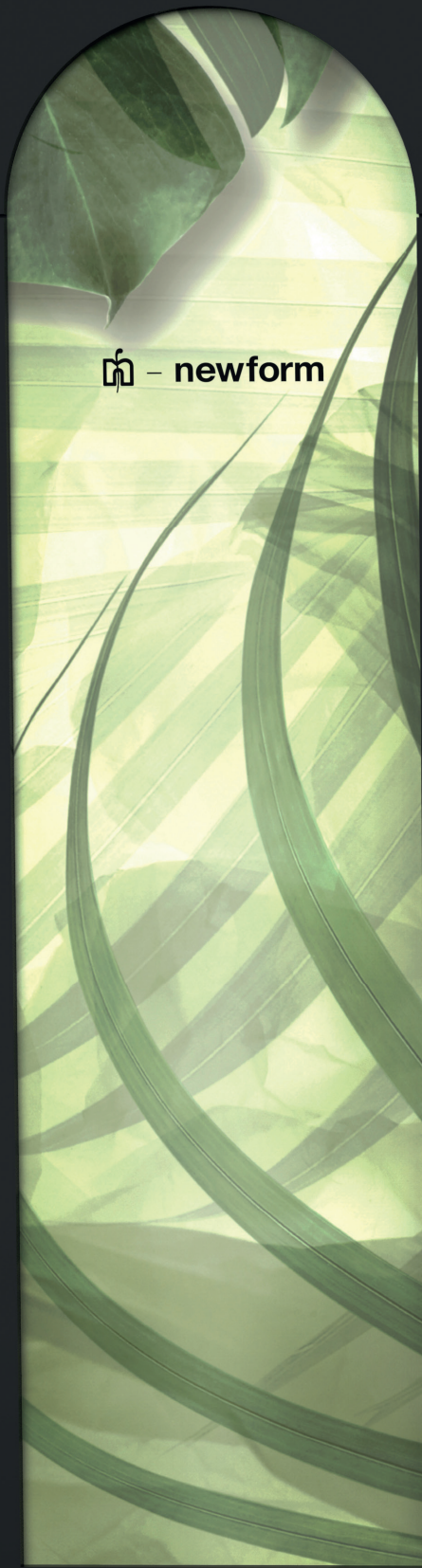

newform

newform

newform

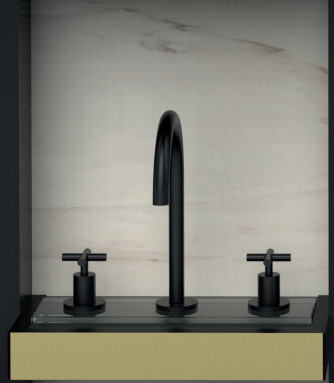
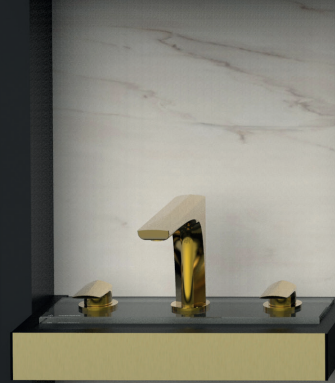



newform

newform

newform

DISPLAY SYSTEMS

IONIKA

EXPO SUPERIOR "IONIKA"

Expo Superior progettato per l'esposizione della collezione Ionika, comprensivo di:

- 3 miscelatori monoforo;
- 1 bocca per lavabo da piano;
- 1 comando remoto;
- 2 gruppi lavabo tre fori da appoggio;
- 1 lavabo tre fori a parete;
- 1 lavabo due fori a parete;
- 6 accessori;
- 1 kit doploncini finiture;

I lavabi vengono forniti su basetta e kit di fissaggio. È possibile personalizzare l'espositore scegliendo tra i prodotti di pag. 54.

Expo Superior, konzipiert für die Ausstellung der Ionika-Kollektion, darunter:

- 3 Einlochmischer;
- 1 Auslauf für Aufsatzwaschbecken;
- 1 Fernbedienung;
- 2 Aufsatz Dreiloch-Waschtischmischer;
- 1 wandmontiertes Dreiloch-Waschbecken;
- 1 wandmontiertes Zweiloch-Waschbecken;
- 6 Zubehörteile;
- 1 Satz Dublonen Oberflächenausführung;

Die Waschbecken werden auf einem Sockel und einem Befestigungssatz geliefert. Es ist möglich, das Ausstellungsstück zu personalisieren, indem Sie aus den Produkten von Seite 54 auswählen.

The Superior Expo was designed to display the Ionika collection, including:

- 3 single lever washbasin mixers;
- 1 opening for built-in washbasin;
- 1 remote control;
- 2 3-hole washbasin groups;
- 1 3-hole wall-mounted washbasin;
- 1 2-hole wall-mounted washbasin;
- 6 accessories;
- 1 small doubloons finishing kit;

The washbasins are supplied with a base and fixing kit. The display case can be customised by choosing from the products on page 54.

Expo superior diseñado para la exposición de la colección Ionika, que incluye:

- 3 mezcladores monomando;
- 1 caño para lavabo de encimera;
- 1 mando a distancia;
- 2 grupos de lavabo con tres orificios de apoyo;
- 1 lavabo de tres orificios en la pared;
- 1 lavabo con dos orificios en la pared;
- 6 accesorios;
- 1 kit doblones pequeños acabados;

Los lavabos se suministran sobre soporte y kit de fijación. Es posible personalizar el expositor eligiendo entre los productos de la pág. 54.

Expo Superior conçu pour l'exposition de la collection Ionika, qui comprend:

- 3 mitigeurs monotrou;
- 1 bouche pour lavabo à poser;
- 1 commande à distance;
- 2 groupes lavabo trois trous à poser;
- 1 lavabo trois trous fixé au mur;
- 1 lavabo deux trous fixé au mur;
- 6 accessoires;
- 1 kit doublons finitions;

Les lavabos sont fournis sur base et kit de fixation. Vous pouvez personnaliser le présentoir en faisant votre choix parmi les produits de la page 54.





IONIKA

IONIKA

design by Alessandra Bertini

 - newform



72812.59.066



72914.59.067



72815.59.098



72806.01.093



72901.61.020



73000.59.098



73020E.59.064



72830E.59.067



72805.01.093

ACCESSORI / ACCESSORIES / ACCESSOIRES / ACCESSOIRES / ACCESORIOS



73500.59.064



73506.59.064



73710.59.064



73528.59.064



73523.59.064



73522.59.064

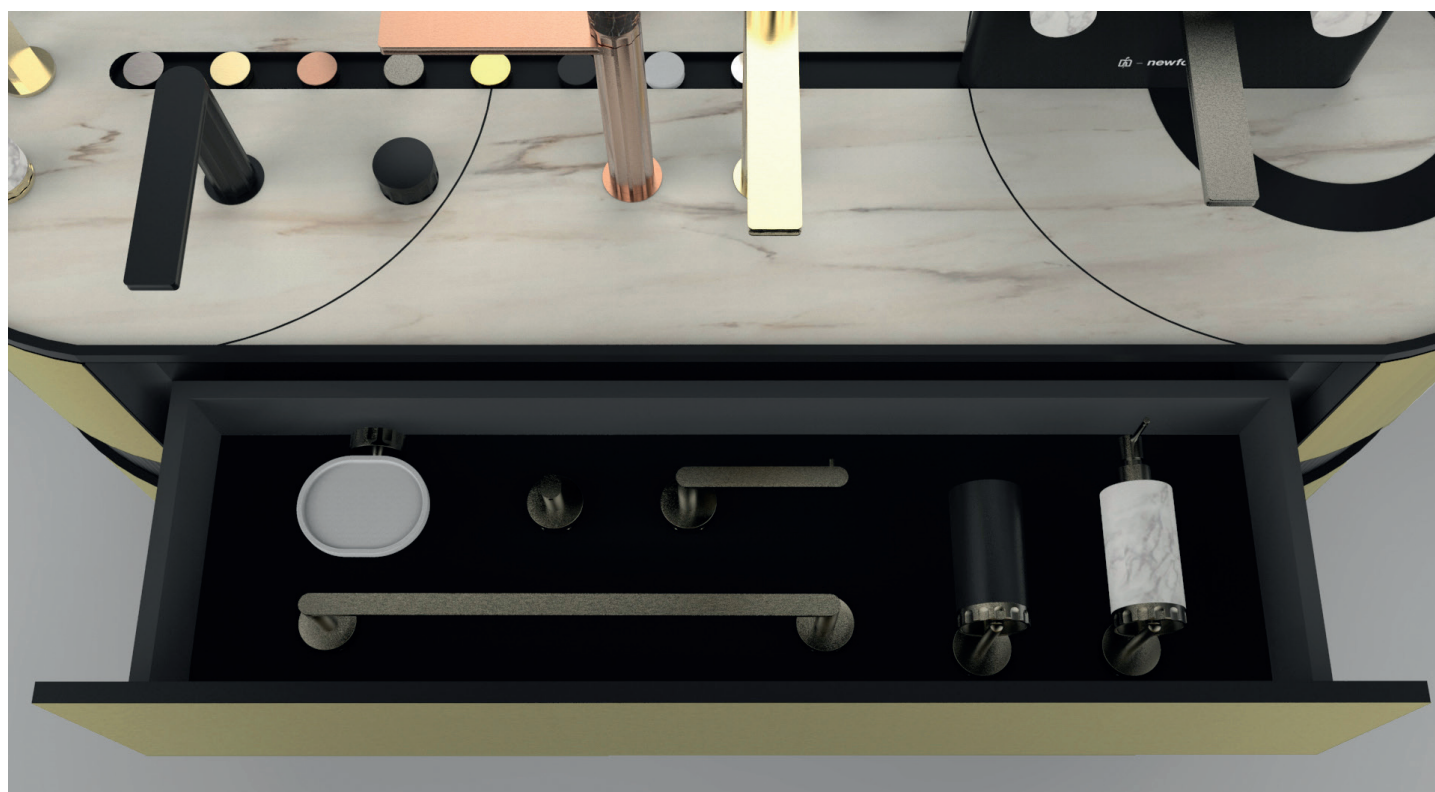

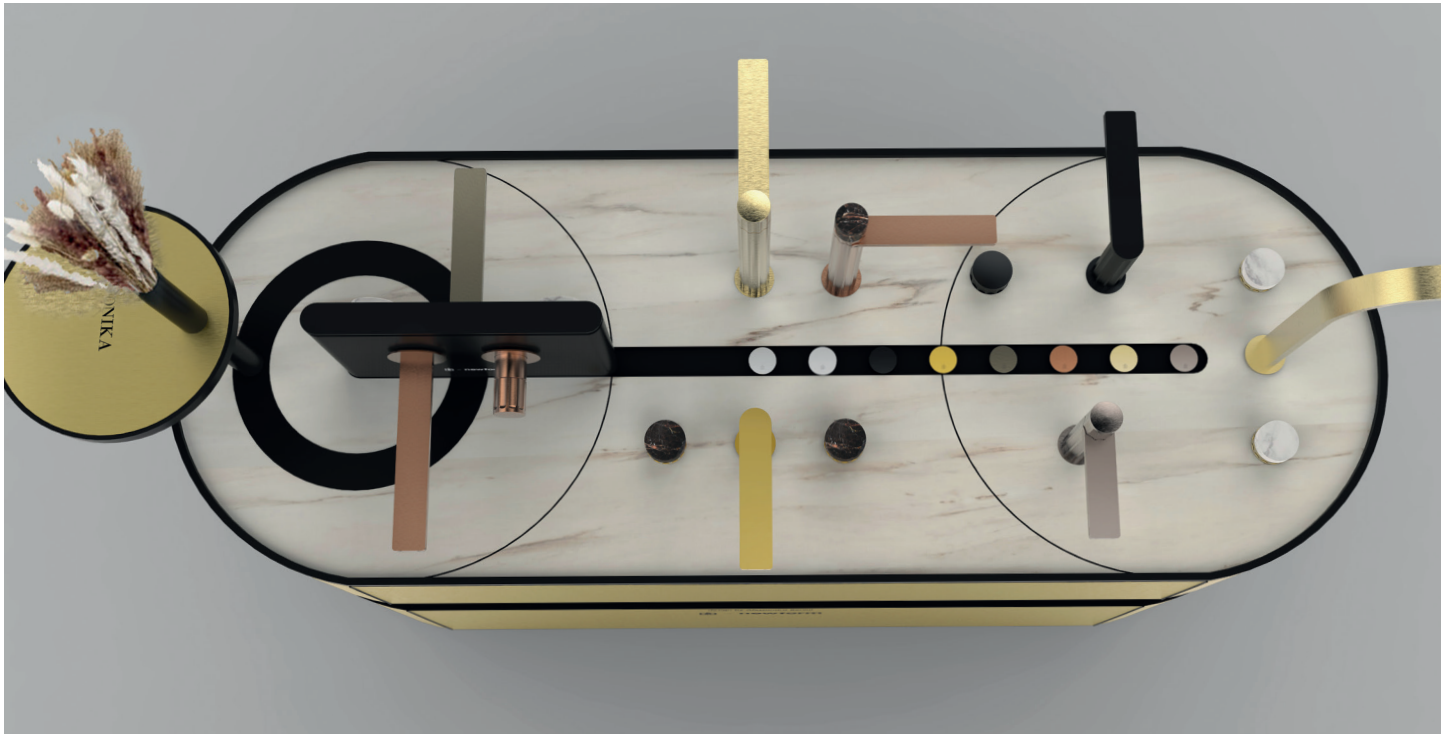

Vista laterale:
 Side view:
 Vue latérale:
 Seitenansicht:
 Vista lateral:

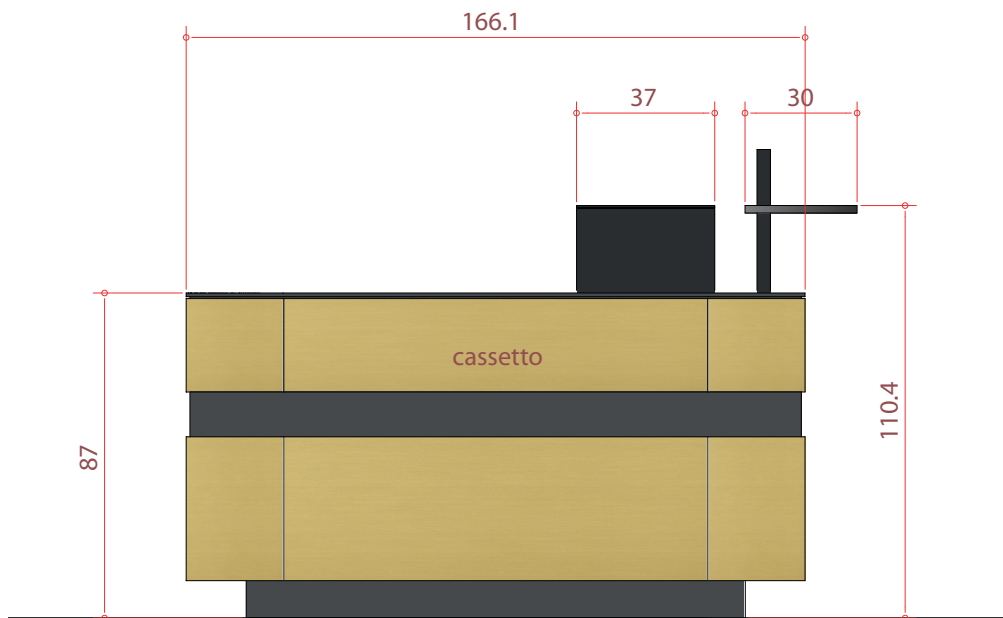

Vista in pianta:
 Plan view:
 Vue en plan:
 Draufsicht:
 Vista en planta:

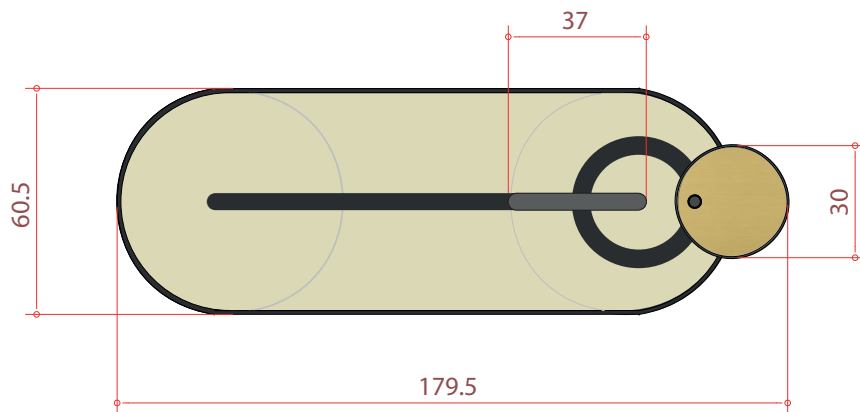

EX241.00.000

2.170,00 €

Completo di articoli - *Products included*
Expo complet avec des articles - *Display mit Produkte* - Completo con artículos

EXPO "IONIKA"

Expo C progettato per l'esposizione della collezione Ionika, comprensivo di:

- 2 miscelatori monoforo;
- 1 gruppo lavabo tre fori da appoggio;
- 1 rubinetto a parete;
- 1 kit dobloncini finiture;

I lavabi vengono forniti su basetta e kit di fissaggio.

Expo C was designed to display the Ionika collection, including:

- 2 single lever mixers;
- 1 3-hole counter top washbasin group;
- 1 wall-mounted tap;
- 1 doubloons finishing kit;

The washbasins are supplied with a base and fixing kit.

Expo C conçu pour l'exposition de la collection Ionika, qui comprend:

- 2 mitigeurs monotrou;
- 1 groupe lavabo trois trous à poser;
- 1 robinet mural;
- 1 kit doublons finitions;

Les lavabos sont fournis sur base et kit de fixation.

Die Expo C wurde für die Ausstellung der Ionika-Kollektion konzipiert und beinhaltet:

- 2 Einlochmischer;
- 1 Aufsatz Dreiloch-Waschtischmischer;
- 1 wandmontierter Wasserhahn;
- 1 Satz Dublonen Oberflächenausführung;

Die Waschbecken werden auf einem Sockel und einem Befestigungssatz geliefert.

Expo C diseñado para la exposición de la colección Ionika, que incluye:

- 2 mezcladores monomando;
- 1 grupo de lavabo con tres orificios de apoyo;
- 1 grifo de pared;
- 1 kit doblones pequeños acabados;

Los lavabos se suministran sobre soporte y kit de fijación.

Vista laterale:
Side view:
Vue latérale:
Seitenansicht:
Vista lateral:

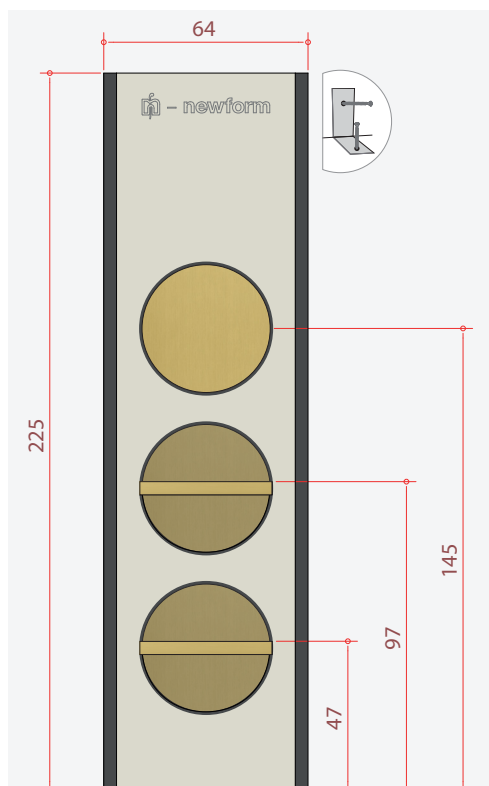

Vista in pianta:
Plan view:
Vue en plan:
Draufsicht:
Vista en planta:

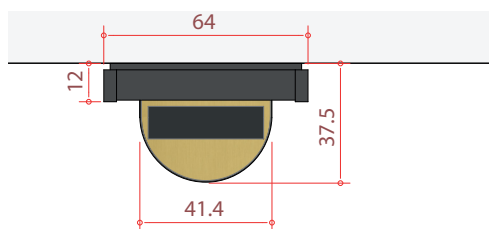

LAVABI / WASHBASINS
LAVABOS / WASCHBECKEN / LAVABOS

completi di basetta / on plexiglass base / dotés d'une base
Die Waschtisch Armaturen werden mit Sockel / dotados de soporte



72812DD.59.066



72914DD.59.067



72901DD.61.020



73020E.59.064

 - newform



IONIKA

design by Alessandra Bertini

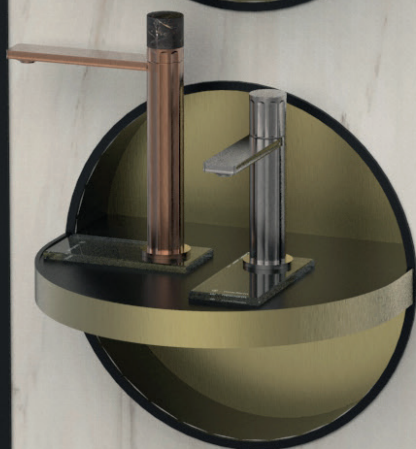
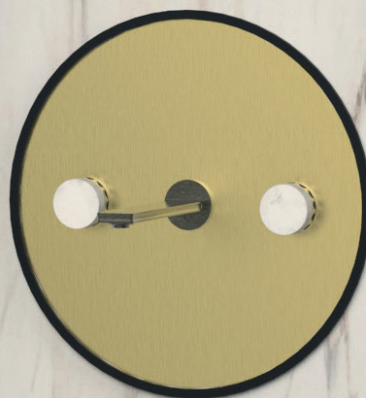

EX243.00.000

1.700,00 €

Completo di articoli - *Products included*
Expo complet avec des articles - *Display mit Produkte* - Completo con artículos

EXPO **E** WELLNESS "IONIKA"

Expo Wellness progettato per l'esposizione della collezione Ionika, comprensivo di:

The Wellness Expo was designed to display the Ionika collection, including:

Expo Wellness conçu pour l'exposition de la collection Ionika, qui comprend:

Expo Wellness wurde für die Ausstellung der Ionika-Kollektion entworfen und beinhaltet:

Expo Wellness diseñado para la exposición de la colección IONIKA, que incluye:

- 72859.59.067 Soffione tondo ø 300 mm BRUSHED COPPER BRONZE
Round head shower ø 300 mm BRUSHED COPPER BRONZE
Douche de tête ronde ø 300 mm BRUSHED COPPER BRONZE
Runder Duschkopf 300 mm BRUSHED COPPER BRONZE
Cabezal redondo ø 300 mm BRUSHED COPPER BRONZE
- 72848.59.067 Set doccia BRUSHED COPPER BRONZE
Shower set BRUSHED COPPER BRONZE
Kit douche BRUSHED COPPER BRONZE
Dusch-Set BRUSHED COPPER BRONZE
Juego de ducha BRUSHED COPPER BRONZE
- 567.59.067 Getti laterali snodati BRUSHED COPPER BRONZE
Articulated side jets BRUSHED COPPER BRONZE
Jets latérales articulés BRUSHED COPPER BRONZE
Seitliche Düsen BRUSHED COPPER BRONZE
Chorros laterales articulados BRUSHED COPPER BRONZE
- 73401.59.067 Parte esterna multiutenza BRUSHED COPPER BRONZE
Multi-use external part BRUSHED COPPER BRONZE
Partie externe multi-utilisateur BRUSHED COPPER BRONZE
Mehrbenutzer-Aussenteil BRUSHED COPPER BRONZE
Parte externa multiusuario BRUSHED COPPER BRONZE

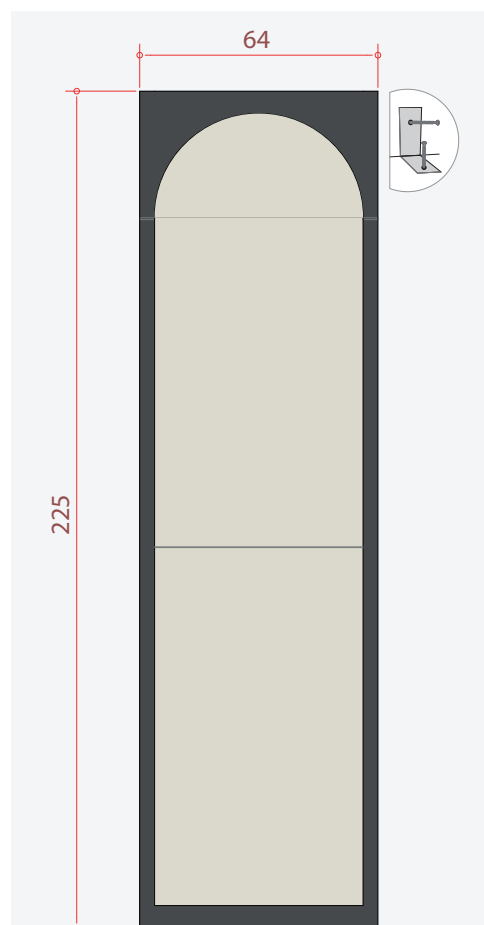

Vista laterale:
Side view:
Vue latérale:
Seitenansicht:
Vista lateral:

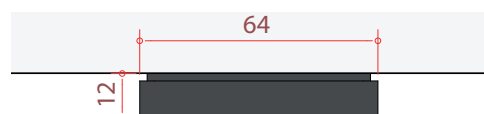

Vista in pianta:
Plan view:
Vue en plan:
Draufsicht:
Vista en planta:

Centimetri - *Centimetres*
Centimètres - *Zentimeter* - Centímetros

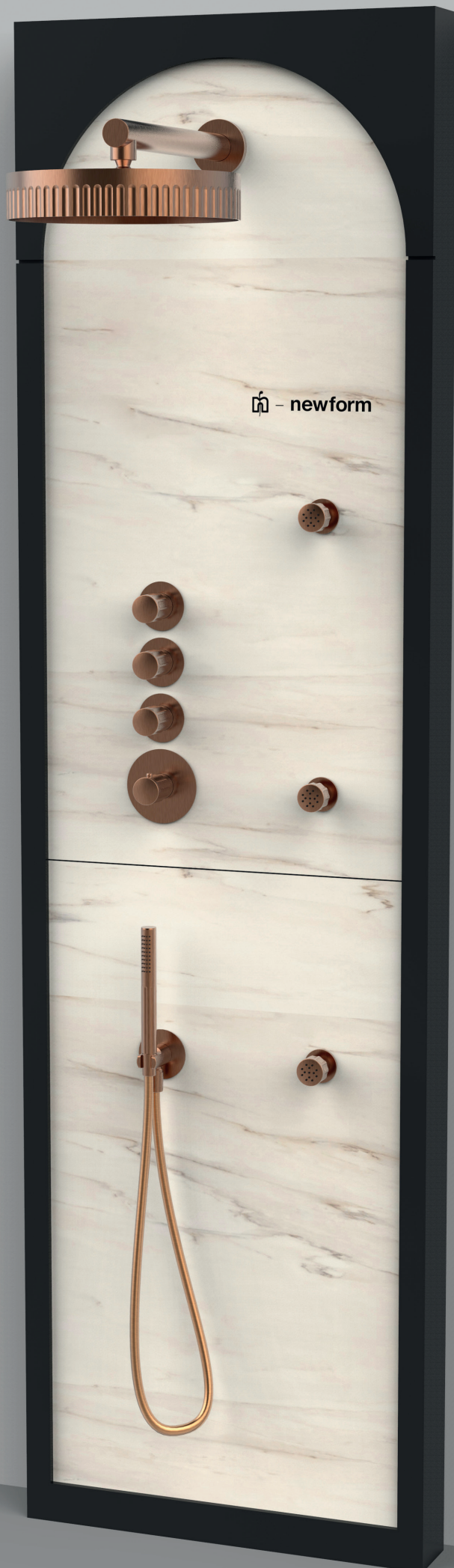

newform

EX238.00.000 BLACK

1.700,00 €

Completo di articoli - Products included
Expo complet avec des articles - Display mit Produkte - Completo con artículos

EXPO **E** COLONNA DOCCIA "IONIKA" / "IONIKA" SHOWER COLUMN
COLONNA DOCCIA "IONIKA" / "IONIKA" SHOWER COLUMN
COLUMNA DE DUCHA "IONIKA"

- 72850.59.098 Colonna doccia tonda termostatica PVD BRUSHED PALE GOLD
Round shower column with exposed thermostatic mixer
PVD BRUSHED PALE GOLD
Colonne douche ronde thermostatique PVD BRUSHED PALE GOLD
Runde thermostatische Duschsäule PVD BRUSHED PALE GOLD
Columna de ducha redonda termostática PVD BRUSHED PALE GOLD

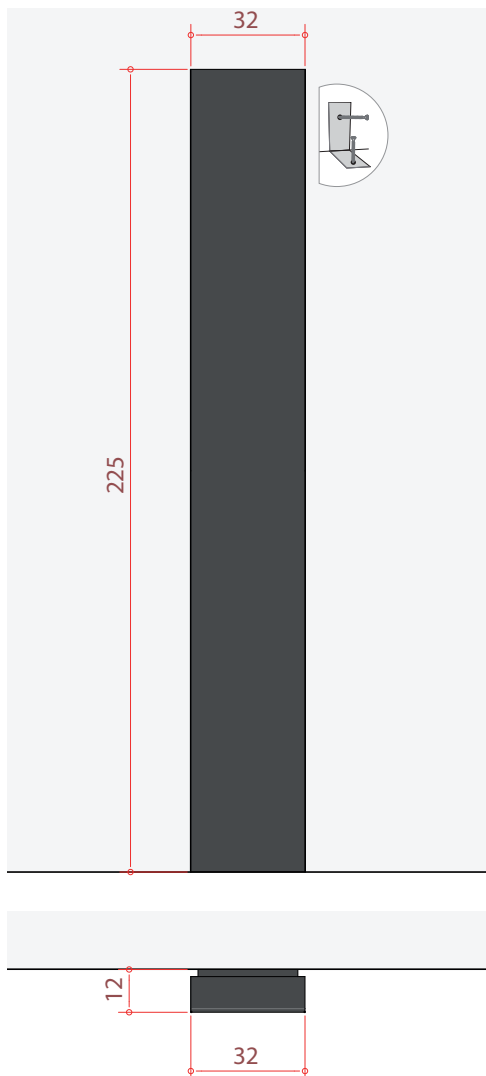

Vista laterale:
Side view:
Vue latérale:
Seitenansicht:
Vista lateral:

Vista in pianta:
Plan view:
Vue en plan:
Draufsicht:
Vista en planta:

Centimetri - Centimetres
Centimètres - Zentimeter - Centímetros



EX239.00.000 GOLD

1.150,00 €

Completo di articoli - Products included
Expo complet avec des articles - Display mit Produkte - Completo con artículos

EXPO **A2** ACCESSORI "IONIKA" / "IONIKA" ACCESSORIES / ACCESSOIRES "IONIKA"
"IONIKA" ACCESSOIRES / ACCESORIOS "IONIKA"

ACCESSORI



73710.59.064



73522.59.064



73523.59.064



73506.59.064

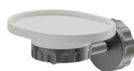

73500.59.064



73516.59.064

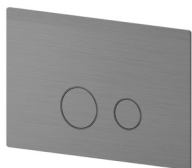

883.59.064



TERMINALE ALTO H. 28 cm.

HIGH TERMINAL / TERMINAL HAUT / HOHES TERMINAL / TERMINAL ALTO

EX245.00.000

L=32 cm

110,00 €

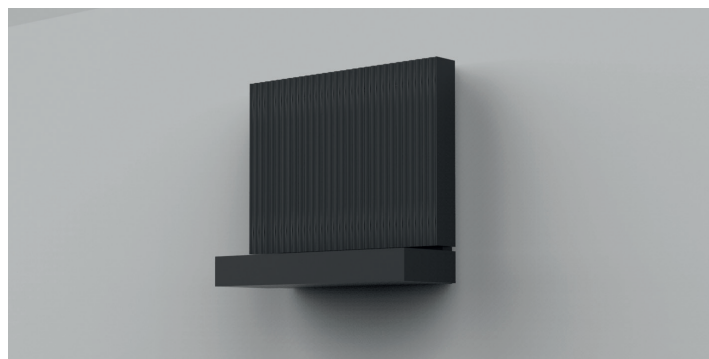

EX246.00.000

L=48 cm

125,00 €

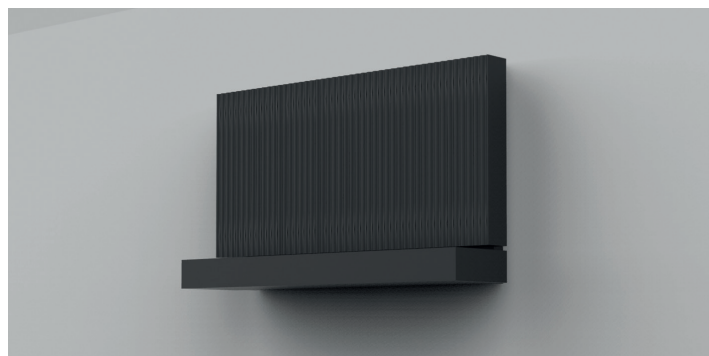

EX247.00.000

L=64 cm

150,00 €



EX248.00.000

L=96 cm

190,00 €



TERMINALE ALTO H. 28 cm. - CON LOGO

HIGH TERMINAL WITH LOGO / TERMINAL HAUT AVEC LOGO / HOHES TERMINAL MIT LOGO / TERMINAL ALTO CON LOGO

EX249.00.000

L=96 cm

350,00 €



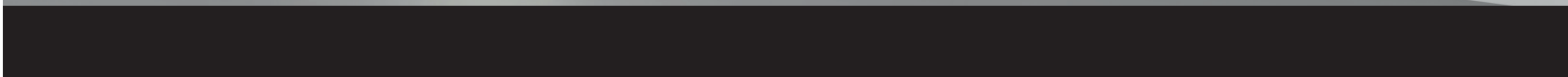

KITCHEN

EX236.00.000

580,00 €

Espositore vuoto - Empty display
Présentoir vide - Leerer Ausstellungsständer - Expositor vacío

EXPO KITCHEN

Expo kitchen è progettato per l'esposizione di:

- 3 miscelatori monoforo;
- 1 gruppo lavello tre fori;

I miscelatori vengono forniti su basetta e kit di fissaggio. È possibile personalizzare l'espositore scegliendo tra i prodotti di pag. 67.

Expo Küche ist für die Ausstellung von:

- 3 St. Küchen-Einhebelmischer;
- 1 St. 3-Loch Küchen Armatur;

Die Küchen Armaturen werden mit Sockel und Montage Set geliefert. Es ist möglich, das Ausstellungsstück zu personalisieren, indem Sie aus den Produkten von Seite 67 auswählen.

Expo kitchen is designed for the display of:

- 3 single lever basin mixers;
- one 3-hole sink group;

Basin mixers are supplied with plexiglass bases and wall-mounted mixers with proper fixing kits. The display case can be customised by choosing from the products on page 67.

Expo kitchen está diseñado para la exposición de:

- 3 mezcladores monomando;
- 1 grupo fregadero de tres orificios;

Los mezcladores se suministran sobre soporte y kit de fijación. Es posible personalizar el expositor eligiendo entre los productos de la pág. 67.

Expo kitchen conçu pour l'exposition de:

- 3 mitigeurs à seul trou;
- 1 groupe lavabo trois trous.

Les lavabos sont fournis avec une base et un kit de fixation. Vous pouvez personnaliser le présentoir en faisant votre choix parmi les produits de la page 67.



ESEMPIO DI CONFIGURAZIONE / SET-UP EXAMPLE / EXEMPLE DE CONFIGURATION / BEISPIELKONFIGURATION / EJEMPLO DE CONFIGURACIÓN

MISCELATORI / SINGLE LEVER MIXERS
 MITIGEURS / EINLOCHMISCHER / MEZCLADORES



72521DD.S0.165

€ 126,00



71823DD.M0.077

€ 120,00



71850DD.57.098

€ 232,00



4320DD.01.093

€ 90,00



63420DD.59.067

€ 105,00



63422XDD.50.050

€ 110,00



71731.59.064

€ 300,00

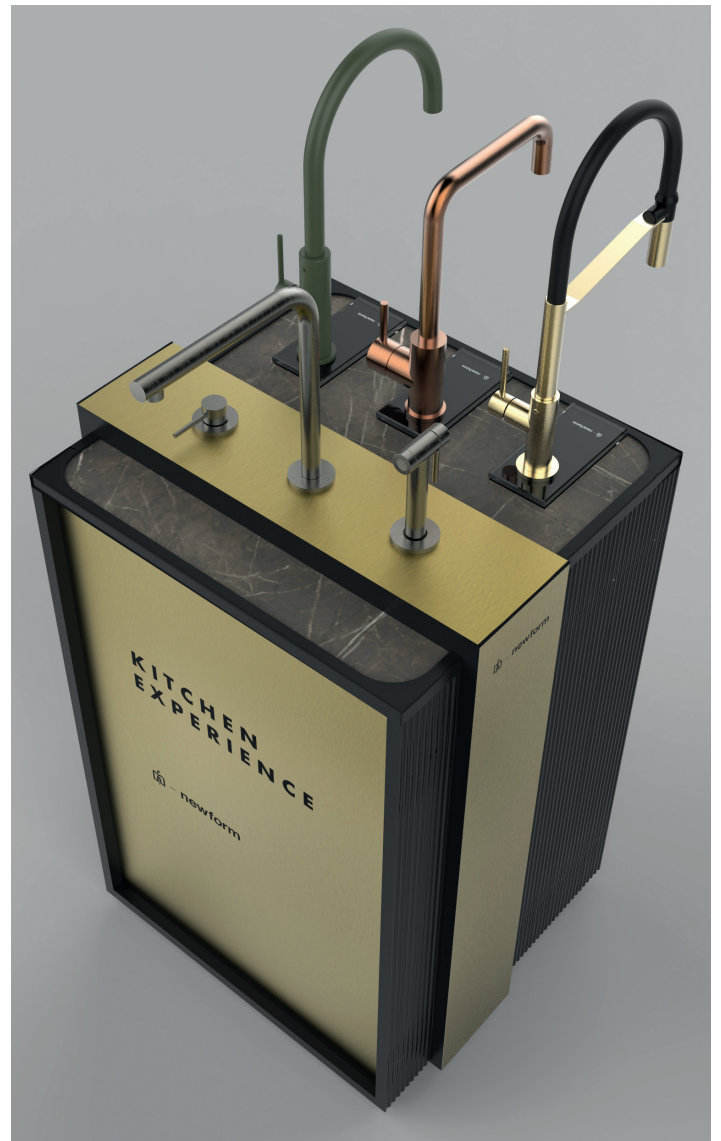

Vista laterale:

Side view:

Vue latérale:

Seitenansicht:

Vista lateral:

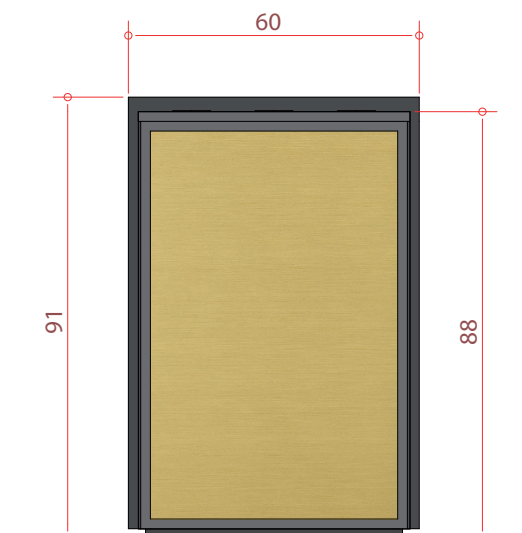

Vista in pianta:

Plan view:

Vue en plan:

Draufsicht:

Vista en planta:

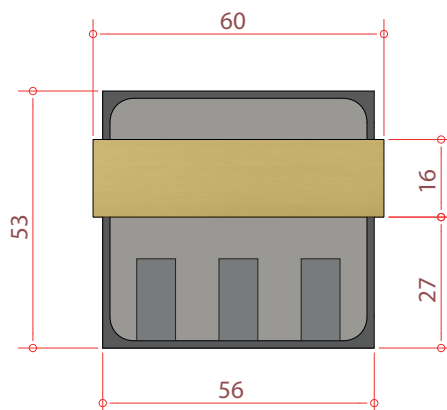

Centimetri - Centimetres
 Centimètres - Zentimeter
 Centímetros

FULL STYLE

RAC36.00.000

BOX CATALOGUE /PRICE LIST

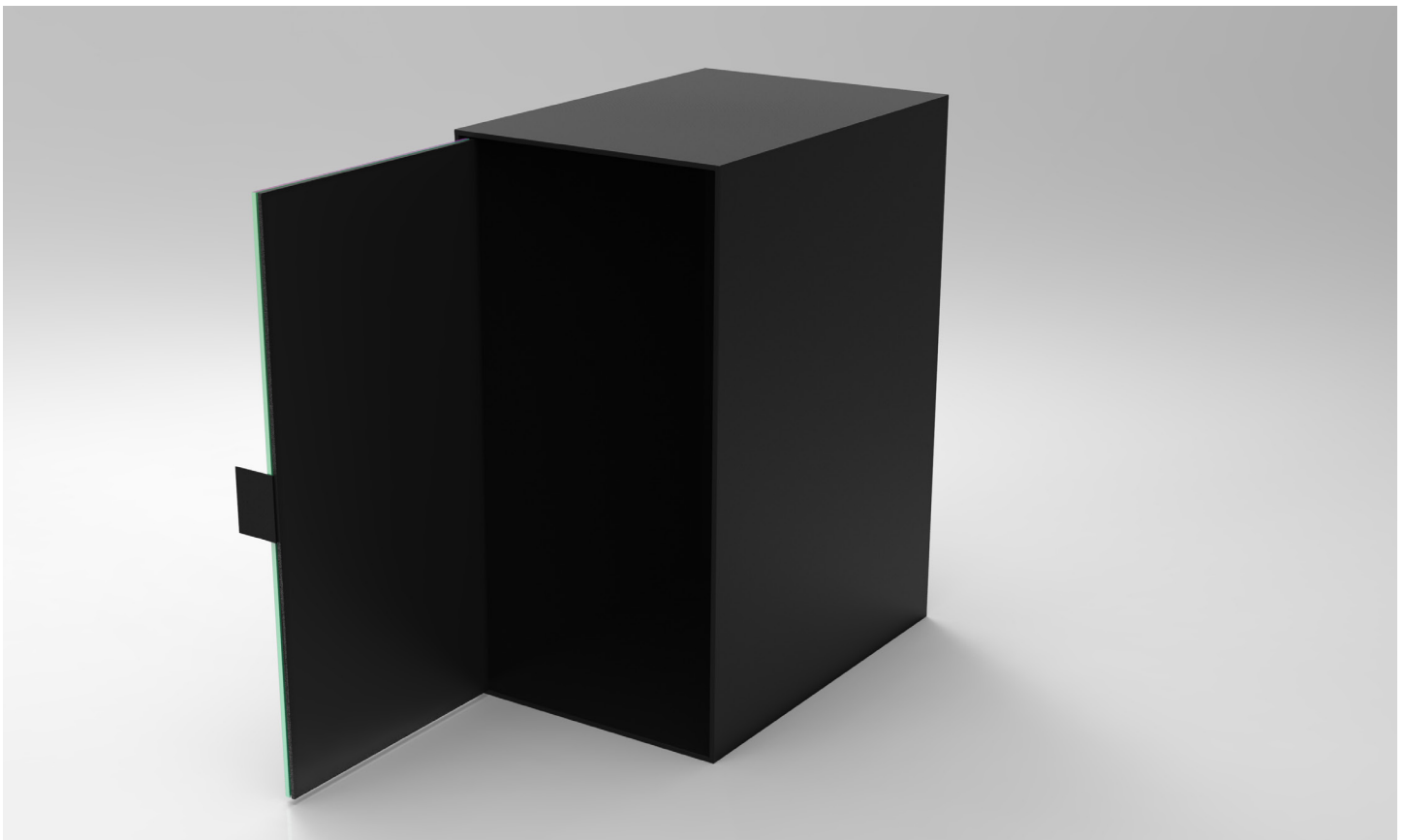

EX256.00.000

DESIRE TO INSPIRE



EX203.00.000

KITCHEN FINISHES



EX253.00.000

90,00 €
80x200 cm

ROLL-UP NEWFORM

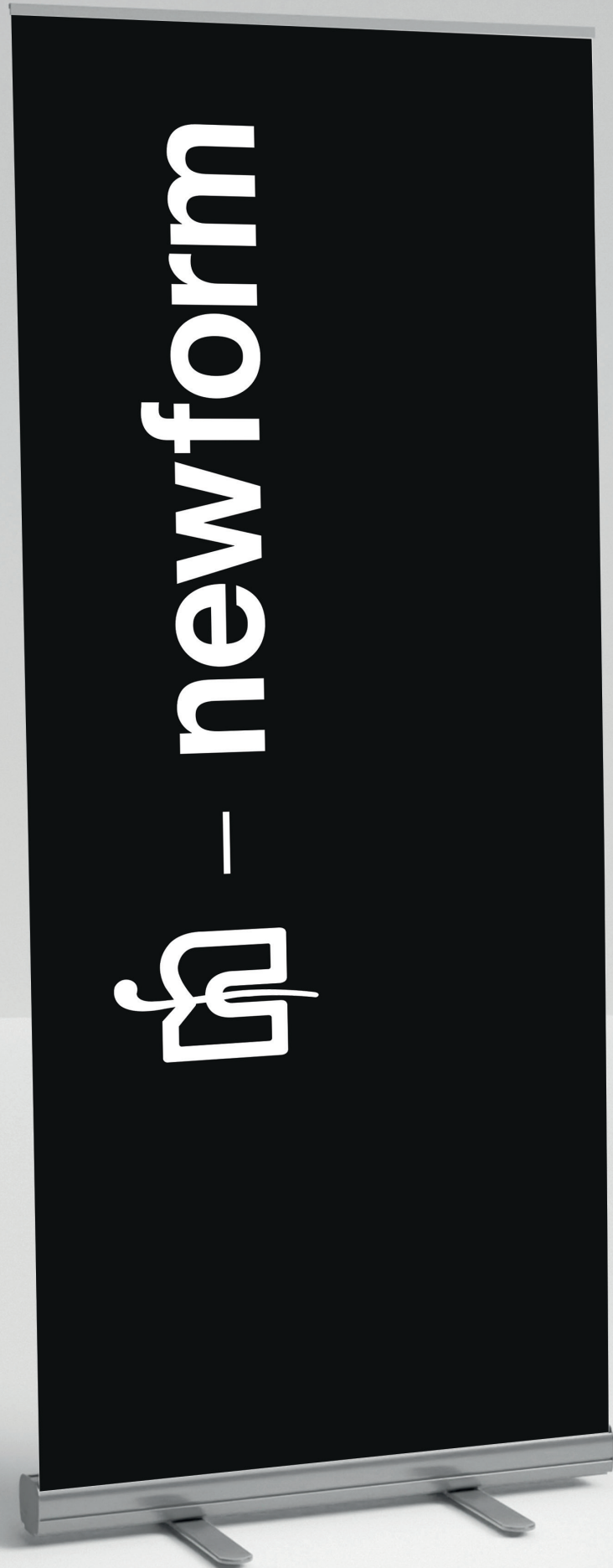

CONDIZIONI GENERALI DI VENDITA

1. Con la trasmissione dell'ordine il Cliente accetta tacitamente tutte le condizioni sottoesposte. Le vendite si intendono perfezionate solo dopo espressa approvazione della nostra azienda.
2. La merce è venduta al prezzo in vigore alla data della consegna. I termini di consegna si intendono approssimativi e quindi non impegnativi e non danno diritto alcuno a mancato pagamento o richiesta di risarcimento.
3. La merce viaggia a rischio e pericolo del committente anche se venduta a franco destino. La spedizione viene effettuata nel modo ritenuto più idoneo dalla ditta venditrice. All'atto della consegna il committente è tenuto alla verifica del materiale ordinato nonché al reclamo diretto al vettore in caso di manomissione o danneggiamento dell'imballo.
4. È fatta riserva assoluta di rendere del materiale senza nostra preventiva autorizzazione scritta.
5. Ogni reclamo e contestazione dovrà essere comunicato a mezzo lettera raccomandata entro e non oltre 5 giorni dalla data di ricevimento. In caso di reclamo effettuato in tempo utile, la merce dovrà esserci inviata franco nostro magazzino previo verifica dell'eventuale difetto. Nel caso di materiale riscontrato difettoso per cause a noi imputabili si provvederà alla sostituzione del prodotto restituito esclusa ogni ulteriore responsabilità della ditta venditrice per tutte le conseguenze dirette e indirette derivanti dalla installazione e dall'impiego.
6. In caso di ritardato pagamento verranno addebitati gli interessi commerciali a decorrere dal giorno successivo alla scadenza senza ausilio di diffide.
7. Le installazioni e le descrizioni contenute nei nostri stampati non comportano obbligo di fedele esecuzione, i dettagli e le misure contenute sono da considerarsi approssimative e soggette a modifiche senza preavviso.
8. In qualsiasi controversia la competenza esclusiva sarà del Foro di Vercelli.

Newform si riserva il diritto di apportare in qualunque momento, senza aggiornare tempestivamente questa pubblicazione, tutte quelle modifiche ai modelli, a scopo di miglioramento o per esigenze di carattere costruttivo.

Eventuali errori e/o refusi di stampa del presente listino non costituiscono motivo di contestazione.

RUBINETTERIA COLORATA

Per evitare errori o ritardi di spedizione, negli ordini specificare sempre il "numero di riferimento" corrispondente al colore prescelto sul n/s campionario colori.

Per colori e finiture NON DI SERIE, Newform si riserva di:

- Verificare la fattibilità.
- Comunicare eventuali costi aggiuntivi.
- Stabilire adeguati tempi di consegna.

PREZZI

Tutti i prezzi indicati si intendono in euro al netto di I.V.A. Il presente listino annulla e sostituisce tutti i precedenti.

GENERAL CONDITIONS OF SALE

1. *The buyer, by placing a purchase order, unconditionally accepts all the conditions below. Sales are considered confirmed only after the express approval of our company.*
2. *Products are sold at the price applicable at the date of delivery. Terms of delivery are approximative and not binding and will not entitle the Buyer to claim compensation for any damages or indemnities of any kind.*
3. *The goods travel at risk and expense of the Buyer even if Delivered Duty Paid. The selling company chooses the most suitable shipment method. The Buyer must check at the time of the delivery and detect any discrepancies related to the packaging, quantity, type and integrity of the Products with notification to the carrier.*
4. *It is not allowed to return products without our prior written authorization.*
5. *Any complaint and dispute must be communicated by registered letter within 5 days from the receipt. In the event of a complaint made in due time, Products must be immediately sent to our warehouse to allow the completion of the necessary tests. In case of defective products due to production problems, the defective product will be replaced, excluding any further liability for damages and/or defects of the Products deriving from anomalies caused by, or connected to, the installation by the Buyer or by the final consumer.*
6. *In case of late payment, interest rates will be charged starting from the day following the deadline without any notice.*
7. *The installations and descriptions in our documents do not imply an obligation of faithful execution, the details, and measures here are to be considered approximate and subject to change without notice.*
8. *Any dispute related to the Products supplied to the Buyer shall be decided by the Court of Vercelli.*

Newform reserves the right to modify all models for the purpose of improving them or for manufacturing needs, without prior notice to this publication and at any time.

Possible mistakes and/or misprints of current price list will not be object of dispute.

COLOURED ITEMS

In order to avoid mistakes or delays in shipping please always specify the reference number related to your choice based our colour table.

For DIFFERENT colours and finishings, Newform reserves the possibility:

- *To accept the order.*
- *To review the price.*
- *To adjust delivery time.*

PRICES

All prices do not include VAT. The present price list cancels and replaces all previous ones.

CONDITIONS GÉNÉRALES DE VENTE

1. Lors de la transmission de la commande, le Client accepte tacitement toutes les conditions énoncées ci-dessous. Les ventes ne sont pas considérées comme conclues qu'après l'accord exprès de notre société.
2. Les prix des marchandises vendues sont ceux en vigueur au jour de la date de livraison. Les conditions de livraison s'entendent approximatives et donc non contraignantes et ne donnent aucun droit au non-paiement ou à une demande d'indemnisation.
3. Le risque du transport est supporté en totalité par l'acheteur, même si les marchandises sont vendues « rendu droits acquittés ». L'expédition est effectuée de la manière jugée la plus appropriée par la société de vente. Lors de la livraison, le client est tenu de vérifier le matériel commandé ainsi que de déposer une réclamation directe auprès du transporteur en cas d'altération ou de détérioration de l'emballage.
4. Il est absolument interdit de retourner du matériel sans notre autorisation écrite préalable.
5. Toute réclamation et contestation doit être communiquée par courrier recommandé AR dans un délai maximal de 5 jours à compter de la date de réception. En cas de réclamation dans les délais impartis, la marchandise doit nous être envoyée pour qu'on puisse effectuer des tests. Dans le cas d'un produit jugé défectueux pour des raisons qui nous sont imputables, le produit retourné sera remplacé, excluant toute responsabilité supplémentaire de la société de vente pour toutes les conséquences directes et indirectes découlant de l'installation et de l'utilisation.
6. En cas de retard de paiement, les intérêts commerciaux seront facturés à compter du jour suivant la date limite sans l'aide d'avertissements.
7. Les installations et les descriptions dans nos documents n'impliquent pas d'obligation d'exécution fidèle, les détails et les mesures doivent être considérées comme approximatives et soumis à changement sans préavis.
8. Tout litige relatif à l'interprétation et à l'exécution des présentes conditions générales de vente est soumis au Tribunal de Vercelli.

Newform s'accorde le droit de modifier ses modèles à tout moment, sans mettre à jour immédiatement cette publication, à des fins d'amélioration ou de production.

Toute erreur et/ou fautes de frappe de ce tarif ne sont pas motif de réclamation.

ARTICLES COLORÉS

Afin d'éviter des erreurs d'expédition ou des retards, indiquez toujours le "numéro de référence" correspondant à la finition choisie sur nos documents.

Pour les finitions qui ne sont pas de série, Newform se réserve le droit de:

- Vérifier la faisabilité.
- Communiquer d'éventuels coûts supplémentaires.
- Définir de nouveaux délais de livraison.

PRIX

Tous les prix sont en euros et calculés hors taxes. Ces tarifs publics annulent et substituent les précédents.

ALLGEMEINE GESCHÄFTSBEDINGUNGEN FÜR DEN VERKAUF

1. Mit der Sendung der Bestellung akzeptiert der Kunde stillschweigend alle unten ausgeführten Bedingungen. Die Verkäufe sind erst dann abgeschlossen, wenn unser Unternehmen die Bestellung ausdrücklich angenommen hat.
2. Die Ware wird zum am Lieferdatum gültigen Preis verkauft. Die Lieferfristen sind nicht bindend und berechtigen nicht zur Zahlungsunterlassung oder Kostenrückerstattung.
3. Die Ware reist auf Risiko und Gefahr des Auftraggebers, auch wenn Sie frei Haus geliefert wird. Die Spedition erfolgt auf die nach dem Ermessen des Verkäuferunternehmens geeignetste Weise. Bei der Aushändigung der Ware ist der Auftraggeber verpflichtet, das bestellte Material zu prüfen und Manipulation oder Beschädigung der Verpackung direkt beim Frachtführer zu beanstanden.
4. Ohne unsere vorherige schriftliche Genehmigung darf auf keinen Fall das Material zurückgeschickt werden.
5. Jede Reklamation oder Beanstandung muss per Einschreiben innerhalb von 5 Tagen ab dem Erhalt der Ware mitgeteilt werden. Bei einer fristgerechten Reklamation muss die Ware frei Lager zurückgeschickt werden und wird auf den Mangel geprüft. Wenn das Material einen Mangel aufweist, der uns zugeschrieben werden kann, wird das zurückgeschickte Produkt unter Ausschluss jeder weiteren Haftung für alle direkten und indirekten Folgen durch die Installation und die Verwendung ausgetauscht.
6. Bei Zahlungsverzögerungen werden Verzugszinsen ab dem auf den Ablauf der Zahlungsfrist folgenden Tag berechnet, ohne dass es einer Abmahnung bedarf.
7. Die in unseren Druckerzeugnissen enthaltenen Installationen und Beschreibungen sind unverbindlich, die angegebenen Details und Maße sind als annähernd zu betrachten und können ohne Vorankündigung geändert werden.
8. Alle Rechtsstreitigkeiten werden ausschließlich vor dem Gericht Vercelli gebracht.

Newform behält sich das Recht vor, zu jedem Zeitpunkt ohne fristgemäße Aktualisierung dieser Publikation alle zur Verbesserung oder wegen bautechnischen Anforderungen notwendigen Änderungen an den Modellen vorzunehmen.
Etwaige Irrtümer und/oder Druckfehler in dieser Preisliste sind kein Grund zur Beanstandung.

FARBIGE ARMATUREN

Um Versandfehler oder -verzögerungen zu vermeiden, muss immer die „Referenznummer“ für die gewählte Farbe auf unseren Farbmustern angegeben werden.

Für Farben und Oberflächen, die NICHT STANDARD sind, behält sich Newform das Recht vor:

- Überprüfung der Machbarkeit.
- Informieren über eventuelle weitere Kosten.
- Festlegung der Lieferzeiten.

PREISE

Alle Preise sind in Euro und ohne Mehrwertsteuer. Diese Preisliste annulliert und ersetzt alle vorherigen Preislisten.

CONDICIONES GENERALES DE VENTA

1. Con la transmisión del pedido, el Cliente acepta tácitamente todas las condiciones expuestas a continuación. Las ventas se consideran perfeccionadas solo después de la aprobación expresa de nuestra empresa.
2. La mercancía se vende al precio vigente en la fecha de entrega. Los plazos de entrega son aproximados y, por lo tanto, no vinculantes y no dan derecho a ningún tipo de falta de pago o solicitud de indemnización.
3. La mercancía viaja por cuenta y riesgo del cliente, incluso si se vende con entrega en el destino. El envío se realiza de la manera que la empresa vendedora considere más adecuada. En el momento de la entrega, el cliente está obligado a verificar el material solicitado, así como a reclamar directamente al transportista en caso de manipulación o daño del embalaje.
4. Está absolutamente reservado el derecho de devolver material sin nuestra autorización previa por escrito.
5. Todas las quejas y reclamaciones deberán comunicarse por carta certificada en un plazo máximo de 5 días a partir de la fecha de recepción. En caso de reclamación efectuada a su debido tiempo, la mercancía deberá ser enviada franco nuestro almacén previa comprobación del eventual defecto. En el caso de material encontrado defectuoso por causas imputables a nosotros, se procederá a la sustitución del producto devuelto, excluyendo cualquier responsabilidad adicional de la empresa vendedora por todas las consecuencias directas e indirectas derivadas de la instalación y el uso.
6. En caso de retraso en el pago, se cobrarán los intereses comerciales a partir del día siguiente al vencimiento sin la mediación de avisos.
7. Las instalaciones y las descripciones contenidas en nuestro material impreso no implican obligación de fiel ejecución, los detalles y las medidas contenidas son aproximadas y están sujetas a cambios sin previo aviso.
8. Ante cualquier controversia, la competencia exclusiva será del Tribunal de Vercelli.

Newform se reserva el derecho de realizar en cualquier momento, sin actualizar oportunamente esta publicación, todas las modificaciones de los modelos que considere con fines de mejora o por necesidades de fabricación.

Los eventuales errores y/o erratas de impresión de este catálogo no constituyen motivo de reclamación.

GRIFERÍA DE COLOR

Para evitar errores o retrasos en el envío, en los pedidos especifique siempre el "número de referencia" correspondiente al color elegido de nuestro muestrario de colores.

Para colores y acabados NO ESTÁNDAR, Newform se reserva el derecho de:

- Comprobar su viabilidad.
- Comunicar cualquier coste adicional.
- Establecer plazos de entrega adecuados.

PRECIOS

Todos los precios indicados se entienden en euros sin IVA. Este catálogo anula y sustituye a todos los anteriores.



www.newform.it
newform@newform.it

NEWFORM S.p.A.
via Marconi, 25/A
Frazione Vintebbio
13037 Serravalle Sesia (VC) Italy
Phone: +39 0163 452011 (r.a.)

Direzione Creativa / Creative Direction
Direction créative / Kreative Richtung / Dirección Creativa
Newform S.p.A.

I colori rappresentati nelle immagini sono puramente indicativi.

L'azienda si riserva in qualunque momento di apportare senza preavviso modifiche a prodotti e accessori.

Eventuali errori e/o refusi di stampa del presente listino non costituiscono motivo di contestazione.

The colours shown are just an indication.

The Manufacturer reserves the right to modify products and accessories at any time without prior notice.

Possible mistakes and/or misprints of current price list will not be object of dispute.

Les couleurs des images présentées sont à considérer purement indicatives.

La société se réserve le droit d'apporter toute modification aux articles et accessoires à tout moment et sans préavis.

Toute erreur et/ou fautes de frappe de ce tarif ne sont pas motif de réclamation.

Die in den Bildern gezeigten Farben sind nur Richtwerte.

Das Unternehmen behält sich das Recht vor, jederzeit ohne Vorankündigung Änderungen an Produkten und Zubehör vorzunehmen.

Etwaige Irrtümer und/oder Druckfehler in dieser Preisliste sind kein Grund zur Beanstandung.

Los colores representados en las imágenes son meramente indicativos.

La empresa se reserva el derecho en cualquier momento de realizar cambios en los productos y accesorios sin previo aviso.

Los eventuales errores y/o erratas de impresión de este catálogo no constituyen motivo de reclamación.



newform.it