

price list  
january 2025

2025

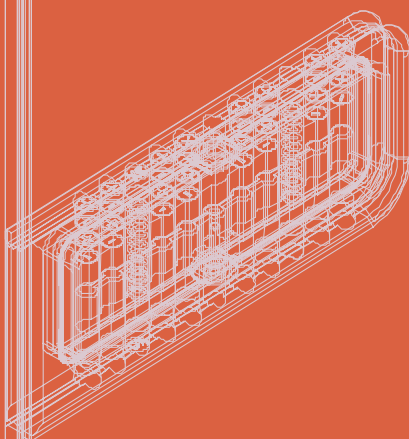
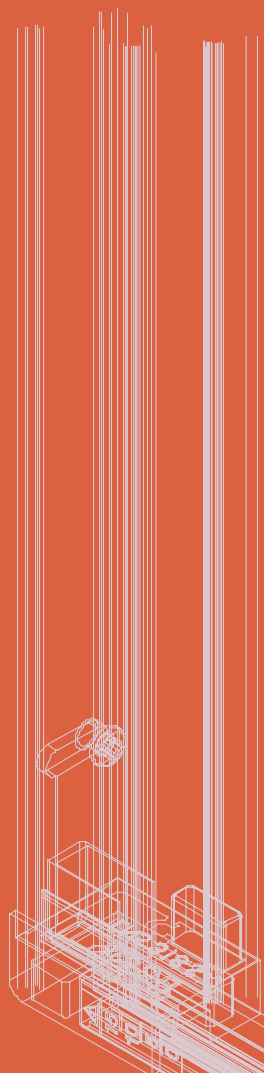

vismara  
vetro

# finishing

## PROFILES

- 05 Red
- 07 Yellow
- 09 Matt black
- 10 Pergamon
- 11 Grey
- 12 Green
- 13 Light blue
- 14 White
- 15 Matt white
- 21 Bright silver
- 23 Bright gold
- 31 Satin silver
- 32 Satin bronze
- 33 Satin gold
- 34 Matt copper
- 35 Matt gold
- 38 Moka
- 39 Metal gun
- 52 Brushed bronze
- 54 Brushed copper
- 61 Brushed steel finishing
- 73 Dark bronze
- 84 Bond copper

## GLASSES

- 01 Obscure
- 03 Clear bronze
- 04 Transparent
- 05 Timeless®
- 06 Reflecting
- 07 Clear grey
- 08 Satin
- 10 Extra-reflex
- 11 Kathedral
- 12 Extra-light
- 14 Extra-light satin
- 24 Reeded 6 mm
- 29 Madras Nuvola
- 34 Securplus™ reeded
- 37 Securplus™ grey reeded
- 44 Securplus™ transparent
- 51 Securplus™ silver net
- 53 Securplus™ bronze net

# index

general information	extended warranty	003	profiles' finishes	006/007	decors	012/013
	glass treatments	004	laminated glass	009	personal glass	014/015
	SMF	005	tempered glass	010/011		
<b>COLLECTIONS LUXE</b>						
frame	PKT	024/025	PKB	028/029		
	PKF	026/027	PKS	030/031		
link	KN	036/037	KM	044/045	KC - KG	052/053
	KB	038/039	K3	046/047	KP	054/055
	K2	040/041	KA	048/049		
	KZ	042/043	KF	050/051		
supersintesi	XN	060/061	XA	064/065	XG	068/069
	XM	062/063	XF	066/067	XP	070/071
flare 2.0	FN	076/077	FA	080/081	FG	084/085
	F2	078/079	FF	082/083		
serie F	HL	092/093	H2	096/097		
	HN	094/095				
gliss	DN	102/103	DQ	108/109	DG	114/115
	D3	104/105	DF	110/111	DP	116/117
	D4	106/107	DA	112/113		
<b>COLLECTIONS ICONS</b>						
sk-in	SK	126/127	SB	132/133	S2	136/137
	CK	128/129	SZ	134/135		
	SJ	130/131	SY	134/135		
linea	LN	142/143	LM	150/151	LG	158/159
	LB	144/145	L3	152/153	LP	160/161
	L2	146/147	LA	154/155	LT - LTX	162/163
	LZ	148/149	LF	156/157		
twin	T1	166/167	T3	170/171		
	T2	168/169	T4	172/173		
sintesi	SL	182/183	SF	190/191	ST - SH	198/199
	SN	184/185	SG	192/193	SX -SD	200/201
	SM	186/187	SP	194/195		
	SA	188/189	TRS	196/197		
replay	RN	206/207	RA	210/211	RG	214/215
	RM	208/209	RF	212/213	RV	216/217
serie 8000	CN	222/223	C4	228/229	CA	234/235
	CL	224/225	CQ	230/231	CG	236/237
	C3	226/227	CF	232/233	CP	238/239
<b>COLLECTIONS ESSENCE</b>						
smack	MK	248/249	M2	254/255	MG	260/261
	MN	250/251	MA	256/257	MP	262/263
	MB	252/253	MF	258/259		
junior	GN	268/269	GA	272/273	GF	276/277
	GM	270/271	G2	274/275	GP	278/279
serie 7200	ZN	284/285	ZA	290/291	ZT	294/295
	ZQ	286/287	ZG	292/293	ZD	294/295
	ZF	288/289				
<b>OTHER SOLUTIONS</b>						
bathscreens	VR	300/301	SV	308/309	HV	314/315
	SR	302/303	SE - SI	310/311	BN	316/317
	PV	304/305	FB	310/311	B4	316/317
	NP	306/307	LV	312/313		
radiante	technical info	318/319				
	models	320/321				
complements	virgola	323	columns amico	328	profiles	333
	cleaning	323	columns basket	329	seals	334/336
	shower trays Vi.P	324/325	brackets	330	spare parts	337
	towel holders	326	rods	331	installations	338/339
	screen	327	special fittings	332	layouts for measures	340/343

Vismaravetro is leader in the market of shower enclosures made of tempered glass.

Standard and customized products are 'totally made in Italy' according to high production quality standards and innovative technologies.

Vismaravetro operates in two production sites (Giussano and Verano Brianza/Monza Brianza) counting a total surface area of 32,000 square meters.

Today Vismaravetro is characterised by a powerful international calling. Products are distributed in 25 foreign nations through a network that counts 2,100 points of sale.

We operate in France through the network of VismaraFrance and in Belgium with VismaraBelgio. We also have a sales office in Spain.

In downtown Milan, Vismaravetro is co-founder of H2Otto, an area devoted to designers, architects, general contractors and construction companies. H2Otto is not just a simple showroom, instead, it's a multi-purpose facility for consulting services, training and innovative know-how on the products on display.



Giussano



Verano Brianza

Vismaravetro H2Otto - Milano (I)



Vismara France - Roissy (F)



Vismara España - Barcelona (E)



Vismara Belgio - Aalst (B)

**Vismaravetro srl**  
Registered office  
20843 Verano B. (MB) Italy  
via Furlanelli, 29

**Shower enclosure division**  
20843 Verano B. (MB) Italy  
via Furlanelli, 29  
telephone +39 0362 992244  
e-mail: info@vismaravetro.it  
www.vismaravetro.it

**Showroom H2Otto**  
20123 Milano (MI) Italy  
via Crocefisso, 27  
e-mail: info@h2otto.it  
www.h2otto.it

## the certified quality

### EN 14428:2018

Vismaravetro shower enclosures are manufactured in conformity with European standards.



### Certification of door opening cycles

Vismaravetro shower enclosures have to pass 50.000 opening and closing cycles, which is more than the standard requirement.

### Glass certification EN 12150 / 1863

Vismaravetro is certified for the thermal treatment of the glass (thermal hardening). These certifications authorize Vismaravetro to use the UNI mark, which authenticates that products undergo rigorous resistance and safety checks. These are not "self-certifications", but external tests carried out by an independent certification board, same as CSICERT, belonging to the IMQ Group.

### Environmental management system ISO 14001

Since February 2004 Vismaravetro has been certificated ISO 14001. This standard certifies that Vismaravetro's "company system" operates in compliance with laws that protect the environment. From production processes to materials used, from emissions into the atmosphere to company building structures, from water discharge to waste management... everything is carefully organized to cause the least environmental impact.

### ISO 9001

Quality management system certification of manufacturing process.

### EPD Certification Eco-friendly shower enclosures

The EPD is a voluntary certified declaration, which provides specific data on the environmental impact of the product, in accordance with the international standard ISO 14025 and EN 15804.

Vismaravetro has always had a "green" focus on its production. Starting from the materials used, glass and aluminum, which by their nature are entirely recyclable thanks to modern recovery and recycling systems. Over the years, Vismaravetro's attention has also been directed towards a simplification and efficiency of production standards. In fact, when the company engineers a project, it considers the correct use of materials, technologies and processes to make its own contribution in the direction of eco-sustainability. In the company, everything is carefully organized to minimize the impact on the environment: from the production processes to the materials used, from emissions into the atmosphere to company building structures, from water discharges to waste management.

## warranty

Free extension of the warranty to 5 years through online registration



Italian and international standards guarantee all products for 24 months from the date of purchase. To give you an exclusive service, Vismaravetro extends free the warranty for 3 additional years. In this way, the glasses of your shower enclosure and bathscreens are guaranteed to 5 years from the date of purchase

**In order to obtain the 5 year extended warranty, the consumer must register on the website :**

[www.vismaravetro.it/warranty](http://www.vismaravetro.it/warranty)

The warranty is extended to 5 years commencing from the purchase/delivery date of the product to the Consumer, relating only to breakages of glass panels.

The warranty on glass includes:

a) The replacement of the broken glass, including any metal parts bonded to the same and/or any seals applied.

The extended warranty excludes:

- a) Assembly of the replaced part.
- b) The restoration of any other element of the shower enclosure.
- c) Any damage caused by the breakage of glass to other elements (shower tray, bathtub, bathroom furniture, floors, walls, tiles, doors, windows, bathroom accessories, lighting systems, etc.)
- d) Breakages during transportation.
- e) Breakages due to manual handling of the shower enclosure and breakages occurring during installation of the same, during the initial installation phase or upon subsequent repositioning.
- f) Breakages occurring during normal use of the shower enclosure and due to knocks suffered by the glass against items of bathroom furniture (bathroom suites, toilet bowls, taps, towel rails, ...) or against architectural elements (walls, small walls, doors, scope ceilings etc.).



# Glass Treatments: TPA-TIMELESS®

Vismaravetro has always been very focused on technologies that can help its customers maintain a clean shower enclosure. We have now selected two innovative solutions: a nanotechnology treatment to prevent limescale from adhering to the glass and a glass with an anti-oxidising surface to maintain the transparency and shine of the glass over time.



## TPA- Preventive treatment against limescale deposits

The glass surface is treated with a nanotechnology which limits the adhesive properties of residues such as limescale, grease and soap deposits. The TPA treatment helps with the cleaning and removal of the lime scale deposits and residues from the glass.

### How to clean the glass surfaces treated with TPA - (REGULAR MAINTENANCE)

- If possible always dry the shower enclosure after use
- Use a wet soft cloth when cleaning the glass
- The cleaning is made easier by a glass rubber wiper

### Don't use any of the following products to clean TPA treated glass

- DON'T use paste or abrasive products
- DON'T use bleach, solvents or very acidic products (such as Viakal or drain cleaner)
- DON'T use products containing silicone. They leave a film on the glass surface deleting completely the effects of TPA.

## Timeless® glass

Timeless glass, produced by a world-leading manufacturer of glass products, is designed specifically for shower enclosures and over bathscreens.

TIMELESS® prevents the appearance of the whitish veil that comes with glass corrosion over time, ensuring its transparency day after day.

The glass retains its initial appearance and transparency while resisting the combined effects of limescale, soap residue and corrosion. Thanks to its invisible magnetron deposition TIMELESS® remains perfectly smooth and transparent for a long time.

### How to clean TIMELESS® glass panes - (REGULAR MAINTENANCE)

TIMELESS® can be cleaned with a soft cloth and water or with glass squeegees. Common cleaning products can be used. Do not use products containing abrasive powders nor abrasive tools.



	TPA	Timeless
<b>type of product</b>	Anti-scaling nanotechnology	Magnetronic antioxidant deposit
<b>type of action</b>	Excellent flowability of water droplets	Excellent corrosion resistance over time. Low water droplet flowability
<b>appearance</b>	Imperceptible, no glass colour change	Perfect transparency slight change of reflections towards blue
<b>available finishes</b>	Available on all glass finishes. Suitable with decorations.	Only available in transparent finish. Not available with decorations.
<b>maintenance</b>	Cleaning with simple cloths and without the use of anti-scale products, Avoid chemically aggressive and abrasive products	Cleaning with soft cloth, tolerates aggressive anti-limescale products, avoid abrasive products.
<b>estimated duration * in normal domestic use</b>	5 years if no specific product is used. Renewable on demand	Estimated 10 years. Non-renewable.
<b>possibility of renewing the treatment</b>	Can be simply renewed when the effect wears off	Not restorable
<b>extra</b>	complimentary Virgola with each treated product	

\* The lasting effect of the treatment depends on the frequency of use of the shower enclosure and its cleaning with correct products. The chemical and physical characteristics of the water and in particular its hardness can influence the lasting of the treatment

# SMF

patented

## Product description

SMF easy mounting system

## Characteristics

It is a patented system combined to an innovative adjustability solution thus allowing an ideal panel positioning and at the same time avoiding the water leak.

SMF is available for Programmes Link, Supersintesi, Flare 2.0, Gliss, Sk-in, Linea, Twin, Sintesi, Replay, Serie 8000, Smack and bathscreens.

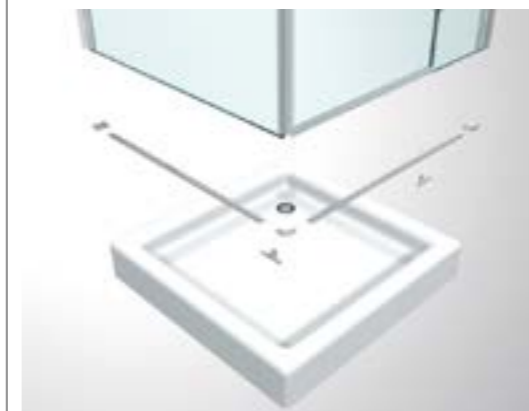

## Custom made

Every SMF is made to size, according to the shower enclosure dimension (same finish).

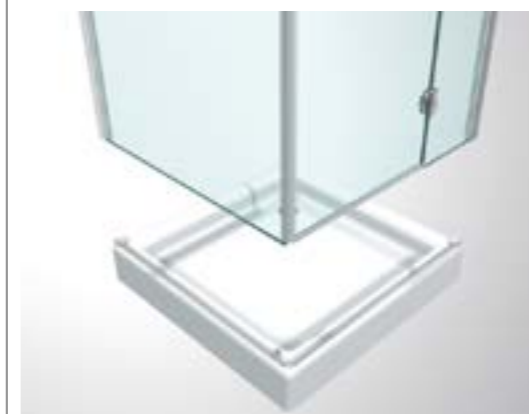

## Adjustment

SMF has to be positioned on the tray before the shower enclosure installation. This allows checking that the dimension of the shower enclosure is suitable to be mounted on the shower tray.



## Easy intallation

The positioning of the panels takes place easily, obtaining in full security the adaptability of the shower enclosure.



## Watertight

After the installation, the SMF kit has a function of water threshold.



## Technical specifications

These treatments do not eliminate glass cleaning, but makes it easier.

## PROFILES

All profiles are made by primary alloy EN AW-6060 extruded aluminium. The colours reproduced are indicative and may differ from the original ones.

### Anodisation \*

Anodizing, also called anodic oxidation, is a non-spontaneous electrochemical process by which a protective oxide layer forms on the surface of the treated metal. Such anodization of aluminium is a process with a double anticorrosive and aesthetic function.

### Multilayer enamelling \*\*

New finishes made with an innovative technology studied in collaboration with one important company international leader in paints for aluminum. They have been tested for a long time in the laboratory and in salt-fog rooms, with excellent results in terms of aesthetic performance and of resistance over time. This technology is used for 34 Matt Copper and 35 Matt Gold.

### Epoxy enamelling \*\*\*

The enamelling of the profiles is done by covering them with epoxy enamels adhering to them by electrostatic effect. The profiles are then passed into an oven where, due to the temperature, the paint first melts and then polymerizes, giving an adherent layer with a double anticorrosive and aesthetic function.



**34 Matt copper \*\***

Available for:  
- Frame  
- Link  
- Supersintesi  
- Serie F  
- Sk-in  
- Linea  
- Serie 8000



**32 Satin bronze \***

Available for:  
- Frame  
- Link  
- Supersintesi  
- Flare 2.0  
- Serie F  
- Sk-in  
- Linea  
- Sintesi  
- Replay  
- Serie 8000  
- Junior  
- Serie 7200

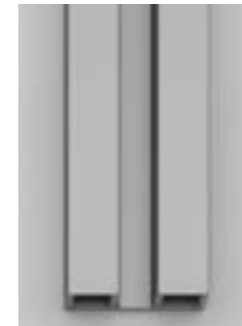

**31 Satin silver \***

Available for:  
- Frame  
- Link  
- Supersintesi  
- Flare 2.0  
- Serie F  
- Gliss  
- Sk-in  
- Linea  
- Sintesi  
- Replay  
- Serie 8000  
- Junior  
- Serie 7200



**33 Satin gold \***

Available for:  
- Frame  
- Link  
- Supersintesi  
- Serie F  
- Sk-in  
- Linea  
- Sintesi  
- Replay  
- Serie 8000

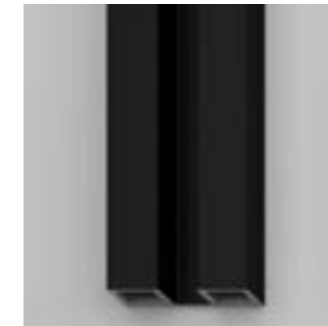

**09 Matt black \*** rif. RAL 9005

Available for all the programmes.



**07 Yellow \*\*\*** rif. RAL 1014

Available for:  
- Sk-in  
- Linea  
- Sintesi  
- Replay  
- Serie 8000



**12 Green \*\*\*** rif. RAL 6019

Available for:  
- Sk-in  
- Linea  
- Sintesi  
- Replay  
- Serie 8000



**14 White \*\*\*** rif. RAL 9003

Available for:  
- Frame  
- Link  
- Supersintesi  
- Serie F  
- Gliss  
- Sk-in  
- Linea  
- Sintesi  
- Replay  
- Serie 8000  
- Junior  
- Smack  
- Serie 7200



**54 Brushed copper \***

Available for:  
- Frame  
- Link  
- Serie F  
- Sk-in  
- Linea  
- Serie 8000



**52 Brushed bronze \***

Available for:  
- Frame  
- Serie F  
- Sk-in  
- Linea  
- Serie 8000



**61 Brushed steel finishing \***

Available for:  
- Frame  
- Link  
- Link  
- Supersintesi  
- Flare 2.0  
- Serie F  
- Sk-in  
- Linea  
- Serie 8000  
- Serie 7200



**35 Matt Gold \*\***

Available for:  
- Frame  
- Link  
- Supersintesi  
- Serie F  
- Sk-in  
- Linea  
- Serie 8000

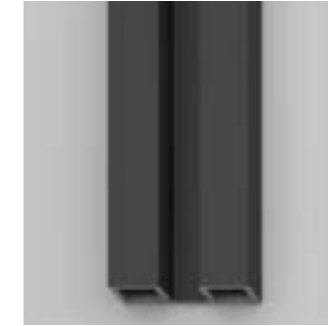

**39 Metal gun \*\*\***

Available for:  
- Frame  
- Link  
- Supersintesi  
- Serie F  
- Sk-in  
- Linea  
- Sintesi  
- Replay  
- Serie 8000  
- Junior  
- Serie 7200



**10 Pergamon \*\*\*** rif. RAL 9001

Available for:  
- Sk-in  
- Linea  
- Sintesi  
- Replay  
- Serie 8000

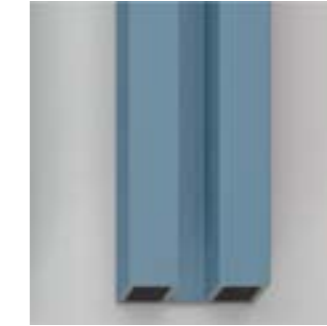

**13 Light blue \*\*\*** rif. RAL 5024

Available for:  
- Sk-in  
- Linea  
- Sintesi  
- Replay  
- Serie 8000



**15 Matt white \*\*\*** rif. RAL 9016

Available for:  
- Frame  
- Link  
- Supersintesi  
- Serie F  
- Sk-in  
- Linea  
- Sintesi  
- Replay  
- Serie 8000  
- Junior  
- Serie 7200

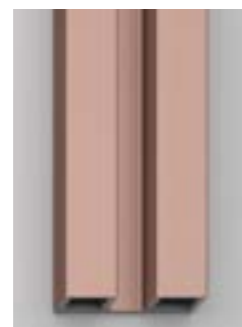

**84 Bond copper \*\*\***

Available for:  
- Frame  
- Link  
- Supersintesi  
- Serie F  
- Sk-in  
- Linea  
- Sintesi  
- Replay  
- Serie 8000  
- Junior  
- Serie 7200



**73 Dark bronze \*\*\***

Available for:  
- Frame  
- Link  
- Supersintesi  
- Serie F  
- Sk-in  
- Linea  
- Sintesi  
- Serie 8000



**21 Bright silver \***

Available for all the programmes.



**23 Bright gold \***

Available for:  
- Frame  
- Link  
- Supersintesi  
- Serie F  
- Sk-in  
- Linea  
- Sintesi  
- Replay  
- Serie 8000



**38 Moka \*\*\***

Available for:  
- Frame  
- Link  
- Supersintesi  
- Serie F  
- Sk-in  
- Linea  
- Sintesi  
- Replay  
- Serie 8000  
- Junior



**11 Grey \*\*\*** rif. RAL 7040

Available for:  
- Sk-in  
- Linea  
- Sintesi  
- Replay  
- Serie 8000



**05 Red \*\*\*** rif. RAL 3000

Available for:  
- Sk-in  
- Linea  
- Sintesi  
- Replay  
- Serie 8000

GLASSES



**SAFETY TEMPERED GLASS**

Monolithic glasses of thickness 4 or 6 or 8 or more, processed by controlled thermal treatments to increase strength compared with normal glass. In case of breakage, they fragment into very small pieces, with sides not sharp, such as not to cause harm to people. They meet with EN 14428: 2018 standard and comply with the required certifications.



**TEMPERED AND STRATIFIED SAFETY GLASS - SECURPLUS™**

It is composed of two tempered glasses and subsequently stratified by a plastic interlayer that ensures the perfect union of the components. The tempering of both glasses guarantees resistance to breakage and bending typical of this treatment. The bonding between the two glasses (stratification) guarantees, in the event of one or both glasses breaking, a sufficient rigidity of the unit avoiding the separation of the fragments, and maintaining the compactness of the whole and the dimensional characteristics unaltered. In addition, the plastic film used to couple the glass can have different colors or can be enriched with other materials such as metal mesh or special fabrics for a highly sought-after aesthetic effect. The tempered and laminated glass is the highest level of safety for shower elements according to the standard UNI EN 14422:2018 and also regulated by EN 14449 and EN ISO 12543.2 standards. In conclusion, the types of laminated tempered glass used in our shower enclosures are distinguished in the following variants:

- Securplus™ 4+4: these are two tempered transparent (float) 4mm glasses and laminated, with a total thickness of 8.5 mm.
- Securplus™ reeded: these are two glasses, one transparent (float) and one with a vertical wave pattern (reeded) on the outer face. The orientation of the decorations is always vertical.
- Securplus™ metal net: these are two tempered transparent (float) glasses and laminated with a metal mesh inserted between the two panes.
- Securplus™ custom: it is made of tempered and laminated glasses with a plastic interlayer or according to the customer request.



stratified  
glasses



**44 Securplus™ 4+4**  
these are two tempered and stratified 4mm transparent (float) glasses, with a total thickness of 8.5 mm.



**Securplus™ metal net:**  
these are two tempered transparent (float) glasses and laminated with a metal mesh inserted between the two panes.



**51 Securplus™ - silver net**  
stratified glass with a silver metal mesh

**53 Securplus™ - bronze net**  
stratified glass with a bronze metal mesh



**34 Securplus™ reeded**  
these are two glasses, one transparent (float) and one with a vertical wave pattern (reeded) on the outer face. The orientation of the decorations is always vertical.



**37 Securplus™ grey reeded**  
these are two glasses, one clear grey (float) and one with a vertical wave pattern (reeded) on the outer face. The orientation of the decorations is always vertical.

# tempered glasses

Glass is tempered conforming to the international safety standard.

# tempered special glasses



**01**  
Obscure glass



**03**  
Clear bronze glass



**08**  
Satin glass



**14**  
Extra-light satin glass



**04** Transparent glass



**05**  
Timeless®  
transparent anti-corrosion  
low maintenance glass.  
TPA and decorations are not  
available on this glass.



**24**  
Reeded glass



**29**  
Madras Nuvola glass



**12** Extra-light glass



**06**  
Reflecting glass



**07**  
Clear grey glass



**11**  
Cathedral glass



**10**  
Extra-reflex glass

decors

We use multiple technologies to decorate and customize the glass of our shower enclosures:

**Serigraphy** also known as **Silk-screen printing**: application by means of a silk-screen frame of special vitrifiable enamels, baked at 700 °C and unalterable. Monochromatic decorations with a low degree of customization are achievable.

**Personal Glass**: application by digital printer of special vitrifiable enamels, baked at 700° C and unalterable, Monochromatic or coloured decorations with a very high degree of customization are achievable (see page 14).

**Acidifying**: by etching erosion. Hand-crafted glassworker's exquisite workmanship.



\*  
please specify if left or right opening or position, even if the model is reversible.



**D 55 \***  
Serigraphy/Screen print

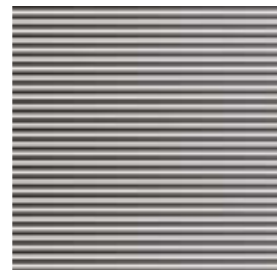

**D 60**  
Serigraphy/Screen print  
**P 60**  
Personal Glass  
(vertical lines available on request)

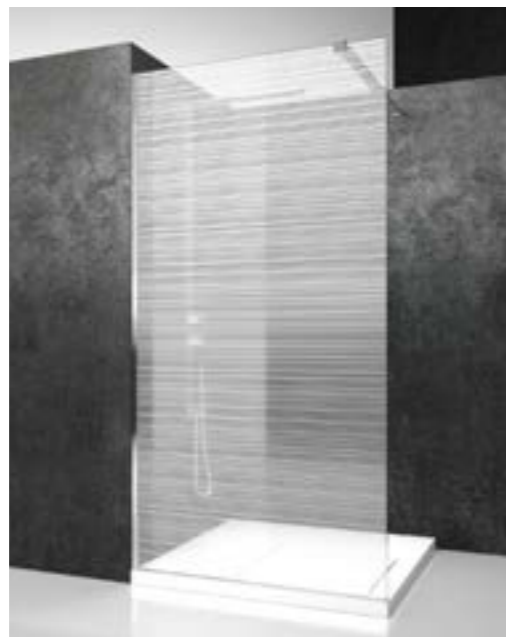

**D 61**  
Serigraphy/Screen print  
**P 60**  
Personal Glass  
(vertical lines available on request)



**D 50**  
Serigraphy/Screen print  
**P 50**  
Personal Glass  
**A 50**  
Acidifying

Decor's height:  
H 91 cm  
Vertically centered



**D 51**  
Serigraphy/Screen print  
**P 51**  
Personal Glass  
**A 51**  
Acidifying

Decor's height:  
H 87 cm  
Vertically centered



**D 52 \***  
Serigraphy/Screen print  
**P 52 \***  
Personal Glass  
**A 52 \***  
Acidifying

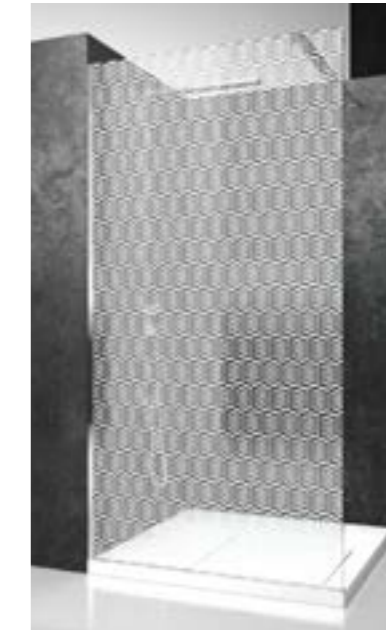

**P 70**  
Personal Glass

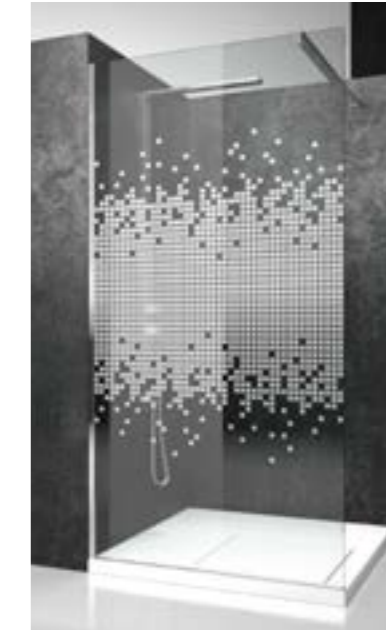

**D 54**  
Serigraphy/Screen print  
**P 54**  
Personal Glass

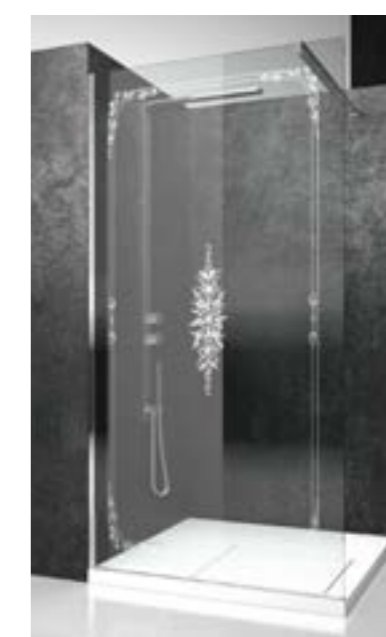

**P 56**  
Personal Glass



The name says it all: Personal Glass, the new Vismaravetro concept that embodies imagination and creativity. Personal Glass offers an extensive catalogue of patterns and decorations and, most importantly, the option of reproducing a selected photographic image on the shower enclosure using a high-resolution file.

Digital print is an innovative technology in the shower enclosure system: this technology permits to print the desired picture, obtaining a very customized shower. Indeed, on the glass you will be able to print images chosen from our catalogue or personalized. Images must be supplied in digital format (the most common digital formats employed in graphics are .tif, .eps, .pdf, .ai, .jpg), at 300 DPI and in high definition or in vector form (.dwg, .eps, .ai).



Glass printing can vary slightly from the video version or on other materials. Even the background behind the panel can have a subtle influence on the final appearance of the print

**To obtain the best result of the colorful prints it is advisable to quote the extra-clear glass option (code 12).**

For customized printing, it is advisable to require a sample of the printed glass and a detailed quotation



**Standard patterns**

Selection of standard designs to customize your shower. A wider selection of decors is available on the website : [www.vismaravetro.it](http://www.vismaravetro.it)



**P 16 AZULEJOS**

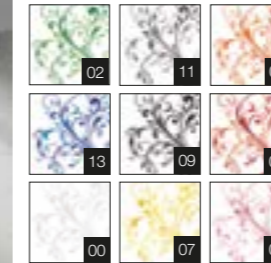

**P 15 ORGANIC**



**P 13 WATER DROPS**



**P 19 BLOW**



**FRAME DECOR**  
P30-09 Black  
P30-14 White



**VERTICAL DECOR**  
P31-09 Black  
P31-14 White



**SQUARE DECOR**  
P32-09 Black  
P32-14 White

collections

# LUXE

frame

pag 020

link

pag 032

supersintesi

pag 056

flare 2.0

pag 072

serie F

pag 086

gliss

pag 098

index by typology

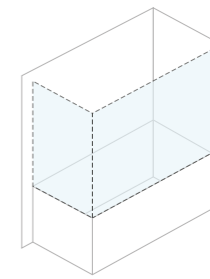
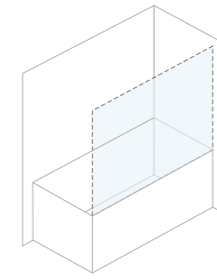
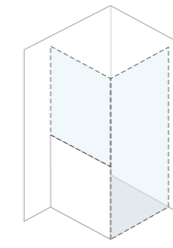
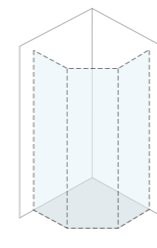
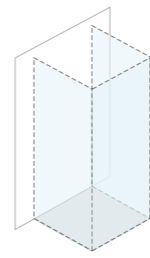
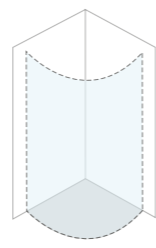
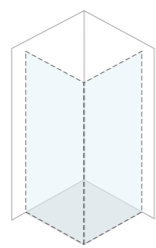
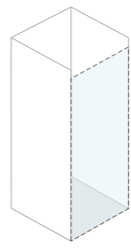

type	recess		corner		quadrant		3-sided		trial		side panel		bath screen 1 side		bath screen 2 sides	
	pag		pag	pag	pag	pag	pag	pag	pag	pag	pag	pag	pag	pag	pag	
frame	PKT	024	PKT	024			PKB	028								
	PKF	026	PKF	026			PKS	030								
link	KN	036	KA+KA	048			KC+KA+KF	052/048/050			KN+KP	036/054				
	KB	038	KA+KF	048/050			KC+KB+KC	052/038			KB+KP	038/054				
	K2	040	KB+KC	038/052			KG+KM+KG	052/044			K2+KP	040/054				
	KZ	042	K2+KC	040/050							KZ+KP	042/054				
	KM	044	K2+KG	040/052												
	K3	046	KZ+KF	042/050												
			KM+KG	044/052												
			K3+KG	046/052												
			K3+KC	046/052												
supersintesi	XN	060	XA+XA	064			XF+XA+XG	066/064/068			XN+XP	060/070				
	XM	062	XA+XF	064/066			XG+XM+XG	068/062			XM+XP	062/070				
			XN+XG	060/068												
			XM+XG	062/068												
flare 2.0	FN	076	FA+FA	080							FN+FP	076/194				
	F2	078	FA+FF	080/082												
			F2+FG	078/084												
serie F	HL	092											HV	314		
	HN	094														
	H2	096														
gliss	DN	102	DA+DA	112			DA+DA+DG	112/114			DN+DP	102/116				
	D3	104	DQ+DF	108/110			DG+DQ+DF	114/108/110			D3+DP	104/116				
	D4	106	DN+DG	102/114							D4+DP	106/116				
			D3+DG	104/114												
			D4+DG	106/114												

# frame

collection



compléments

bath  
screens

serie 7000

serie 8000

gliss

junior

replay

sintesi

super  
sintesi

linea/twin

serie F

flare 2.0

sk-in

# frame

The walk-in shower enclosure is the ultimate modern-day temptation and, spoiler alert, no one can resist it.

A desire for open spaces and complete freedom that Vismaravetro satisfies with **Frame**: the comprehensive range of walk-in showers framed with side or lengthwise supports, now also available in wall, recess and corner versions, breaking down any visual barrier.

The Securplus glass panels framed by a stylish aluminium surround give stability and ensure safety thanks to support bars that leave only the appeal of a minimalist and sleek design visible.

The quality of the materials, the endless customization options and Vismaravetro technology are the ever-present but invisible elements that give rise to spell-binding, contemporary installations.



The wall must be perpendicular to the door and the fixing base not less than 50 mm..

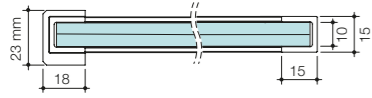

Profiles for models PKT and PKB. Suitable for Securplus™ laminated security glass.

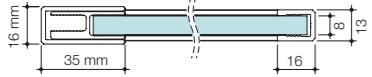

Profiles for models PKF and PKS. Suitable for monolithic glass 8 mm thick



**stabiliser rod**

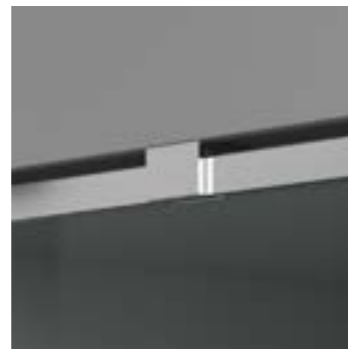

**ceiling clamp**

the glass remains far from the ceiling about 5 mm.



**wall profile**



**bottom profile**



**PST External towel holder**

(optional only for PKF and PKS) see page 326 for information and prices



**PSR External towel holder**

(optional only for PKF and PKS) see page 326 for information and prices

The complete range of Vismaravetro profiles is available upon request at the e-mail [info@vismaravetro.it](mailto:info@vismaravetro.it)

frame type

recess

PKT PKF

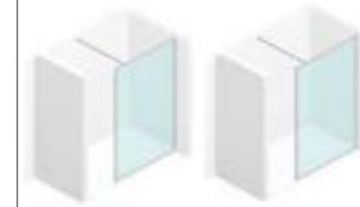

corner

PKT PKF



quadrant

3-sided

PKB PKS



side panel

Custom solutions

sk-in

flare 2.0

serie F

linea/twin

super sintesi

sintesi

replay

junior

gliss

serie 8000

serie 7000

bath screens

complements

**Product description**

Aluminium framed fix panel for recess or corner shower trays.

**Characteristics**

- Adjustability 5 mm.
- Double possibility of adjustment, lateral and longitudinal.
- Stabiliser rod PKR 120
- Reversible
- Product conforming to EN 14428:2018 with CE marking

**Materials**

- Securplus™ laminated glass
- Possibility to customize the choice of laminated glass with personalized combinations.
- Anodised or enamelled aluminium profiles .

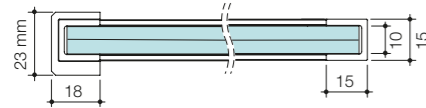

**Technical specifications**

The height of the panel PKT is always custom made. Prices refer to height between 170 and 210 cm.

If a specific height is not given, the element is supplied 200 cm high.



**PKT-M: MOPA version with clamp for ceiling fixing**

**No surcharge on PKT standard height.**  
An extra charge will be applied for special height products.  
Available in all finishes of PKT.  
Technical information: the glass is far from the ceiling about 5 mm.

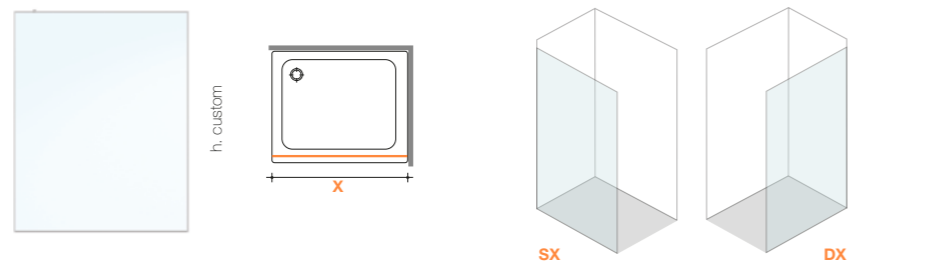

item	boxes	dimensions X
PKT 78÷180	1	PKT is always custom made (cm by cm).  Ex: PKT 116 = extensible element from cm 116 to cm 116,5

frame  
PKT

glasses

44 SECURPLUS™ - transparent glass	34 SECURPLUS™ - reeded glass	37 SECURPLUS™ - reeded grey glass	51 SECURPLUS™ - silver net glass	53 SECURPLUS™ - bronze net glass
--------------------------------------	---------------------------------	--------------------------------------	-------------------------------------	-------------------------------------

**MADE TO MEASURE**

Dimensions	item	profiles				
code	PKT 78 ... PKT 97	21 31	1.547,00	1.774,00	1.863,00	2.360,00
height	from 170 to 210 cm	09 14 15 39 61	1.593,00	1.819,00	1.908,00	2.405,00
		23 32 33 38 52 73 84	1.803,00	2.029,00	2.118,00	2.615,00
		34 35 54	2.666,00	2.893,00	2.981,00	3.479,00
code	PKT 98 ... PKT 117	21 31	1.705,00	1.974,00	2.073,00	2.675,00
height	from 170 to 210 cm	09 14 15 39 61	1.753,00	2.021,00	2.121,00	2.723,00
		23 32 33 38 52 73 84	1.966,00	2.234,00	2.334,00	2.936,00
		34 35 54	2.846,00	3.115,00	3.215,00	3.816,00
(1)						
code	PKT 118 ... PKT 137	21 31	1.873,00	2.159,00	2.268,00	2.977,00
height	from 170 to 210 cm	09 14 15 39 61	1.923,00	2.209,00	2.318,00	3.027,00
		23 32 33 38 52 73 84	2.140,00	2.426,00	2.535,00	3.245,00
		34 35 54	3.038,00	3.324,00	3.433,00	4.143,00
(1)						
code	PKT 138 ... PKT 157	21 31	2.051,00	2.338,00	2.455,00	3.273,00
height	from 170 to 210 cm	09 14 15 39 61	2.103,00	2.390,00	2.507,00	3.326,00
		23 32 33 38 52 73 84	2.325,00	2.612,00	2.729,00	3.548,00
		34 35 54	3.242,00	3.529,00	3.646,00	4.464,00
(1)						
code	PKT 158 ... PKT 180	21 31	2.241,00			
height	from 170 to 210 cm	09 14 15 39 61	2.297,00			
		23 32 33 38 52 73 84	2.523,00			
		34 35 54	3.460,00			
(1)						

for glasses 51 and 53  
maximum available  
measure PKT155

(1) Attention: packed in wooden box, with no extra cost

**OPTIONS**

Glass	TPA	167,00	from PKT 78 to PKT 97 - TPA virgola included
	TPA	205,00	from PKT 98 to PKT 180 - TPA virgola included
	Personal Glass	239,00	decors: P30-P31 (only available for Securplus 44 transparent)
	Securplus custom laminated glass	on offer	<a href="https://www.vismaravetro.it/en/glasses-shower-enclosure">https://www.vismaravetro.it/en/glasses-shower-enclosure</a> for info
Profiles	MOPA option	no extra charge	clamp for ceiling fixing used instead of hardening rod PKR120
			<b>important:</b> the distance between the shower tray and the ceiling must be provided with extreme precision (to the mm).
Special dimensions	Lower height	no extra charge	
	Higher height	+ 20%	higher height - max. cm 230
	Higher height	+ 30%	higher height - max. cm 250 (higher on request)



**Product description**

Separating wall.

**Characteristics**

Two stabiliser rods PKR 120 are included in the price.

Product conforming to EN14428:2018 with **CE** marking

**Materials**

Securplus laminated glass

Possibility to customize the choice of laminated glass with personalized combinations.

Anodised or enamelled aluminium profiles



**Technical specifications**

All the items are always packed in wooden boxes, with no extra cost.

frame  
PKB

glasses

**44** SECURPLUS™  
- transparent glass

**34** SECURPLUS™  
- reeded glass

**37** SECURPLUS™  
- reeded grey glass

**51** SECURPLUS™  
- silver net glass

**53** SECURPLUS™  
- bronze net glass

**MADE TO MEASURE**

Dimensions	item	profiles				
<b>PKB 118 .. PKB 137</b> from 170 to 210 cm	no adjustability	<b>21 31</b>	1.985,00	2.289,00	2.404,00	3.156,00
		<b>09 14 15 39 61</b>	2.038,00	2.341,00	2.456,00	3.209,00
		<b>23 32 33 38 52 73 84</b>	2.269,00	2.572,00	2.687,00	3.439,00
		<b>34 35 54</b>	3.220,00	3.524,00	3.640,00	4.391,00
<b>PKB 138 PKB 157</b> from 170 to 210 cm	no adjustability	<b>21 31</b>	2.174,00	2.478,00	2.603,00	3.470,00
		<b>09 14 15 39 61</b>	2.230,00	2.533,00	2.658,00	3.525,00
		<b>23 32 33 38 52 73 84</b>	2.465,00	2.768,00	2.894,00	3.761,00
		<b>34 35 54</b>	3.437,00	3.741,00	3.865,00	4.732,00
<b>PKB 158 PKB 177</b> from 170 to 210 cm	no adjustability	<b>21 31</b>	2.383,00			
		<b>09 14 15 39 61</b>	2.441,00			
		<b>23 32 33 38 52 73 84</b>	2.682,00			
		<b>34 35 54</b>	3.675,00			
<b>PKB 178 PKB 199</b> from 170 to 210 cm	no adjustability	<b>21 31</b>	2.602,00			
		<b>09 14 15 39 61</b>	2.662,00			
		<b>23 32 33 38 52 73 84</b>	2.908,00			
		<b>34 35 54</b>	3.924,00			

for glasses 51 and 53  
maximum available  
measure PKT155

**Attention:** packed in wooden box, with no extra cost

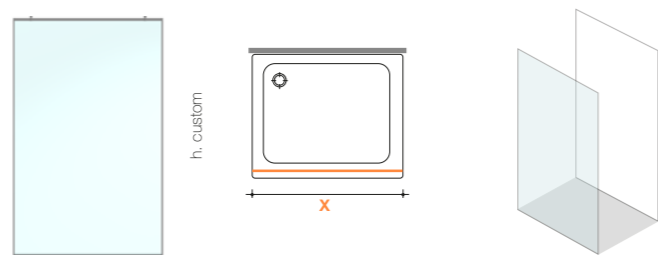

article	boxes	dimension of the installed shower tray X
<b>PKB 118÷199</b>	1	The separating wall "PKB" is always custom made (cm by cm).  Item code (expressed cm by cm) refers to the dimension of the element.

OPTIONS			
<b>Glass</b>	<b>TPA</b>	205,00	treatment preventing limescale TPA Virgola included
	<b>Personal Glass</b>	239,00	decors: P30-P31 (only available for Securplus 44 transparent)
	<b>Securplus custom laminated glass</b>	on offer	<a href="https://www.vismaravetro.it/en/glasses-shower-enclosure">https://www.vismaravetro.it/en/glasses-shower-enclosure</a> for info
<b>Profiles</b>			
<b>Special sizes</b>	<b>Lower height</b>	no extra charge	
	<b>Higher height</b>	+ 20%	max. cm 230
	<b>Higher height</b>	+ 30%	max. cm 250 (higher on request)

**Product description**

Separating wall.

**Characteristics**

Two stabiliser rods PKR 100 are included in the price.

External towel holder **PST-PSR** (optional) see pag. 326 for prices and finishings.

Product conforming to EN14428:2018 with **CE** marking

**Materials**

Tempered glass 8 mm

Anodised or enamelled aluminium profiles



**Technical specifications**

All the items are always packed in wooden boxes, with no extra cost.

frame  
PKS

glasses

04 clear glass

05 Timeless®  
anti-corrosion low  
maintenance glass.  
NO TPA available

03 clear bronze  
07 clear grey

01 obscure glass  
08 satin glass

06 reflecting  
10 extra-reflex

11 cathedral  
12 extra-light

14 satin extra-light  
29 madras nuvola

**MADE TO MEASURE**

codici	dimensione	profil					
<b>PKS 118 ... PKS 137</b> from 170 to 210 cm	no adjustability	21 31	1.643,00	1.774,00	1.909,00	2.145,00	2.324,00
		09 14 15 39 61	1.784,00	1.915,00	2.051,00	2.287,00	2.465,00
		23 32 33 38 52 73 84	1.949,00	2.080,00	2.217,00	2.452,00	2.631,00
		34 35 54	2.983,00	3.114,00	3.250,00	3.485,00	3.664,00
<b>PKS 138 ... PKS 157</b> from 170 to 210 cm	no adjustability	21 31	1.832,00	1.990,00	2.129,00	2.384,00	2.575,00
		09 14 15 39 61	1.976,00	2.135,00	2.272,00	2.527,00	2.720,00
		23 32 33 38 52 73 84	2.146,00	2.304,00	2.443,00	2.698,00	2.889,00
		34 35 54	3.199,00	3.358,00	3.495,00	3.751,00	3.943,00
<b>PKS 158 ... PKS 177</b> from 170 to 210 cm	no adjustability	21 31	2.039,00	2.224,00	2.337,00	2.384,00	2.575,00
		09 14 15 39 61	2.187,00	2.372,00	2.483,00	2.527,00	2.720,00
		23 32 33 38 52 73 84	2.362,00	2.547,00	2.660,00	2.698,00	2.889,00
		34 35 54	3.438,00	3.623,00	3.734,00	3.751,00	3.943,00
<b>PKS 178 ... PKS 199</b> from 170 to 210 cm	no adjustability	21 31	2.257,00	2.469,00	2.554,00	2.384,00	2.575,00
		09 14 15 39 61	2.408,00	2.620,00	2.704,00	2.527,00	2.720,00
		23 32 33 38 52 73 84	2.589,00	2.801,00	2.886,00	2.698,00	2.889,00
		34 35 54	3.686,00	3.898,00	3.983,00	3.751,00	3.943,00

Attention: packed in wooden box, with no extra cost

\* Cathedral max PKS 158

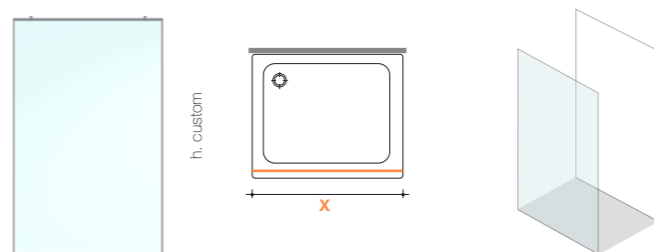

article	boxes	dimension of the installed shower tray X
<b>PKS 118÷199</b>	2	The separating wall "PKS" is always custom made (cm by cm).  Item code (expressed cm by cm) refers to the dimension of the element.

**OPTIONS**

External towel holder		PST - PSR	see page 326 for informations and prices
<b>Glass</b>	<b>TPA</b>	194,00	treatment preventing limescale TPA Virgola included
	<b>Personal Glass</b>	239,00	decors: P30-P31
	<b>Etched decor</b>	494,00	decors: A50 A51 A52 (max cm. 199)
<b>Profiles</b>			
<b>Special size</b>			
	<b>Lower height</b>	no extra charge	
	<b>Higher height</b>	+ 20%	max. cm 230
	<b>Higher height</b>	+ 30%	max. cm 250 (higher on request)

link  
collection



# link

**Link** is the result of a research aimed at integrating lines and space to the continuity between function and structure.

A superior technological evolution, pure expression of the design in its leanest and less permissive definition: less is more, or even better, if there is nothing more to be taken away then there is nothing more to be added.

**Link** it's a semi frameless shower enclosure with swing doors that presents truly surprising solutions: a single profile combines opening and adjustment functions. The profile itself acts as a hinge thanks to its capability to rotate on an up and down pin.

Everything in **Link** works by subtraction: the magnetic gaskets are inserted in a profile applied to the glass section, for a minimal effect, as well as the handle set recessed in the glass door.

The result is an extremely rigorous shower enclosure, where the lines go unnoticed also thanks to the complete absence of visible screw and relative covers.

Because the superfluous in **Link** is not expected.



The wall must be perpendicular to the door and the fixing base not less than 30 mm.

**The installation system needs a free space of 10/12 cm above the shower enclosure to operate with a screw-driver.**

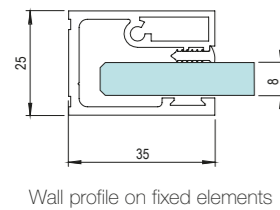
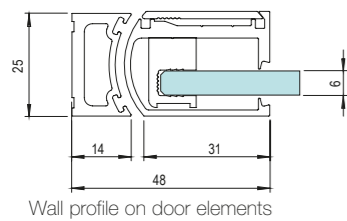

**The full range of Vismaravetro profiles is available upon request at the e-mail [info@vismaravetro.it](mailto:info@vismaravetro.it)**



magnetic seals

handle M16K

additional profile AD15



up&down movement.

As the door opens or closes, it moves up and down desengaging the lower seal and thus facilitating the opening.

## link type

### recess



### corner

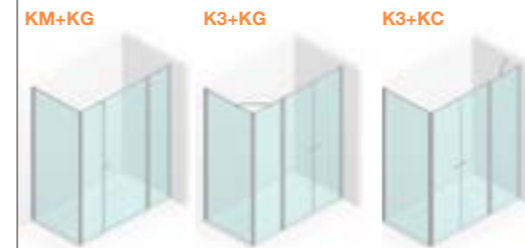

### 3-sided



### side panel



### Custom solutions

The collection Link fits to special configurations and bespoke solutions (such as special cuttings for small walls or underroof, models for people with reduced mobility, hotel or residential contracts, solutions for shipbuilding) Please send your enquiry to our technical office at [info@vismaravetro.it](mailto:info@vismaravetro.it)

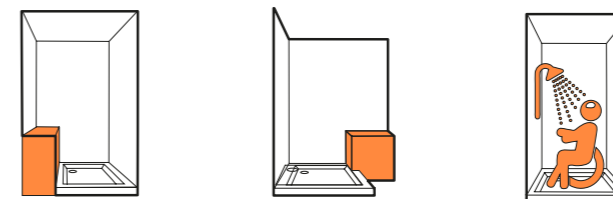

These examples are just indicative. Being customized solutions, it is necessary to submit an enquiry to our Technical Department so to check the feasibility and get an indication of the price.

**Product description**

Semi frameless shower enclosure, with a pivot door (180°) with up&down movement.

**Characteristics**

Adjustability **25** mm, obtained without the extension of the wall profile, which retains its aesthetic.

Extension can be increased by **15** mm with the additional profile AD15.

As the door opens or closes, it moves up and down desengaging the lower seal and thus facilitating the opening.

Double possibility of adjustment, lateral and longitudinal, after installation, for an easy final regulation before sealing.

The magnetic seals are applied to the aluminium profiles along the glass section: minimal dimensions and design.

Items in matt black **09**, moka **38** or metal gun **39** finishing are equipped with black seals.

Inward and outward opening.

S.M.F. (easily mounting system).

Product conforming to EN 14428:2018 with **CE** marking.

**Materials**

Tempered safety glass 6 mm.

Anodised or enamelled aluminium profiles.



**Technical specifications**

**Please, always advise the exact dimensions of the recess X.**

**Please always specify if left SX or right DX opening.**

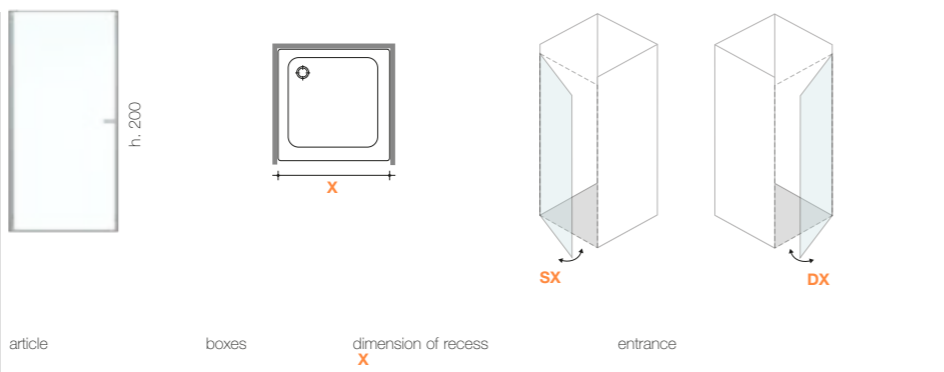

article	boxes	dimension of recess X	entrance
<b>KN 68÷99</b>	1	Link KN shower enclosure is always custom made (cm by cm).  Ex.: <b>KN 69</b> = shower enclosure for a recess dimension between cm. 69 and 71.5.	The entrance to the shower enclosure is approximately 8 cm (±1) less than the niche.  Ex. : niche of 89 cm; entry: 81 cm

**! ATTENTION:** Link shower enclosures are designed to be installed on a standard shower tray. In the case of installation on the floor or on special shower trays that may need a custom size, the installation layout sheet (see pages 338-339 of the general pricelist) must be complete and attached to the order.

<b>04</b> clear glass	<b>04 + TPA</b> Transparent with TPA (virgola included)			
-----------------------	--	--	--	--

**STANDARD DIMENSIONS**

codes	dimension of recess	profiles		
<b>KN 67</b>	67-69,5	<b>21</b> bright silver	<b>1.241,00</b>	<b>1.358,00</b>
<b>KN 77</b>	77-79,5	<b>21</b> bright silver	<b>1.298,00</b>	<b>1.415,00</b>
<b>KN 87</b>	87-89,5	<b>21</b> bright silver	<b>1.322,00</b>	<b>1.439,00</b>

**! ATTENTION**  
the model KN in standard dimension cannot be combined with other elements

<b>04</b> clear glass	<b>05</b> Timeless® anti-corrosion low maintenance glass. <b>NO TPA</b> available	<b>03</b> clear bronze <b>07</b> clear grey	<b>01</b> obscure glass <b>08</b> satin glass <b>11</b> cathedral <b>12</b> extra-light	<b>06</b> reflecting <b>10</b> extra-reflex <b>14</b> satin extra-light <b>29</b> madras nuvola
-----------------------	---	--	--	--

**MADE TO MEASURE**

codes	dimension of recess	profiles					
<b>KN 68 ... KN 77</b>	+ 25 mm adjustability on item code measure	<b>31</b>	1.390,00	1.483,00	1.492,00	1.577,00	1.712,00
		<b>21</b>	1.411,00	1.504,00	1.513,00	1.598,00	1.733,00
		<b>09 - 14 - 39 - 61</b>	1.554,00	1.647,00	1.656,00	1.742,00	1.876,00
<b>KN 78 ... KN 87</b>	+ 25 mm adjustability on item code measure	<b>31</b>	1.421,00	1.526,00	1.537,00	1.643,00	1.788,00
		<b>21</b>	1.437,00	1.543,00	1.554,00	1.659,00	1.805,00
		<b>09 - 14 - 39 - 61</b>	1.581,00	1.686,00	1.697,00	1.803,00	1.948,00
<b>KN 88 ... KN 99</b>	+ 25 mm adjustability on item code measure	<b>31</b>	1.443,00	1.564,00	1.572,00	1.692,00	1.848,00
		<b>21</b>	1.463,00	1.584,00	1.592,00	1.712,00	1.868,00
		<b>09 - 14 - 39 - 61</b>	1.607,00	1.728,00	1.736,00	1.856,00	2.012,00

**OPTIONS - For customized solutions the additional costs have to be applied on made to measure prices**

<b>Glass</b>	<b>TPA</b>	133,00	treatment preventing limescale TPA Virgola included
	<b>Screen print</b>	144,00	decors: D50 D51 D52 D54 D55 D60 D61
	<b>Personal Glass</b>	222,00	decors: P56 P70
<b>Profiles</b>	<b>32</b>	+ 20%	on bright silver 21
	<b>15 / 23 / 33 / 38 / 73 / 84</b>	+ 25%	on bright silver 21
	<b>34 / 35 / 54</b>	1.854,00	on bright silver 21
<b>Special sizes</b>	<b>Lower height</b>	+ 5%	less than cm 200
	<b>Higher height</b>	+ 15%	higher height - max. cm 215
	<b>Higher height</b>	+ 30%	higher height - max. cm 230 - till max KN 87
	<b>Special width</b>	no extra charge	less than cm 68 (min cm 50)

**Product description**

Semi frameless shower enclosure, with two pivot doors (180°) with up&down movement.

**Characteristics**

Adjustability **30** mm, obtained without the extension of the wall profile, which retains its aesthetic.

Extension can be increased by **15** mm with the additional profile AD15.

It can be assembled with **KC** to obtain a corner or 3-sided shower enclosure.

As the door opens or closes, it moves up and down disengaging the lower seal and thus facilitating the opening.

Double possibility of adjustment, lateral and longitudinal, after installation, for an easy final regulation before sealing.

The magnetic seals are applied to the aluminium profiles along the glass section: minimal dimensions and design.

Items in matt black **09**, moka **38** or metal gun **39** finishing are equipped with black seals.

Inward and outward opening.

S.M.F. (easily mounting system).

Product conforming to EN 14428:2018 with  marking.

**Materials**

Tempered safety glass 6 mm.

Anodised or enamelled aluminium profiles.



**Technical specifications**

Please, always advise the exact dimensions of the recess **X**.

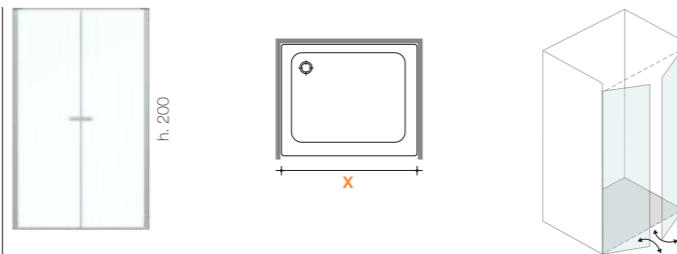

article	boxes	dimension of recess <b>X</b>	opening
<b>KB 78+95</b>	1	Link KB shower enclosure is always custom made (cm by cm).	The dimension of the door is approximately 1/2 of the recess.
<b>KB 96+159</b>	2		
		Ex.: <b>KB 105</b> = shower enclosure for a recess dimension between cm. 105 and 108.	

 **ATTENTION:** Link shower enclosures are designed to be installed on a standard shower tray. In the case of installation on the floor or on special shower trays that may need a custom size, the installation layout sheet (see pages 338-339 of the general pricelist) must be complete and attached to the order.

link  
KB

glasses

codes	dimension of recess	profiles	04 clear glass	04 + TPA Transparent with TPA (Virgola included)
<b>KB 87</b>	87-90	<b>21</b> bright silver	<b>1.706,00</b>	<b>1.839,00</b>
<b>KB 97</b>	97-100	<b>21</b> bright silver	<b>1.784,00</b>	<b>1.917,00</b>
<b>KB 117</b>	117-120	<b>21</b> bright silver	<b>1.935,00</b>	<b>2.068,00</b>

 **ATTENTION**  
the model KB in standard dimension cannot be combined with other elements

glasses

codes	dimension of recess	profiles	04 clear glass	05 Timeless® anti-corrosion low maintenance glass. NO TPA available.	03 clear bronze 07 clear grey	01 obscure glass 08 satin glass 11 katedral 12 extra-light	06 reflecting 10 extra-reflex 14 satin extra-light 29 madras nuvola
<b>KB 78 ... KB 87</b>	+ 30 mm adjustability on item code measure	<b>31</b>	1.916,00	2.019,00	2.054,00	2.123,00	2.290,00
		<b>21</b>	1.939,00	2.042,00	2.077,00	2.147,00	2.313,00
		<b>09 - 14 - 39 - 61</b>	2.113,00	2.217,00	2.251,00	2.321,00	2.488,00
<b>KB 88 ... KB 97</b>	+ 30 mm adjustability on item code measure	<b>31</b>	1.951,00	2.067,00	2.101,00	2.189,00	2.364,00
		<b>21</b>	1.974,00	2.089,00	2.123,00	2.211,00	2.387,00
		<b>09 - 14 - 39 - 61</b>	2.149,00	2.264,00	2.299,00	2.387,00	2.562,00
<b>KB 98 ... KB 107</b>	+ 30 mm adjustability on item code measure	<b>31</b>	2.048,00	2.177,00	2.216,00	2.321,00	2.510,00
		<b>21</b>	2.069,00	2.198,00	2.237,00	2.342,00	2.531,00
		<b>09 - 14 - 39 - 61</b>	2.251,00	2.380,00	2.419,00	2.524,00	2.713,00
<b>KB 108 ... KB 117</b>	+ 30 mm adjustability on item code measure	<b>31</b>	2.082,00	2.224,00	2.257,00	2.384,00	2.585,00
		<b>21</b>	2.103,00	2.246,00	2.278,00	2.405,00	2.606,00
		<b>09 - 14 - 39 - 61</b>	2.291,00	2.433,00	2.465,00	2.593,00	2.794,00
<b>KB 118 ... KB 127</b>	+ 30 mm adjustability on item code measure	<b>31</b>	2.118,00	2.272,00	2.302,00	2.449,00	2.660,00
		<b>21</b>	2.139,00	2.293,00	2.323,00	2.470,00	2.681,00
		<b>09 - 14 - 39 - 61</b>	2.331,00	2.485,00	2.515,00	2.662,00	2.873,00
<b>KB 128 ... KB 137</b>	+ 30 mm adjustability on item code measure	<b>31</b>	2.152,00	2.320,00	2.347,00	2.512,00	2.732,00
		<b>21</b>	2.173,00	2.341,00	2.368,00	2.533,00	2.753,00
		<b>09 - 14 - 39 - 61</b>	2.371,00	2.539,00	2.565,00	2.731,00	2.950,00
<b>KB 138 ... KB 159</b>	+ 30 mm adjustability on item code measure	<b>31</b>	2.206,00	2.399,00	2.442,00	2.640,00	2.903,00
		<b>21</b>	2.226,00	2.419,00	2.462,00	2.660,00	2.923,00
		<b>09 - 14 - 39 - 61</b>	2.424,00	2.617,00	2.661,00	2.858,00	3.121,00

**OPTIONS - For customized solutions the additional costs have to be applied on made to measure prices**

<b>Glass</b>	<b>TPA</b>	144,00	treatment preventing limescale TPA Virgola included
	<b>Screen print</b>	200,00	decors: D50 D51 D52 D54 D55 D60 D61
	<b>Personal Glass</b>	294,00	decors: P56 P70
<b>Profiles</b>	<b>32</b>	+ 20%	on bright silver 21
	<b>15 / 23 / 33 / 38 / 73 / 84</b>	+ 25%	on bright silver 21
	<b>34 / 35 / 54</b>	2.320,00	on bright silver 21
<b>Special sizes</b>	<b>Lower height</b>	+ 5%	less than cm 200
	<b>Higher height</b>	+ 15%	higher height - max. cm 215
	<b>Higher height</b>	+ 30%	higher height - max. cm 230
	<b>Special width</b>	no extra charge	less than cm 68 (min cm 60)





**Product description**

Semi frameless shower enclosure with one pivot door (180°) with up&down movement and two in line fixed elements.

**Characteristics**

Adjustability **45** mm, obtained without the extension of the wall profile, which retains its aesthetic.

Extension can be increased by **15** mm with the additional profile AD15.

It can be assembled with **KG** to obtain a corner shower enclosure.

As the door opens or closes, it moves up and down desengaging the lower seal and thus facilitating the opening.

Inward and outward opening.

Double possibility of adjustment, lateral and longitudinal, after installation, for an easy final regulation before sealing.

The magnetic seals are applied to the aluminium profiles along the glass section: minimal dimensions and design.

Items in matt black **09**, moka **38** or metal gun **39** finishing are equipped with black seals.

S.M.E. (easily mounting system)

Product conforming to EN 14428:2018 with **CE** marking

**Materials**

Tempered safety glass 6 mm for the door.  
Tempered safety glass 8 mm for the fix elements.

Anodised or enamelled aluminium profiles.



**Technical specifications**

**Please, always advise the exact dimensions of the installed shower tray X and specify if left SX or right DX opening.**

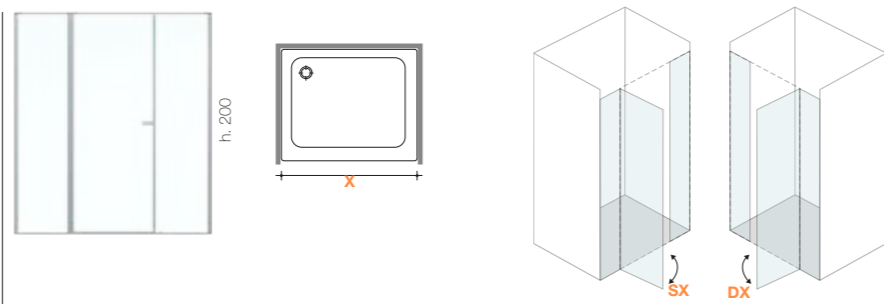

article	boxes	dimension of recess X	opening
<b>KM 138÷179</b>	3	Link KM shower enclosure is always custom made (cm by cm).  Ex.: <b>KM 145</b> = shower enclosure for a recess dimension between cm. 145 and 149,5.	For this model KM, unless specific requests, the dimension of the door is approximately 1/2 of the recess. (max cm. 80)

**ATTENTION:** Link shower enclosures are designed to be installed on a standard shower tray. In the case of installation on the floor or on special shower trays that may need a custom size, the installation layout sheet (see pages 338-339 of the general pricelist) must be complete and attached to the order.

<b>04</b> clear glass	<b>05</b> Timeless® anti-corrosion low maintenance glass. NO TPA available	<b>03</b> clear bronze	<b>01</b> obscure glass	<b>06</b> reflecting
		<b>07</b> clear grey	<b>08</b> satin glass	<b>10</b> extra-reflex
			<b>11</b> cathedral	<b>14</b> satin extra-light
			<b>12</b> extra-light	<b>29</b> madras nuvola

**MADE TO MEASURE**

codes	dimension of recess	profiles					
<b>KM 138 ... KM 147</b>	+ 45 mm adjustability on item code measure	<b>31</b>	2.298,00	2.478,00	2.530,00	2.726,00	2.981,00
		<b>21</b>	2.303,00	2.483,00	2.535,00	2.732,00	2.987,00
		<b>09 - 14 - 39 - 61</b>	2.495,00	2.675,00	2.727,00	2.924,00	3.179,00
<b>KM 148 ... KM 157</b>	+ 45 mm adjustability on item code measure	<b>31</b>	2.341,00	2.534,00	2.594,00	2.818,00	3.087,00
		<b>21</b>	2.347,00	2.540,00	2.600,00	2.824,00	3.092,00
		<b>09 - 14 - 39 - 61</b>	2.540,00	2.733,00	2.793,00	3.017,00	3.286,00
<b>KM 158 ... KM 167 (1)</b>	+ 45 mm adjustability on item code measure	<b>31</b>	2.516,00	2.723,00	2.793,00	3.040,00	3.321,00
		<b>21</b>	2.520,00	2.726,00	2.796,00	3.044,00	3.324,00
		<b>09 - 14 - 39 - 61</b>	2.726,00	2.933,00	3.003,00	3.250,00	3.531,00
<b>KM 168 ... KM 179 (1)</b>	+ 45 mm adjustability on item code measure	<b>31</b>	2.561,00	2.779,00	2.853,00	3.111,00	3.403,00
		<b>21</b>	2.563,00	2.782,00	2.855,00	3.114,00	3.405,00
		<b>09 - 14 - 39 - 61</b>	2.771,00	2.989,00	3.062,00	3.321,00	3.613,00

**(1)** in addition to the top profile, one corner fixing bracket "Z" for fixed element till 70 cm or a straight stabilizer bar "Z" for fixed element over 70 cm is always provided.

**OPTIONS - For customized solutions the additional costs have to be applied on made to measure prices**

Category	Option	Cost	Description
<b>Glass</b>	<b>TPA</b>	205,00	treatment preventing limescale TPA Virgola included
	<b>Screen print</b>	222,00	decors: D50 D51 D52 D54 D55 D60 D61
	<b>Personal Glass</b>	333,00	decors: P56 P70
<b>Profiles</b>	<b>32</b>	+ 20%	on bright silver 21
	<b>15 / 23 / 33 / 38 / 73 / 84</b>	+ 25%	on bright silver 21
	<b>34 / 35 / 54</b>	2.792,00	on bright silver 21
<b>Special sizes</b>	<b>Lower height</b>	+ 5%	less than cm 200
	<b>Higher height</b>	+ 15%	higher height - max. cm 215
	<b>Higher height</b>	+ 30%	higher height - max. cm 230 - till door's dimension max cm. 80
	<b>Special width</b>	+ 10% on KM 138	less than cm 138 (min cm 120)
	<b>Special width</b>	+ 10%	special width fixed panels

**Product description**

Semi frameless shower enclosure with two pivot doors (180°) with up&down movement and an in line fixed element.

**Characteristics**

Adjustability **45** mm, obtained without the extension of the wall profile, which retains its aesthetic.

Extension can be increased by **15** mm with the additional profile AD15.

It can be assembled with **KG** or with **KC** to obtain a corner shower enclosure.

As the door opens or closes, it moves up and down desengaging the lower seal and thus facilitating the opening.

Inward and outward opening.

Double possibility of adjustment, lateral and longitudinal, after installation, for an easy final regulation before sealing.

The magnetic seals are applied to the aluminium profiles along the glass section: minimal dimensions and design.

Items in matt black **09**, moka **38** or metal gun **39** finishing are equipped with black seals.

S.M.E. (easily mounting system)

Product conforming to EN 14428:2018 with **CE** marking.

**Materials**

Tempered safety glass 6 mm for the doors.  
Tempered safety glass 8 mm for the fix element.

Anodised or enamelled aluminium profiles.



**Technical specifications**

Please, always advise the exact dimensions of the recess **X** and specify if left **SX** or right **DX** opening.

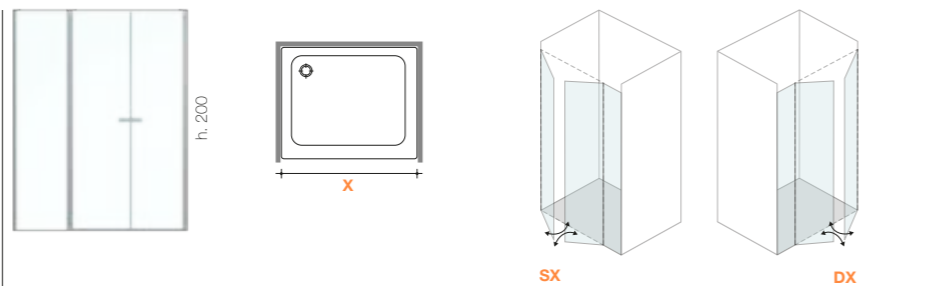

article	boxes	dimension of recess <b>X</b>	opening
<b>K3 138÷143</b>	2	Link "K3" shower enclosure is always custom made (cm by cm).  Ex.: <b>K3 145</b> = shower enclosure for a recess dimension between cm. 145 and 149,5.	Unless specific requests, the dimension of the doors is approximately 2/3 of the recess.
<b>K3 144÷179</b>	3		

**ATTENTION:** Link shower enclosures are designed to be installed on a standard shower tray. In the case of installation on the floor or on special shower trays that may need a custom size, the installation layout sheet (see pages 338-339 of the general pricelist) must be complete and attached to the order.

<b>04</b> clear glass	<b>05</b> Timeless® anti-corrosion low maintenance glass. NO TPA available	<b>03</b> clear bronze	<b>01</b> obscure glass	<b>06</b> reflecting
		<b>07</b> clear grey	<b>08</b> satin glass	<b>10</b> extra-reflex
			<b>11</b> katedral	<b>14</b> satin extra-light
			<b>12</b> extra-light	<b>29</b> madras nuvola

**MADE TO MEASURE**

codes	dimension of recess	profiles					
<b>K3 138 ... K3 147 (1)</b>	+ 45 mm adjustability on item code measure	<b>31</b>	2.718,00	2.898,00	2.958,00	3.158,00	3.438,00
		<b>21</b>	2.727,00	2.907,00	2.967,00	3.167,00	3.447,00
		<b>09 - 14 - 39 - 61</b>	2.939,00	3.119,00	3.179,00	3.379,00	3.659,00
<b>K3 148 ... K3 157 (1)</b>	+ 45 mm adjustability on item code measure	<b>31</b>	2.842,00	3.035,00	3.107,00	3.329,00	3.617,00
		<b>21</b>	2.848,00	3.041,00	3.114,00	3.336,00	3.624,00
		<b>09 - 14 - 39 - 61</b>	3.064,00	3.257,00	3.329,00	3.551,00	3.839,00
<b>K3 158 ... K3 167 (1)</b>	+ 45 mm adjustability on item code measure	<b>31</b>	2.885,00	3.091,00	3.171,00	3.419,00	3.720,00
		<b>21</b>	2.892,00	3.098,00	3.178,00	3.425,00	3.726,00
		<b>09 - 14 - 39 - 61</b>	3.117,00	3.323,00	3.403,00	3.651,00	3.952,00
<b>K3 168 ... K3 179 (1)</b>	+ 45 mm adjustability on item code measure	<b>31</b>	2.925,00	3.144,00	3.227,00	3.485,00	3.798,00
		<b>21</b>	2.935,00	3.154,00	3.237,00	3.495,00	3.808,00
		<b>09 - 14 - 39 - 61</b>	3.161,00	3.380,00	3.463,00	3.722,00	4.035,00

(1) in addition to the top profile, one corner fixing bracket "Z" for fixed element till 70 cm or a straight stabilizer bar "Z" for fixed element over 70 cm is always provided.

**OPTIONS - For customized solutions the additional costs have to be applied on made to measure prices**

Category	Option	Price	Description
Glass	TPA	205,00	treatment preventing limescale TPA Virgola included
	Screen print	222,00	decors: D50 D51 D52 D54 D55 D60 D61
	Personal Glass	333,00	decors: P56 P70
Profiles	<b>32</b>	+ 20%	on bright silver 21
	<b>15 / 23 / 33 / 38 / 73 / 84</b>	+ 25%	on bright silver 21
	<b>34 / 35 / 54</b>	3.086,00	on bright silver 21
Special sizes	<b>Lower height</b>	+ 5%	less than cm 200
	<b>Higher height</b>	+ 15%	higher height - max. cm 215
	<b>Higher height</b>	+ 30%	higher height - max. cm 230
	<b>Special width</b>	+ 10% on K3 138	less than cm 138 (min cm 120)
	<b>Special width</b>	+ 10%	special width fixed panels

**Product description**

Semi frameless pivoting (180°) shower door, with up&down movement.  
It can be assembled with a fix element **KF** or with another **KA** to obtain a corner shower enclosure.

**Characteristics**

Adjustability **15 mm**, obtained without the extension of the wall profile, which retains its aesthetic.

Extension can be increased by **15 mm** with the additional profile AD15.

As the door opens or closes, it moves up and down desengaging the lower seal and thus facilitating the opening.

Double possibility of adjustment, lateral and longitudinal, after installation, for an easy final regulation before sealing.

The magnetic seals are applied to the aluminium profiles along the glass section, if combined with a fixed element **KF**.

In the corner configuration **KA+KA** there are magnetic gaskets in PVC fixed directly on the glass.

Items in matt black **09**, moka **38** or metal gun **39** finishing are equipped with black seals.

**KA+KA**: inward and outward opening.  
**KA+KF**: only outward opening.

S.M.F. (easily mounting system)

Product conforming to EN 14428:2018 with **CE** marking.

**Materials**

Tempered safety glass 6 mm.  
Anodised or enamelled aluminium profiles.



**Technical specifications**

**Please, always advise the exact dimensions of the installed shower tray and specify if left **SX** or right **DX** opening.**

**In the corner configuration **KA+KA** there are magnetic gaskets in PVC fixed directly on the glass.**

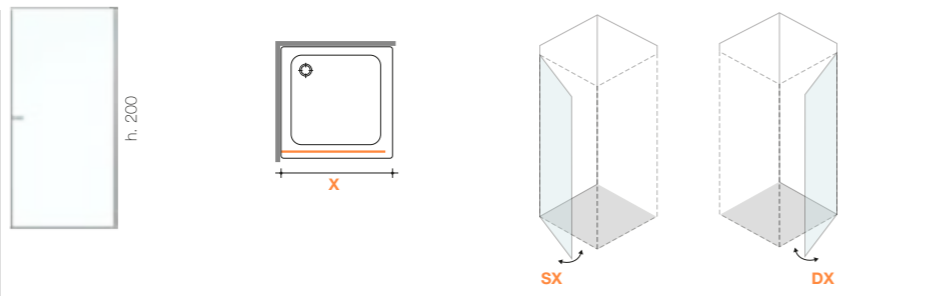

article	boxes	dimension of the installed shower tray <b>X</b>
<b>KA 68+99</b>	1	Link KA shower enclosure is always custom made (cm by cm).  Ex.: <b>KA 82</b> = shower enclosure for a recess dimension between cm. 82 and 83,5.

**! ATTENTION:** Link shower enclosures are designed to be installed on a standard shower tray. In the case of installation on the floor or on special shower trays that may need a custom size, the installation layout sheet (see pages 338-339 of the general pricelist) must be complete and attached to the order.

<b>04</b> clear glass	<b>04 + TPA</b> Transparent with TPA (virgola included)			
-----------------------	--	--	--	--

**STANDARD DIMENSIONS**

codes	dimension of shower tray	profiles			
<b>KA 68</b>	68-69,5	<b>21</b> bright silver	<b>1.083,00</b>	<b>1.200,00</b>	<b>! ATTENTION</b> <b>The model KA in standard dimension can be combined exclusively with an element KF.</b>
<b>KA 78</b>	78-79,5	<b>21</b> bright silver	<b>1.107,00</b>	<b>1.224,00</b>	
<b>KA 88</b>	88-89,5	<b>21</b> bright silver	<b>1.131,00</b>	<b>1.248,00</b>	

<b>04</b> clear glass	<b>05</b> Timeless® anti-corrosion low maintenance glass. <b>NO TPA</b> available	<b>03</b> clear bronze <b>07</b> clear grey	<b>01</b> obscure glass <b>08</b> satin glass <b>11</b> cathedral <b>12</b> extra-light	<b>06</b> reflecting <b>10</b> extra-reflex <b>14</b> satin extra-light <b>29</b> madras nuvola
-----------------------	---	--	--	--

**MADE TO MEASURE**

codes	dimension of shower tray	profiles					
<b>KA 68 ... KA 77</b>	+ 15 mm adjustability on item code measure	<b>31</b>	1.171,00	1.264,00	1.278,00	1.363,00	1.472,00
		<b>21</b>	1.178,00	1.271,00	1.284,00	1.370,00	1.479,00
		<b>09 - 14 - 39 - 61</b>	1.288,00	1.381,00	1.394,00	1.480,00	1.588,00
<b>KA 78 ... KA 87</b>	+ 15 mm adjustability on item code measure	<b>31</b>	1.192,00	1.298,00	1.314,00	1.415,00	1.535,00
		<b>21</b>	1.203,00	1.309,00	1.325,00	1.426,00	1.546,00
		<b>09 - 14 - 39 - 61</b>	1.314,00	1.420,00	1.436,00	1.537,00	1.657,00
<b>KA 88 ... KA 99</b>	+ 15 mm adjustability on item code measure	<b>31</b>	1.219,00	1.340,00	1.360,00	1.470,00	1.600,00
		<b>21</b>	1.230,00	1.351,00	1.371,00	1.481,00	1.611,00
		<b>09 - 14 - 39 - 61</b>	1.345,00	1.466,00	1.486,00	1.596,00	1.726,00

**OPTIONS - For customized solutions the additional costs have to be applied on made to measure prices**

<b>Glass</b>	<b>TPA</b>	133,00	treatment preventing limescale TPA Virgola included
	<b>Screen print</b>	144,00	decors: D50 D51 D52 D54 D55 D60 D61
	<b>Personal Glass</b>	222,00	decors: P56 P70
<b>Profiles</b>	<b>32</b>	+ 20%	on bright silver 21
	<b>15 / 23 / 33 / 38 / 73 / 84</b>	+ 25%	on bright silver 21
	<b>34 / 35 / 54</b>	1.249,00	on bright silver 21
<b>Special sizes</b>	<b>Lower height</b>	+ 5%	less than cm 200
	<b>Higher height</b>	+ 15%	higher height - max. cm 215
	<b>Higher height</b>	+ 30%	higher height - max. cm 230 - till max KA 87
	<b>Special width</b>	no extra charge	less than cm 68 (min cm 50)

**Product description**

Fixed panel, can be combined with **KA** or **KZ** door to obtain a corner shower enclosure.

**Characteristics**

Adjustability **15** mm, obtained without the extension of the wall profile, which retains its aesthetic.

Extension can be increased by **15** mm with the additional profile AD15.

Double possibility of adjustment, lateral and longitudinal, after installation, for an easy final regulation before sealing.

The magnetic seals are applied to the aluminium profiles along the glass section: minimal dimensions and design.

Items in matt black **09**, moka **38** or metal gun **39** finishing are equipped with black seals.

S.M.E. (easily mounting system)

Product conforming to EN 14428:2018 with **CE** marking.

**Materials**

Tempered safety glass 8 mm.

Anodised or enamelled aluminium profiles.



**Technical specifications**

Please, always specify if left **SX** or right **DX** opening.

Please, always advise the exact dimensions of the installed shower tray.

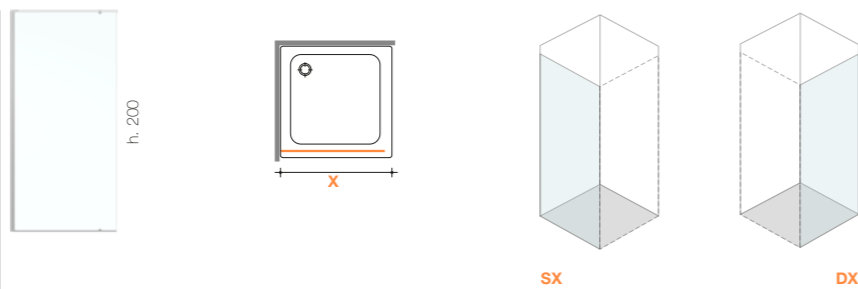

article	boxes	dimension of the installed shower tray <b>X</b>
<b>KF 68÷139</b>	1	Link KF shower enclosure is always custom made (cm by cm).  Ex.: <b>KF 85</b> = shower enclosure for a recess dimension between cm. 85 and 86,5.

**! ATTENTION:** Link shower enclosures are designed to be installed on a standard shower tray. In the case of installation on the floor or on special shower trays that may need a custom size, the installation layout sheet (see pages 338-339 of the general pricelist) must be complete and attached to the order.

link  
KF

glasses

<b>04</b> clear glass	<b>04 + TPA</b> Transparent with TPA			
-----------------------	---	--	--	--

**STANDARD DIMENSIONS**

codes	dimension of shower tray	profiles		
<b>KF 68</b>	68-69,5	<b>21</b> bright silver	<b>748,00</b>	<b>837,00</b>
<b>KF 78</b>	78-79,5	<b>21</b> bright silver	<b>777,00</b>	<b>866,00</b>
<b>KF 88</b>	88-89,5	<b>21</b> bright silver	<b>805,00</b>	<b>894,00</b>

**! ATTENTION**  
the model **KF** in standard dimension can be combined exclusively with an element **KA**.

glasses

<b>04</b> clear glass	<b>05</b> Timeless® anti-corrosion low maintenance glass. NO TPA available	<b>03</b> clear bronze <b>07</b> clear grey	<b>01</b> obscure glass <b>08</b> satin glass <b>11</b> cathedral <b>12</b> extra-light	<b>06</b> reflecting <b>10</b> extra-reflex <b>14</b> satin extra-light <b>29</b> madras nuvola
-----------------------	--	--	--	--

**MADE TO MEASURE**

codes	dimension of shower tray	profiles					
<b>KF 68 ... KF 77</b>	+ 15 mm adjustability on item code measure	<b>31</b>	807,00	910,00	912,00	997,00	1.098,00
		<b>21</b>	814,00	917,00	919,00	1.003,00	1.104,00
		<b>09 - 14 - 39 - 61</b>	884,00	987,00	989,00	1.073,00	1.174,00
<b>KF 78 ... KF 87</b>	+ 15 mm adjustability on item code measure	<b>31</b>	837,00	952,00	957,00	1.058,00	1.168,00
		<b>21</b>	845,00	960,00	965,00	1.066,00	1.175,00
		<b>09 - 14 - 39 - 61</b>	915,00	1.030,00	1.035,00	1.136,00	1.245,00
<b>KF 88 ... KF 97</b>	+ 15 mm adjustability on item code measure	<b>31</b>	868,00	997,00	1.003,00	1.121,00	1.237,00
		<b>21</b>	875,00	1.003,00	1.010,00	1.128,00	1.243,00
		<b>09 - 14 - 39 - 61</b>	946,00	1.074,00	1.081,00	1.199,00	1.314,00
<b>KF 98 ... KF 107</b>	+ 15 mm adjustability on item code measure	<b>31</b>	929,00	1.071,00	1.081,00	1.211,00	1.338,00
		<b>21</b>	935,00	1.077,00	1.087,00	1.217,00	1.343,00
		<b>09 - 14 - 39 - 61</b>	1.012,00	1.154,00	1.164,00	1.294,00	1.421,00
<b>KF 108 ... KF 117 (1)</b>	+ 15 mm adjustability on item code measure	<b>31</b>	1.052,00	1.207,00	1.220,00	1.372,00	1.518,00
		<b>21</b>	1.057,00	1.211,00	1.224,00	1.376,00	1.523,00
		<b>09 - 14 - 39 - 61</b>	1.137,00	1.291,00	1.304,00	1.456,00	1.603,00
<b>KF 118 ... KF 139 (1)</b>	+ 15 mm adjustability on item code measure	<b>31</b>	1.104,00	1.284,00	1.290,00	1.456,00	1.615,00
		<b>21</b>	1.108,00	1.288,00	1.293,00	1.460,00	1.618,00
		<b>09 - 14 - 39 - 61</b>	1.190,00	1.370,00	1.375,00	1.542,00	1.701,00

(1) Attention: Packed in wooden box with no extra costs

**OPTIONS - For customized solutions the additional costs have to be applied on made to measure prices**

Category	Option	Price	Description
Glass	<b>TPA</b>	105,00	from KF 68 to KF 97 - treatment preventing limescale TPA
	<b>TPA</b>	150,00	from KF 98 to KF 139 - treatment preventing limescale TPA
	<b>Screen print</b>	144,00	decors: D50 D51 D52 D54 D55 D60 D61
	<b>Personal Glass</b>	222,00	decors: P56 P70
Profiles	<b>32</b>	+ 20%	on bright silver 21
	<b>15 / 23 / 33 / 38 / 73 / 84</b>	+ 25%	on bright silver 21
	<b>34 / 35 / 54</b>	927,00	on bright silver 21
Special sizes	<b>Lower height</b>	+ 5%	less than cm 200
	<b>Higher height</b>	+ 15%	higher height - max. cm 215
	<b>Higher height</b>	+ 30%	higher height - max. cm 230 - till max KF 119
	<b>Special width</b>	no extra charge	less than cm 68 (min cm 30)

**Product description**

Fixed element for corner or 3 sided shower enclosure.

**Characteristics**

It can be assembled with

KC: **KB - K2 - K3**

KG: **K2 - K3 - KM**

Adjustability **15 mm**, obtained without the extension of the wall profile, which retains its aesthetic.

Extension can be increased by **15 mm** with the additional profile AD15.

Double possibility of adjustment, lateral and longitudinal, after installation, for an easy final regulation before sealing.

S.M.F. (easily mounting system).

Product conforming to EN 14428:2018 with **CE** marking

**Materials**

Tempered safety glass 8 mm.

Anodised or enamelled aluminium.



**Technical specifications**

Please, always specify if left **SX** or right **DX** opening.

Please, always advise the exact dimensions of the installed shower tray.

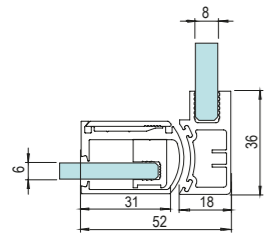

The fixed element **KC** must be used to combine a door to a fix element in a corner.

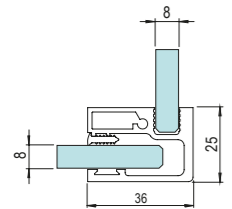

The fixed element **KG** must be used to combine two fixed panels in a corner.

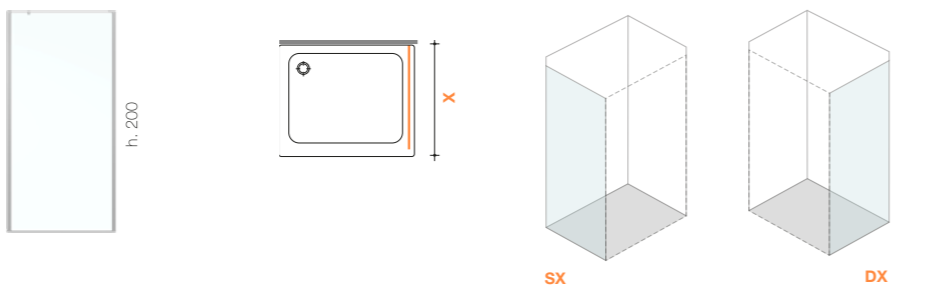

article	boxes	dimension of the installed shower tray X	
<b>KG 68+139</b> <b>KC 68+139</b>	1	Link KG and KC shower enclosure are always custom made (cm by cm).	Ex.: <b>KG 85</b> = shower enclosure for a recess dimension between cm. 85 and 86,5.

**ATTENTION:** Link shower enclosures are designed to be installed on a standard shower tray. In the case of installation on the floor or on special shower trays that may need a custom size, the installation layout sheet (see pages 338-339 of the general pricelist) must be complete and attached to the order.

link  
KG

glasses

<b>04</b> clear glass	<b>05</b> Timeless® anti-corrosion low maintenance glass. NO TPA available	<b>03</b> clear bronze	<b>01</b> obscure glass	<b>06</b> reflecting
		<b>07</b> clear grey	<b>08</b> satin glass	<b>10</b> extra-reflex
			<b>11</b> cathedral	<b>14</b> satin extra-light
			<b>12</b> extra-light	<b>29</b> madras nuvola

**MADE TO MEASURE**

codes	dimension of shower tray	profiles					
<b>KG 68 ... KC 77</b> <b>KG 68 ... KG 77</b>	+ 15 mm adjustability on item code measure	<b>31</b>	908,00	1.011,00	1.016,00	1.109,00	1.225,00
		<b>21</b>	914,00	1.017,00	1.021,00	1.114,00	1.231,00
		<b>09 - 14 - 39 - 61</b>	999,00	1.102,00	1.107,00	1.200,00	1.316,00
<b>KG 78 ... KC 87</b> <b>KG 78 ... KG 87</b>	+ 15 mm adjustability on item code measure	<b>31</b>	947,00	1.062,00	1.067,00	1.183,00	1.308,00
		<b>21</b>	952,00	1.068,00	1.072,00	1.189,00	1.313,00
		<b>09 - 14 - 39 - 61</b>	1.039,00	1.154,00	1.159,00	1.275,00	1.400,00
<b>KC 88 ... KC 97</b> <b>KG 88 ... KG 97</b>	+ 15 mm adjustability on item code measure	<b>31</b>	987,00	1.116,00	1.121,00	1.257,00	1.391,00
		<b>21</b>	991,00	1.120,00	1.126,00	1.261,00	1.395,00
		<b>09 - 14 - 39 - 61</b>	1.079,00	1.208,00	1.213,00	1.349,00	1.483,00
<b>KC 98 ... KC 107</b> <b>KG 98 ... KG 107</b> <b>(1)</b>	+ 15 mm adjustability on item code measure	<b>31</b>	1.026,00	1.168,00	1.172,00	1.331,00	1.475,00
		<b>21</b>	1.030,00	1.172,00	1.177,00	1.335,00	1.480,00
		<b>09 - 14 - 39 - 61</b>	1.119,00	1.261,00	1.265,00	1.424,00	1.568,00
<b>KC 108 ... KC 117</b> <b>KG 108 ... KG 117</b> <b>(1) (2)</b>	+ 15 mm adjustability on item code measure	<b>31</b>	1.136,00	1.290,00	1.298,00	1.477,00	1.642,00
		<b>21</b>	1.143,00	1.298,00	1.305,00	1.485,00	1.649,00
		<b>09 - 14 - 39 - 61</b>	1.243,00	1.397,00	1.405,00	1.585,00	1.749,00
<b>KC 118 ... KC 139</b> <b>KG 118 ... KG 139</b> <b>(1) (2)</b>	+ 15 mm adjustability on item code measure	<b>31</b>	1.180,00	1.360,00	1.359,00	1.558,00	1.737,00
		<b>21</b>	1.187,00	1.366,00	1.365,00	1.565,00	1.744,00
		<b>09 - 14 - 39 - 61</b>	1.288,00	1.467,00	1.466,00	1.666,00	1.845,00

**(1) Attention:** It can only be used in corner shower configurations. It cannot be used in 3-sided configurations.

**(2) Attention:** Packed in wooden box with no extra costs

**OPTIONS - For customized solutions the additional costs have to be applied on made to measure prices**

Options	Additional costs	Notes
<b>Glass</b>	<b>TPA</b>	105,00 from 68 to 97 - treatment preventing limescale TPA
	<b>TPA</b>	150,00 from 98 to 139 - treatment preventing limescale TPA
	<b>Screen print</b>	144,00 decors: D50 D51 D52 D54 D55 D60 D61
	<b>Personal Glass</b>	222,00 decors: P56 P70
<b>Profiles</b>	<b>32</b>	+ 20% on bright silver 21
	<b>15 / 23 / 33 / 38 / 73 / 84</b>	+ 25% on bright silver 21
	<b>34 / 35 / 54</b>	1.393,00 on bright silver 21
<b>Special sizes</b>	<b>Lower height</b>	+ 5% less than cm 200
	<b>Higher height</b>	+ 15% higher height - max. cm 215
	<b>Higher height</b>	+ 30% higher height - max. cm 230 - till max 99
	<b>Special width</b>	no extra charge less than cm 68 (min cm 50)

**Product description**

Fixed panel KP for installations on a bath tub or on a low wall.

**Characteristics**

Extensible 15 mm.

To be assembled with elements

**KN - KB - K2 - KZ - K3 - KM**

Horizontal adjustment.

Product conforming to EN 14428:2018 with CE marking.

**Materials**

Tempered safety glass 8 mm.

Anodised or enamelled aluminium profiles.



**Technical specifications**

The KP panel is always custom made. Please advise the correct dimensions (width and height) and specify if left SX or right DX to the door.

Please always attach to the order sheet the technical drawing (from page 340 to page 343 of the general pricelist)

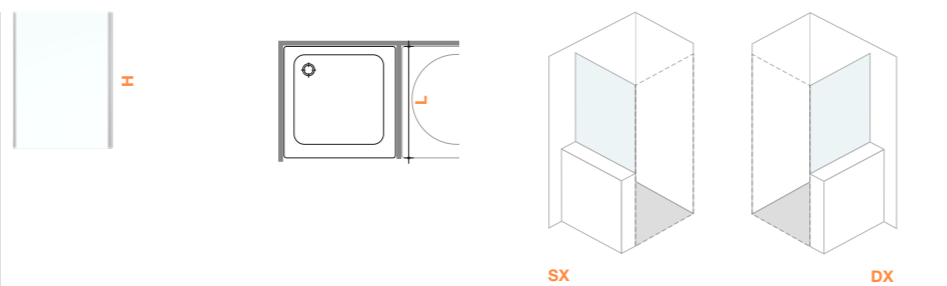

article	boxes	dimensions L	dimensions H
KP 140	1	from 60 to 100	from 100 to 170

link  
KP

glasses

<b>04</b> clear glass	<b>05</b> Timeless® anti-corrosion low maintenance glass. NO TPA available	<b>03</b> clear bronze	<b>01</b> obscure glass	<b>06</b> reflecting
		<b>07</b> clear grey	<b>08</b> satin glass	<b>10</b> extra-reflex
			<b>11</b> cathedral	<b>14</b> satin extra-light
			<b>12</b> extra-light	<b>29</b> madras nuvola

**MADE TO MEASURE**

codes	dimensions	profiles					
<b>KP 140</b>	+ 15 mm adjustability on item code measure	<b>31</b>	814,00	910,00	929,00	1.029,00	1.129,00
		<b>21</b>	855,00	951,00	973,00	1.070,00	1.171,00
		<b>09 - 14 - 39 - 61</b>	945,00	1.041,00	1.067,00	1.163,00	1.267,00

**OPTIONS - For customized solutions the additional costs have to be applied on made to measure prices**

<b>Glass</b>	<b>TPA</b>	89,00	treatment preventing limescale TPA
	<b>Screen print</b>	133,00	decors: D50 D51 D52 D54 D55 D60 D61
	<b>Personal Glass</b>	200,00	decors: P56 P70
<b>Profiles</b>	<b>32</b>	+ 20%	on bright silver 21
	<b>15 / 23 / 33 / 38 / 73 / 84</b>	+ 25%	on bright silver 21
	<b>34 / 35 / 54</b>	927,00	on bright silver 21
<b>Special sizes</b>			

# supersintesi

collection



# supersintesi

**Supersintesi** is the new Vismaravetro program for a shower enclosure with hinged door. High functionality beyond the rigorous design and the aesthetic research. All components of Supersintesi are finish treated and they are miniaturized to enhance the glass surfaces. The magnetic seals are applied to the aluminium profiles along the glass section: minimal dimensions and elegance.



The wall must be perpendicular to the door and the fixing base not less than 50 mm.

The installation system needs a free space of 10/12 cm above the shower enclosure to operate with a screw-driver.

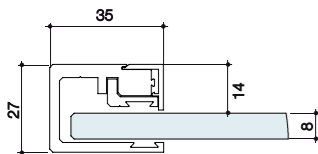

hinge



handle



profile top cover



magnetic seal



baloon gasket



SMF profile

The complete range of Vismaravetro profiles is available upon request at the e-mail [info@vismaravetro.it](mailto:info@vismaravetro.it)

supersintesi  
type

recess

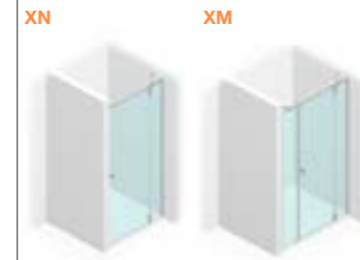

corner

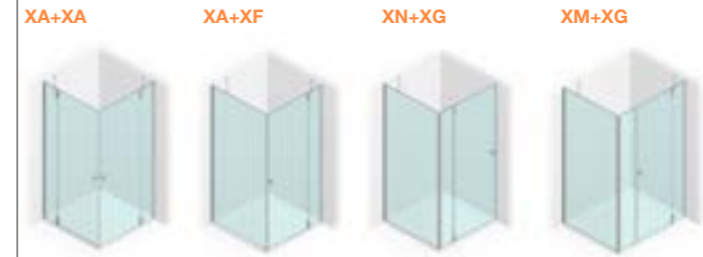

quadrant /  
pentagonal

3-sided

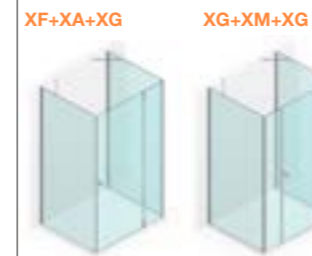

side panel

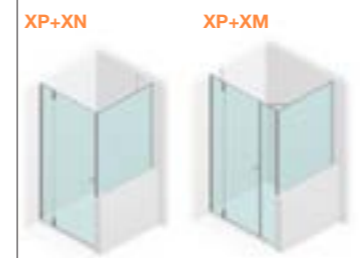

Custom  
solutions

The collection Supersintesi fits to special configurations and bespoke solutions (such as special cuttings for small walls or underroof, models for people with reduced mobility, hotel or residential contracts, solutions for shipbuilding). Please send your enquiry to our technical office at [info@vismaravetro.it](mailto:info@vismaravetro.it)

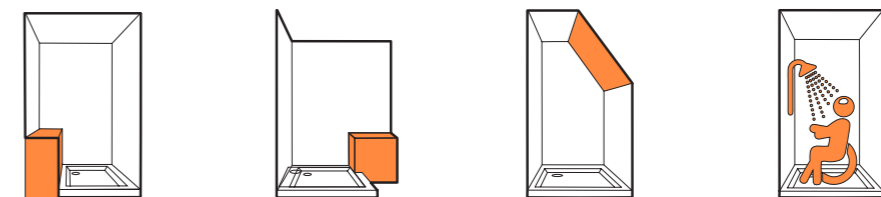

These examples are just indicative. Being customized solutions, it is necessary to submit an enquiry to our Technical Department so to check the feasibility and get an indication of the price.











**Product description**

Fixed panel XP for installations on a bath tub or on a low wall.

**Characteristics**

- Adjustability **20** mm.
- Double possibility of adjustment, lateral and longitudinal.
- To be assembled with door XN XM.
- Product conforming to EN 14428:2018 with **CE** marking.

**Materials**

- Tempered glass 8 mm.
- Anodised or enamelled aluminium profiles.



**Technical specifications**

The SP panel is always custom made. Please advise the correct dimensions (width and height) and specify if left **SX** or right **DX** to the door.

Please always attach to the order sheet the technical drawing (from page 340 to page 343).

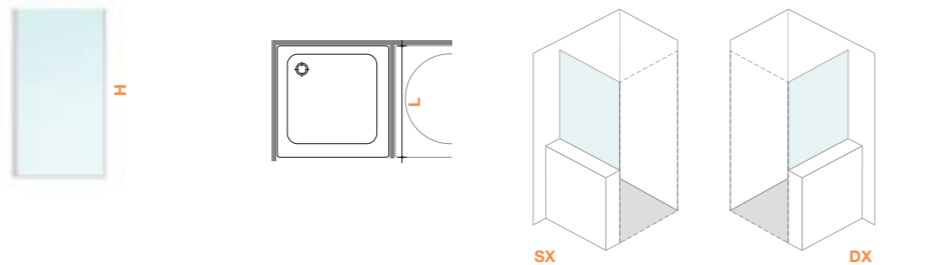

article	boxes	dimension L	dimension H
serie Supersintesi <b>XP 140</b>	1	from 60 to 100	from 100 to 170

supersintesi  
**XP**

glasses

<b>04</b> clear glass	<b>05</b> Timeless® anti-corrosion low maintenance glass. NO TPA available	<b>03</b> clear bronze	<b>01</b> obscure glass	<b>06</b> reflecting
		<b>07</b> clear grey	<b>08</b> satin glass	<b>10</b> extra-reflex
			<b>11</b> cathedral	<b>14</b> satin extra-light
			<b>12</b> extra-light	<b>29</b> madras nuvola

**MADE TO MEASURE**

codes	dimensions	profiles					
<b>XP 140</b>	+ 15 mm adjustability on item code measure	<b>31</b>	780,00	877,00	896,00	996,00	1.096,00
		<b>21</b>	821,00	918,00	940,00	1.037,00	1.138,00
		<b>09 - 14 - 39 - 61</b>	911,00	1.008,00	1.033,00	1.130,00	1.233,00

**OPTIONS**

<b>Glass</b>	<b>TPA</b>	89,00	treatment preventing limescale TPA
	<b>Screen print</b>	133,00	decors: D50 D51 D52 D54 D55 D60 D61
	<b>Personal Glass</b>	200,00	decors: P19 P32 P70
<b>Profiles</b>	<b>32</b>	+ 20%	on bright silver 21
	<b>15 / 23 / 33 / 38 / 73 / 84</b>	+ 25%	on bright silver 21
<b>Special sizes</b>			

**Custom solutions**

By connecting to the web page shown below, via QR code or by typing the address into your computer browser, you can get information on the custom solutions available for this model and the related additional costs. The examples are just indicative. Being customized solutions, it is necessary to submit an enquiry to our Technical Department so to check the feasibility and get an indication of the price.



vism.it/LS/LSXP.pdf

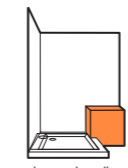

shaped wall

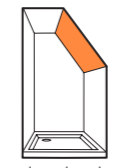

sloped or shape ceiling

# flare 2.0

collection



# flare 2.0

Making innovations on a hinged door shower enclosure is a major challenge. The elements that constitute it, the hinges, glass panel and handle, are the basis of the door's archetype. The simplicity of movement, the immediate intuitiveness of its function and aesthetic neat lines are enhanced. We have succeeded with Vismaravetro and achieved all our objectives with Flare 2.0, including the usual and indispensable attention to water tightness, performance, user safety and ease of installation. This is an evolution inspired by tradition which develops into a new state of the art expression.



The wall must be perpendicular to the door and the fixing base not less than 50 mm.

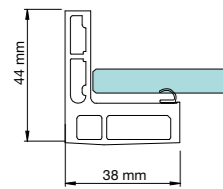

Wall profile on door elements

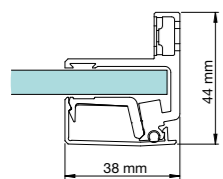

Wall profile on fixed elements

The complete range of Vismaravetro profiles is available upon request at the e-mail [info@vismaravetro.it](mailto:info@vismaravetro.it)



Flare 2.0 series requires a solid anchor and resistant wall. In case of different solutions (presence of non-masonry walls, wooden panels, sliding doors, plasterboard, ventilated walls, ...) it is advisable to evaluate the strength of the wall in the design phase and adopt any suitable reinforcement interventions



magnetic seals



SMF profile



Flare 2.0 handle M11F  
dimensions: 33,4 cm



Flare 2.0 hinge  
made of aluminium, it allows the door to open 180°. It comes with a door stop function at 90°.



The internal part of the hinge is always in the same finish of the aluminum profiles.

flare 2.0  
type

recess

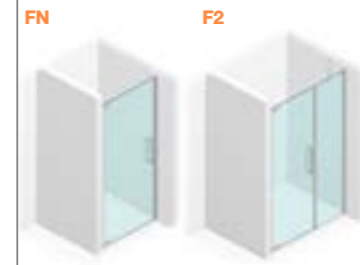

corner

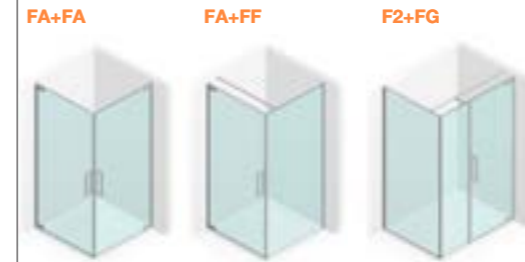

quadrant

3-sided

side panel



FP element is equal to SP of Sintesi collection. See page 194/195 for information and prices.

Custom solutions

The collection Flare 2.0 fits to special configurations and bespoke solutions (such as special cuttings for small walls or underroof, models for people with reduced mobility, hotel or residential contracts) Please send your enquiry to our technical office at [info@vismaravetro.it](mailto:info@vismaravetro.it)

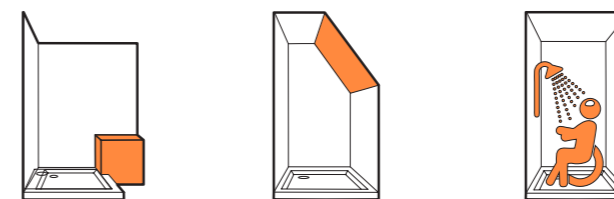

These examples are just indicative. Being customized solutions, it is necessary to submit an enquiry to our Technical Department so to check the feasibility and get an indication of the price.

**Product description**

Framless shower enclosure with pivoting adjustable hinges for recess.

**Characteristics**

Adjustability **25** mm, obtained without the extension of the wall profile, which retains its aesthetic.

Double possibility of adjustment, lateral and longitudinal, upon completion of the installation, for an easy final adjustment before sealing.

Magnetic strips.  
Items in matt black **09** finishing are equipped with black seals.

Outward opening only.

**S.M.F.**  
(easily mounting system)

Product conforming to EN 14428:2018 with marking.

**Materials**

Tempered safety glass 8 mm.

Anodised aluminium profiles.



**Technical specifications**

Please, always advise the exact dimensions of the recess **X**

Please always specify if left **SX** or right **DX** opening.

\* Due to technical reasons, the height of the profile with the hinges is 5 mm lower than the overall height of the shower enclosure..

**ATTENTION:** Flare 2.0 FN door requires a solid anchor and resistant wall. In case of different solutions (presence of non-masonry walls, wooden panels, sliding doors, plasterboard, ventilated walls, ...) it is advisable to evaluate the strength of the wall in the design phase and adopt any suitable reinforcement interventions. The feasibility of any special attack, must be submitted to our technical office.

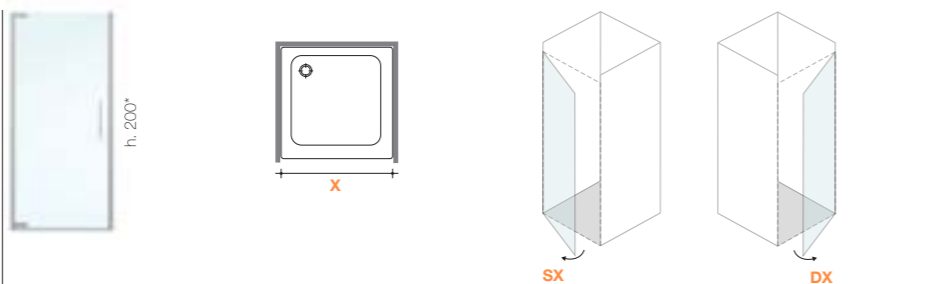

article	boxes	dimension of recess X	opening cm
FN 68÷99	1	Flare "FN" shower enclosure is always custom made (cm by cm).  Ex.: FN 78 = shower enclosure for a recess dimension between cm. 78 and 80,5.	The door has an outer overall dimension of approximately 18 cm less than the recess, which corresponds to the opening. The pivot is at a fixed distance of 14,5 cm from the wall.  Ex: recess 90 cm: opening 72 cm

**Important:** Flare 2.0 shower enclosures are designed to be installed on a standard shower tray. In the case of installation on the floor or on special shower trays that may need a custom size, the installation layout sheet must be complete and attached to the order (see pages 338-339)

flare 2.0  
FN

glasses	04 clear glass	04 + TPA Transparent with TPA (virgola included)			
---------	----------------	---	--	--	--

**STANDARD DIMENSIONS**

codes	dimension of recess	profiles		
FN 68	68-70,5	21 bright silver	1.169,00	1.286,00
FN 78	78-80,5	21 bright silver	1.214,00	1.331,00
FN 88	88-90,5	21 bright silver	1.258,00	1.375,00

**! ATTENTION**  
The model FN in standard dimension cannot be combined with other elements.

glasses	04 clear glass	05 Timeless® anti-corrosion low maintenance glass. NO TPA available	03 clear bronze 07 clear grey	01 obscure glass 08 satin glass 11 kathedral 12 extra-light	06 reflecting 10 extra-reflex 14 satin extra-light 29 madras nuvola
---------	----------------	---	----------------------------------	--	--

**MADE TO MEASURE**

codes	dimension of recess	profiles					
FN 68 ... FN 77	Adjustability on item code measure +25 mm	21 - 31	1.271,00	1.364,00	1.395,00	1.484,00	1.632,00
		09 - 61	1.411,00	1.504,00	1.523,00	1.612,00	1.760,00
		32	1.666,00	1.759,00	1.779,00	1.868,00	2.016,00
FN 78 ... FN 87	Adjustability on item code measure +25 mm	21 - 31	1.320,00	1.425,00	1.456,00	1.566,00	1.724,00
		09 - 61	1.465,00	1.571,00	1.591,00	1.701,00	1.858,00
		32	1.732,00	1.837,00	1.857,00	1.967,00	2.125,00
FN 88 ... FN 99	Adjustability on item code measure +25 mm	21 - 31	1.368,00	1.489,00	1.520,00	1.648,00	1.813,00
		09 - 61	1.516,00	1.637,00	1.657,00	1.786,00	1.950,00
		32	1.793,00	1.914,00	1.935,00	2.062,00	2.227,00

**OPTIONS - For customized solutions the additional costs have to be applied on made to measure prices**

Glass	TPA	133,00	treatment preventing limescale TPA Virgola included
	Screen print	144,00	decors: D50 D51 D52 D54 D55 D60 D61
	Personal Glass	222,00	decors: P13 P15 P16 P19 P56 P70

Profiles			
Special sizes	Lower height	+ 5%	less than cm 200
	Higher height	+ 15%	higher height - max. cm 215
		+ 30%	higher height - max. cm 230 - till max FN 82
	Special width	no extra charge	less than cm 68 (min. cm 60)

**Custom solutions** By connecting to the web page shown below, via QR code or by typing the address into your computer browser, you can get information on the custom solutions available for this model and the related additional costs. The examples are just indicative. Being customized solutions, it is necessary to submit an enquiry to our Technical Department so to check the feasibility and get an indication of the price.



[vism.it/LS/LSFN.pdf](http://vism.it/LS/LSFN.pdf)



sloped or shape ceiling only closure side



**Product description**

Frameless shower door with pivoting adjustable hinges.  
It can be assembled with another door FA or with a fixed element FF to obtain a corner shower enclosure.

**Characteristics**

Adjustability **15 mm**, obtained without the extension of the wall profile, which retains its aesthetic.

Double possibility of adjustment, lateral and longitudinal, upon completion of the installation, for an easy final adjustment before sealing.

Magnetic strips.  
Items in matt black **09** finishing are equipped with black seals.

Outward opening only.

**S.M.F.**  
(easily mounting system)

Product conforming to EN 14428:2018 with **CE** marking

**Materials**

Tempered safety glass 8 mm.  
Anodised aluminium profiles.



**Technical specifications**

Please, always advise the exact dimensions of the installed shower tray and specify if left **SX** or right **DX** opening.

\* Due to technical reasons, the height of the profile with the hinges is 5 mm lower than the overall height of the shower enclosure.

**ATTENTION:** Flare 2.0 FA door requires a solid anchor and resistant wall. In case of different solutions (presence of non-masonry walls, wooden panels, sliding doors, plasterboard, ventilated walls, ...) it is advisable to evaluate the strength of the wall in the design phase and adopt any suitable reinforcement interventions. The feasibility of any special attack , must be submitted to our technical office.

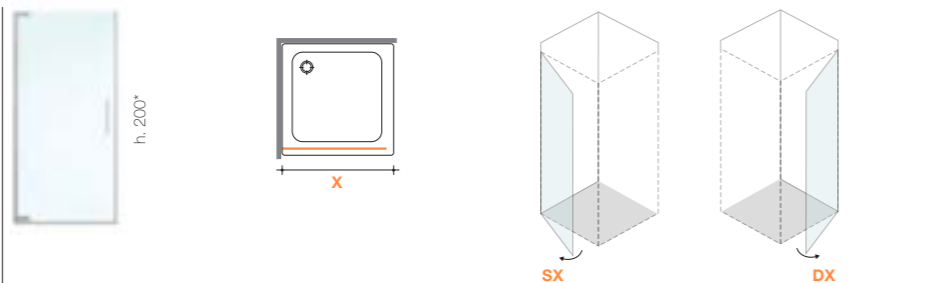

article	boxes	dimension of the installed shower tray X	opening cm
FA 68÷99	1	Flare "FA" shower enclosure is always custom made (cm by cm).  Ex.: FA 88 = shower enclosure for a recess dimension between cm. 88 and 89,5.	The door has an outer overall dimension of approximately 15 cm less than the recess, which corresponds to the opening. The pivot is at a fixed distance of 14,5 cm from the wall.  Ex: shower tray 90 cm: opening 75 cm

**Important:** Flare 2.0 shower enclosures are designed to be installed on a standard shower tray. In the case of installation on the floor or on special shower trays that may need a custom size, the installation layout sheet must be complete and attached to the order (see pages 338-339)

flare 2.0  
FA

**STANDARD DIMENSIONS**

codes	dimension of shower tray	profiles	glasses	
FA 68	68-69,5	21 bright silver	04 clear glass	04 + TPA Transparent with TPA (virgola included)
FA 78	78-79,5	21 bright silver		
FA 88	88-89,5	21 bright silver		

**ATTENTION**  
The model FA in standard dimension can be combined exclusively with an element FF or to another element FA.

Quick delivery items.

**MADE TO MEASURE**

codes	dimension of shower tray	profiles	glasses				
FA 68 ... FA 77	Adjustability on item code measure +15 mm	21 - 31	1.117,00	1.210,00	1.233,00	1.324,00	1.456,00
		09 - 61	1.239,00	1.332,00	1.346,00	1.437,00	1.571,00
		32	1.464,00	1.557,00	1.572,00	1.663,00	1.794,00
FA 78 ... FA 87	Adjustability on item code measure +15 mm	21 - 31	1.168,00	1.273,00	1.298,00	1.406,00	1.546,00
		09 - 61	1.295,00	1.401,00	1.415,00	1.525,00	1.665,00
		32	1.532,00	1.637,00	1.651,00	1.760,00	1.900,00
FA 88 ... FA 99	Adjustability on item code measure +15 mm	21 - 31	1.214,00	1.335,00	1.361,00	1.492,00	1.638,00
		09 - 61	1.348,00	1.469,00	1.483,00	1.613,00	1.760,00
		32	1.593,00	1.714,00	1.728,00	1.859,00	2.006,00

**OPTIONS - For customized solutions the additional costs have to be applied on made to measure prices**

<b>Glass</b>	TPA	133,00	treatment preventing limescale TPA Virgola included
	Screen print	144,00	decors: D50 D51 D52 D54 D55 D60 D61
	Personal Glass	222,00	decors: P13 P15 P16 P19 P56 P70
<b>Profiles</b>			
<b>Special sizes</b>	Lower height	+ 5%	less than cm 200
	Higher height	+ 15%	higher height - max. cm 215
		+ 30%	higher height - max. cm 230 - till max FA 82
<b>Special width</b>		no extra charge	less than cm 68 (min. cm 60)

**Custom solutions** By connecting to the web page shown below, via QR code or by typing the address into your computer browser, you can get information on the custom solutions available for this model and the related additional costs. The examples are just indicative. Being customized solutions, it is necessary to submit an enquiry to our Technical Department so to check the feasibility and get an indication of the price.



[vism.it/LS/LSFA.pdf](http://vism.it/LS/LSFA.pdf)

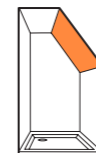

sloped or shape ceiling only closure side



shower element compatible with the need of people with reduced mobility



**Descrizione prodotto**

Fixed panel that connected with element F2 composes a shower enclosure for shower trays in corner.

**Characteristics**

It can be combined exclusively with an element F2.

When F2 is used in a corner solution with the element FG, F2 must be installed with the door fixed to the wall side and its adjustability is reduced to 20 mm.

Adjustability **20** mm, obtained without the extension of the wall profile, which retains its aesthetic.

Double possibility of adjustment, lateral and longitudinal, upon completion of the installation, for an easy final adjustment before sealing.

**S.M.F.**

(easily mounting system)

Product conforming to EN14428:2018 with **CE** marking.

**Materials**

Tempered safety glass 8 mm.

Anodised aluminium profiles.



**Technical specifications**

Please, always advise the exact dimensions of the installed shower tray and specify if left **SX** or right **DX**.

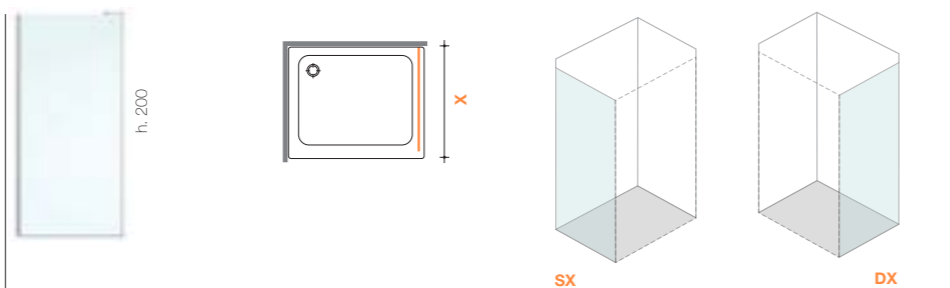

article	boxes	dimension of the installed shower tray X	
<b>FG 68÷119</b>	1	Flare "FG" fixed panel is always custom made (cm by cm).	Ex.: <b>FG 88</b> = shower enclosure for a recess dimension between cm. 88 and 90.



**Important: new dimensions!**

**Important:** Flare 2.0 shower enclosures are designed to be installed on a standard shower tray. In the case of installation on the floor or on special shower trays that may need a custom size, the installation layout sheet must be complete and attached to the order (see pages 338-339)

flare 2.0  
FG

glasses

<b>04</b> clear glass	<b>05</b> Timeless® anti-corrosion low maintenance glass. NO TPA available	<b>03</b> clear bronze	<b>01</b> obscure glass	<b>06</b> reflecting
		<b>07</b> clear grey	<b>08</b> satin glass	<b>10</b> extra-reflex
			<b>11</b> cathedral	<b>14</b> satin extra-light
			<b>12</b> extra-light	<b>29</b> madras nuvola

**MADE TO MEASURE**

codes	dimension of shower tray	profiles					
<b>FG 68 ... FG 77 (1)</b>	Adjustability on item code measure +20 mm	<b>21 - 31</b>	677,00	770,00	781,00	869,00	957,00
		<b>09 - 61</b>	751,00	845,00	851,00	939,00	1.026,00
		<b>32</b>	889,00	982,00	989,00	1.080,00	1.168,00
<b>FG 78 ... FG 87 (1)</b>	Adjustability on item code measure +20 mm	<b>21 - 31</b>	722,00	827,00	839,00	951,00	1.046,00
		<b>09 - 61</b>	801,00	907,00	915,00	1.026,00	1.121,00
		<b>32</b>	949,00	1.055,00	1.064,00	1.174,00	1.270,00
<b>FG 88 ... FG 97 (1)</b>	Adjustability on item code measure +20 mm	<b>21 - 31</b>	768,00	887,00	900,00	1.030,00	1.133,00
		<b>09 - 61</b>	854,00	972,00	980,00	1.109,00	1.214,00
		<b>32</b>	1.007,00	1.126,00	1.139,00	1.268,00	1.371,00
<b>FG 98 ... FG 107 (1)</b>	Adjustability on item code measure +20 mm	<b>21 - 31</b>	846,00	977,00	989,00	1.133,00	1.247,00
		<b>09 - 61</b>	938,00	1.069,00	1.079,00	1.220,00	1.334,00
		<b>32</b>	1.108,00	1.239,00	1.250,00	1.394,00	1.508,00
<b>FG 108 ... FG 119 (1) (2)</b>	Adjustability on item code measure +20 mm	<b>21 - 31</b>	920,00	1.067,00	1.081,00	1.235,00	1.361,00
		<b>09 - 61</b>	1.021,00	1.168,00	1.174,00	1.332,00	1.456,00
		<b>32</b>	1.208,00	1.354,00	1.364,00	1.521,00	1.646,00

(1) A fixing bracket "Q" is supplied with the combined item F2.  
FG packaging contains the component to use for "glass-glass" configuration.  
When possible, instead of the bracket "Q", we recommend the use of "R + J" stabiliser rod - to specifically require and order separately.  
**2) Attention:** Packed in wooden box without extra costs

**OPTIONS - For customized solutions the additional costs have to be applied on made to measure prices**

<b>External towel holder</b>		<b>PST - PSR</b>	see page 326 for informations and prices
<b>Glass</b>	<b>TPA</b>	105,00	from FG 68 to FG 97 - treatment preventing limescale TPA
	<b>TPA</b>	150,00	from FG 98 to FG 119 - treatment preventing limescale TPA
	<b>Screen print</b>	144,00	decors: D50 D51 D52 D54 D55 D60 D61
	<b>Personal Glass</b>	222,00	decors: P13 P15 P16 P19 P56 P70
<b>Profiles</b>			
<b>Special sizes</b>	<b>Lower height</b>	+ 5%	less than cm 200
	<b>Higher height</b>	+ 15%	higher height - max. cm 215
		+ 30%	higher height - max. cm 230
	<b>Special width</b>	no extra charge	less than cm 68 (min. cm 30)

**Custom solutions**

By connecting to the web page shown below, via QR code or by typing the address into your computer browser, you can get information on the custom solutions available for this model and the related additional costs.  
The examples are just indicative. Being customized solutions, it is necessary to submit an enquiry to our Technical Department so to check the feasibility and get an indication of the price.



[vism.it/LS/L/SFG.pdf](http://vism.it/LS/L/SFG.pdf)



shaped wall

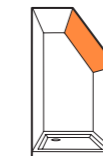

sloped or shape ceiling

# serie F

collection



# serie F

**Serie F** is a collection of shower enclosures that evokes the origins of this sector, when shower enclosures were essentially only formed by glass and hinges on the wall, but at the same time it encapsulates over 70 years of experience in the sector. We are rather proud of this collection: they are unique shower enclosures in the true sense of the word, because they are custom-made to the millimetre, designed to meet needs, dreams and desires which go beyond the ordinary.



## Glass to the millimetre

All elements of the Serie F Collection are made to measure to the millimetre. We create unique pieces to perfectly meet the dimensional requirements of each individual shower recess. Heights greater than 210 cm or widths greater than 90 cm will require a third hinge. Use the QRcode given here to download the chart to determine the maximum size of the door (max. height 300 cm), or use the dedicated algorithm for a quick answer.

Brass hinges with inward and outward opening. The door is held in the central (closed) position by a spring mechanism, which offers  $\pm 10^\circ$  adjustment.



[www.vism.it/cmm](http://www.vism.it/cmm)  
Find the maximum dimensions of your door

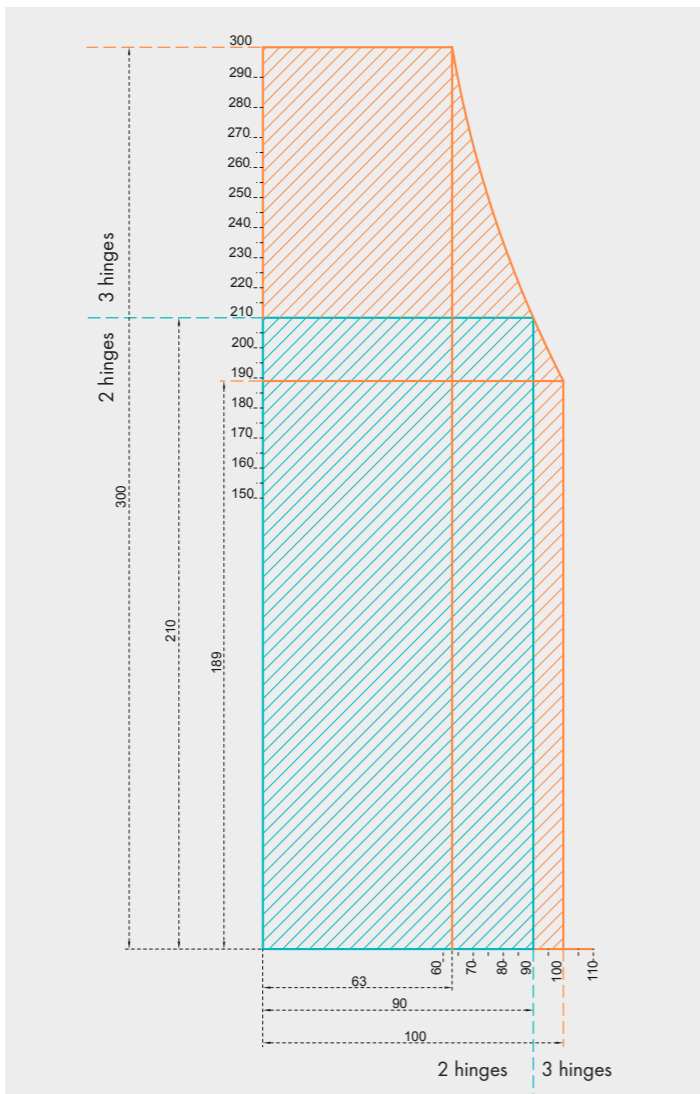

hinge

flare type

recess

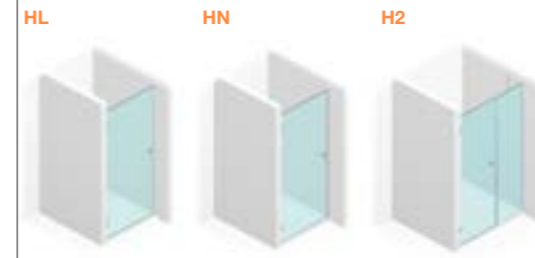

corner

quadrant

3-sided

side panel

Custom solutions

# handles

Zamak alloy handles.  
The handle finish always matches  
the rest of the metal parts.

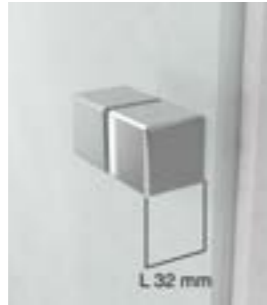

**Code P3Q**  
Square zamak alloy knob with  
grip recess.  
This is the standard solution  
unless otherwise specified at  
the time of ordering.  
Dimensions: L 32 mm



**Code P3T**  
Round zamak alloy knob  
with grip recess.  
Dimensions: Ø 34 mm



**Code P0T**  
Solution without handle.  
A hole is drilled in the glass and  
the edge polished to provide  
a secure grip with a clean,  
minimalist look.  
Dimensions: hole Ø 50 mm  
Note: potential water leak  
through the hole.



**Code M11F**  
Bar handle.  
Requires two holes in the glass.  
Dimensions: H 334 mm  
Extra charge: 33,00 €

# SIS™

Simple Installation System  
SIS is a system which simplifies  
the installation of Serie F Collection  
doors.  
This door type normally requires great  
care when drilling the walls, as if this is  
not done perfectly, it can compromise  
the entire shower installation.  
A special high-density polystyrene  
template makes installation quick and  
easy



[www.vism.it/sis](http://www.vism.it/sis)  
Watch the tutorial



It is recommended to install the  
door on the most internal edge  
of the shower tray. Use of the  
additional water-stop profile,  
although not mandatory, is highly  
recommended in order to achieve a  
good watertight.

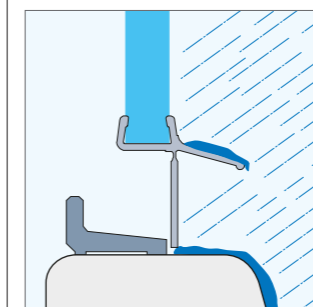

**EXCELLENT**  
watertight

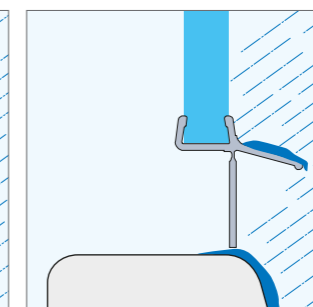

**GOOD**  
watertight

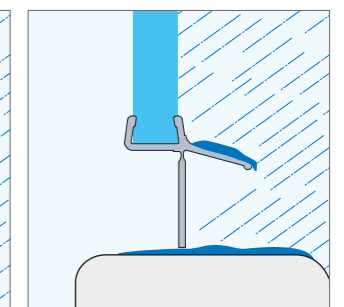

**ACCEPTABLE**  
watertight

**Product description**

Hinged door for recess shower enclosure

**Characteristics**

Made to measure to millimetre precision

No adjustment is possible

The walls of the recess must be of masonry construction and perfectly plumb

Brass hinges with inward and outward opening

Balloon gasket which provides a seal by compressing against the recess wall.

Items in matt black **09**, moka **38** or metal gun **39** finishing are equipped with black seals.

An additional water-stop profile is supplied in the package, which can be used on the edge of the shower tray in order to achieve the best seal.

Maximum heights of up to 300 cm can be achieved with the addition of a third hinge. (see chart on page 088)

SIS™ Simple Installation System.

**Materials**

Tempered glass 8 mm.

Brass hinges

Anodised or enamelled aluminium profiles.



**Technical specifications**

The height of the element HL is always custom made. Prices refer to height between 1700 and 2100 mm.

If a specific height is not given, the element is supplied 2000 mm high.

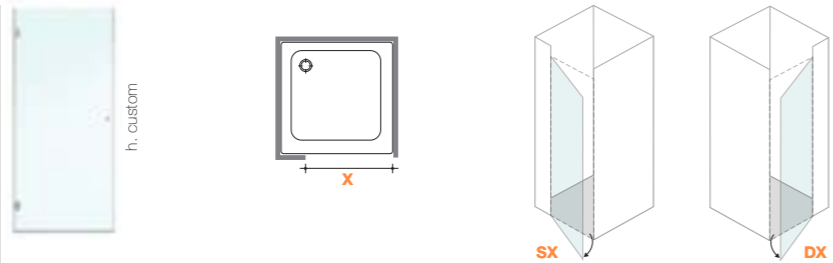

article	boxes	recess dimension X
<b>HL 550÷900</b>	1	Serie F "HL" is always custom made (mm by mm).  No adjustments are possible

serie F  
HL

glasses

**04** clear glass

**05** Timeless® anti-corrosion low maintenance glass. NO TPA available

**03** clear bronze  
**07** clear grey

**01** obscure glass

**08** satin glass

**11** cathedral

**12** extra-light

**06** reflecting

**10** extra-reflex

**14** satin extra-light

**29** madras nuvola

**MADE TO MEASURE to the mm**

codici	shower door	hinges and accessories					
<b>width</b>	from 550 to 700 mm	<b>21 31</b>	1.227,00	1.316,00	1.379,00	1.465,00	1.604,00
<b>height</b>	from 1700 to 2100 mm	<b>09 14 15 39 61</b>	1.295,00	1.385,00	1.451,00	1.536,00	1.677,00
		<b>23 32 33 38 52 73 84</b>	1.490,00	1.580,00	1.600,00	1.685,00	1.826,00
		<b>34 35 54</b>	1.707,00	1.797,00	1.833,00	1.920,00	2.060,00
<b>width</b>	from 701 to 900 mm	<b>21 31</b>	1.293,00	1.409,00	1.475,00	1.610,00	1.754,00
<b>height</b>	from 1700 to 2100 mm	<b>09 14 15 39 61</b>	1.364,00	1.480,00	1.547,00	1.682,00	1.826,00
		<b>23 32 33 38 52 73 84</b>	1.558,00	1.674,00	1.696,00	1.832,00	1.975,00
		<b>34 35 54</b>	1.774,00	1.889,00	1.933,00	2.068,00	2.212,00

**OPTIONS**

<b>Glass</b>	<b>TPA</b>	133,00	TPA anti-limescale treatment with Virgola included
	<b>Screen printing</b>	144,00	decors: D50 D51 D52 D54 D55 D60 D61
	<b>Personal Glass</b>	222,00	decors: P13 P15 P16 P19 P30 D56 D70
<b>Knob</b>	<b>P3Q</b>		standard knob
	<b>P3T - P0T</b>		no extra charge
	<b>M11F</b>	33,00	
<b>Special sizes</b>	see chart on page 088 for feasibility	+ 20%	special sizes may require a third hinge

**Product description**

Hinged door with closing wall profile for recess shower enclosure

**Characteristics**

Made to measure to millimetre precision

Wall profile on closing side to provide 10 mm of adjustment.

The walls of the recess must be of masonry construction and perfectly plumb

Brass hinges with inward and outward opening

Balloon gasket which provides a seal by compressing against the closing wall profile.

Items in matt black **09**, moka **38** or metal gun **39** finishing are equipped with black seals.

An additional water-stop profile is supplied in the package, which can be used on the edge of the shower tray in order to achieve the best seal.

Maximum heights of up to 300 cm can be achieved with the addition of a third hinge. (see chart on page 088)

SIS™ Simple Installation System.

**Materials**

Tempered glass 8 mm.

Brass hinges

Anodised or enamelled aluminium profiles.



serie F  
HN

glasses

**04** clear glass

**05** Timeless® anti-corrosion low maintenance glass. NO TPA available

**03** clear bronze  
**07** clear grey

**01** obscure glass  
**08** satin glass  
**11** cathedral  
**12** extra-light

**06** reflecting  
**10** extra-reflex  
**14** satin extra-light  
**29** madras nuvola

**MADE TO MEASURE to the mm**

codici	shower door	hinges and accessories					
<b>width</b>	<b>from 550 to 700 mm</b>	<b>21 31</b>	1.333,00	1.423,00	1.489,00	1.575,00	1.715,00
<b>height</b>	<b>from 1700 to 2100 mm</b>	<b>09 14 15 39 61</b>	1.431,00	1.521,00	1.590,00	1.676,00	1.815,00
		<b>23 32 33 38 52 73 84</b>	1.673,00	1.763,00	1.782,00	1.868,00	2.008,00
		<b>34 35 54</b>	2.254,00	2.344,00	2.387,00	2.474,00	2.614,00
<b>width</b>	<b>from 701 to 900 mm</b>	<b>21 31</b>	1.401,00	1.516,00	1.586,00	1.719,00	1.863,00
<b>height</b>	<b>from 1700 to 2100 mm</b>	<b>09 14 15 39 61</b>	1.496,00	1.612,00	1.685,00	1.820,00	1.962,00
		<b>23 32 33 38 52 73 84</b>	1.739,00	1.855,00	1.877,00	2.011,00	2.156,00
		<b>34 35 54</b>	2.321,00	2.436,00	2.484,00	2.621,00	2.765,00



**Technical specifications**

The height of the element HN is always custom made. Prices refer to height between 1700 and 2100 mm.

If a specific height is not given, the element is supplied 2000 mm high.

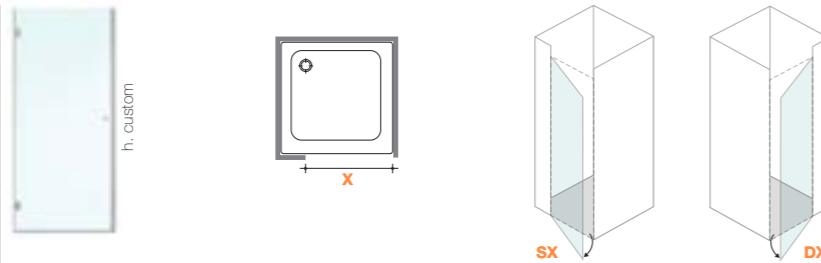

article	boxes	recess dimension X
<b>HN 550÷900</b>	1	Serie F "HN" is always custom made (mm by mm).  Ex: <b>HN 763</b> = shower door for recess from mm 763 a mm 773.

**OPTIONS**

<b>Glass</b>	<b>TPA</b>	133,00	TPA anti-limescale treatment with Virgola included
	<b>Screen printing</b>	144,00	decors: D50 D51 D52 D54 D55 D60 D61
	<b>Personal Glass</b>	222,00	decors: P13 P15 P16 P19 P30 D56 D70
<b>Knob</b>	<b>P3Q</b>		standard knob
	<b>P3T - P0T</b>		no extra charge
	<b>M11F</b>	33,00	
<b>Special sizes</b>	see chart on page 088 for feasibility	+ 20%	special sizes may require a third hinge

**Product description**

Hinged door with aligned fixed panel for recess shower enclosure

**Characteristics**

Made to measure to millimetre precision

In-line fixed panel with 15 mm adjustment

The walls of the recess must be of masonry construction and perfectly plumb

Brass hinges with inward and outward opening

Items in matt black **09**, moka **38** or metal gun **39** finishing are equipped with black seals.

An additional water-stop profile is supplied in the package, which can be used on the edge of the shower tray in order to achieve the best seal.

Maximum heights of up to 300 cm can be achieved with the addition of a third hinge. (see chart on page 088)

SIS™ Simple Installation System.

**Materials**

Tempered glass 8 mm.

Brass hinges

Anodised or enamelled aluminium profiles.



serie F  
H2

glasses

**04** clear glass

**05** Timeless® anti-corrosion low maintenance glass. NO TPA available

**03** clear bronze  
**07** clear grey

**01** obscure glass  
**08** satin glass

**06** reflecting  
**10** extra-reflex

**11** cathedral  
**12** extra-light

**14** satin extra-light  
**29** madras nuvola

**MADE TO MEASURE to the mm**

codici	shower door	hinges and accessories					
<b>width</b>	from 950 to 1100 mm	<b>21 31</b>	1.505,00	1.647,00	1.693,00	1.802,00	1.976,00
<b>height</b>	from 1700 to 2100 mm	<b>09 14 15 39 61</b>	1.645,00	1.787,00	1.837,00	1.947,00	2.122,00
<b>door's dimension</b>	700 mm	<b>23 32 33 38 52 73 84</b>	1.893,00	2.035,00	2.032,00	2.138,00	2.313,00
<b>(1)</b>		<b>34 35 54</b>	2.284,00	2.426,00	2.445,00	2.555,00	2.732,00
<b>width</b>	from 1101 to 1250 mm	<b>21 31</b>	1.581,00	1.742,00	1.808,00	1.976,00	2.155,00
<b>height</b>	from 1700 to 2100 mm	<b>09 14 15 39 61</b>	1.722,00	1.883,00	1.952,00	2.122,00	2.300,00
<b>door's dimension</b>	750 mm	<b>23 32 33 38 52 73 84</b>	1.972,00	2.133,00	2.146,00	2.313,00	2.493,00
<b>(1)</b>		<b>34 35 54</b>	2.364,00	2.525,00	2.562,00	2.732,00	2.912,00
<b>width</b>	from 1251 to 1400 mm	<b>21 31</b>	1.617,00	1.797,00	1.876,00	2.100,00	2.277,00
<b>height</b>	from 1700 to 2100 mm	<b>09 14 15 39 61</b>	1.754,00	1.934,00	2.018,00	2.240,00	2.418,00
<b>door's dimension</b>	800 mm	<b>23 32 33 38 52 73 84</b>	2.000,00	2.180,00	2.206,00	2.429,00	2.605,00
<b>(1)</b>		<b>34 35 54</b>	2.382,00	2.562,00	2.614,00	2.838,00	3.016,00

(1) Price includes 1 fixing bracket (fixing bracket "Q").



**Technical specifications**

The height of the element H2 is always custom made. Prices refer to height between 1700 and 2100 mm.

If a specific height is not given, the element is supplied 2000 mm high.

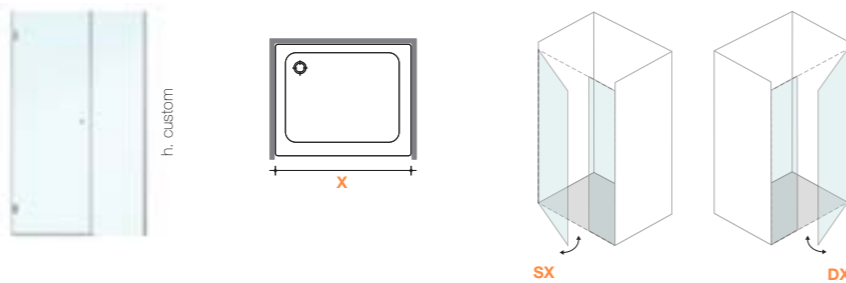

article	boxes	door's dimension	recess dimension X
<b>H2 950÷1100</b>	2	700 mm	Serie F "H2" is always custom made (mm by mm).
<b>H2 1101÷1250</b>	2	750 mm	
<b>H2 1251÷1400</b>	2	800 mm	

Ex: **HN 1225** = shower enclosure for recess from mm 1225 a mm 1240.

**OPTIONS**

<b>Glass</b>	<b>TPA</b>	172,00	TPA anti-limescale treatment with Virgola included
	<b>Screen printing</b>	200,00	decors: D50 D51 D52 D54 D55 D60 D61
	<b>Personal Glass</b>	294,00	decors: P13 P15 P16 P19 P30 D56 D70
<b>Knob</b>	<b>P3Q</b>	standard knob	
	<b>P3T - P0T</b>	no extra charge	
	<b>M11F</b>	33,00	
<b>Special sizes</b>	see chart on page 088 for feasibility	+ 20%	special sizes may require a third hinge

# gliss

collection



# gliss

**Gliss** is the collection of shower enclosures with a new and original technology for sliding doors. The stylistic choice of a minimal frame is combined with the innovative technical solution of the sliding parts: the movements are driven by special floating sliders: the innovative material of which are made ensures perfect sliding performances, thanks to its self-cleaning and self-lubricating properties, tested in years of experience in extremely aggressive workplaces. A simple system, but smart and high tech.



handle M10G

The doors are joined to the top rail by means of two die-cast aluminum supports, bonded directly to the glass using a special adhesive. The slider is then connected with a self-centering adjustable element, to assure a flowing but steady sliding movement.

The overlap between door and fixed glass is always kept to a minimum. Few millimeters of overlap are necessary to ensure correct door regulation.



floating sliders



**aluminium support.**  
The doors are connected to the top rail with two die-cast aluminum supports (always in silver finition)



**the door can be disengaged for an easy maintenance of the shower enclosure.**  
The door can be moved inwards about 15 cm.

The complete range of Vismaravetro profiles is available upon request at the e-mail [info@vismaravetro.it](mailto:info@vismaravetro.it)

The wall must be perpendicular to the element and the fixing base not less than 50 mm.

The installation system needs a free space of 10/12 cm above the shower enclosure to operate with a screw-driver.



standard wall profile AS20

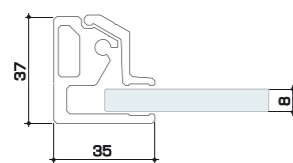

optional wall profile AS10 (on demand - no extra charge)

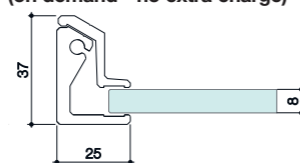

gliss  
type

recess



corner

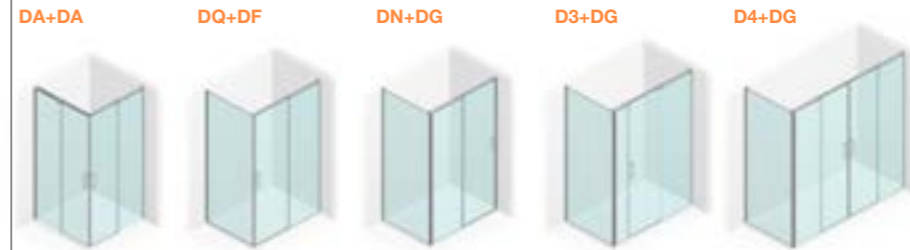

quadrant

3-sided

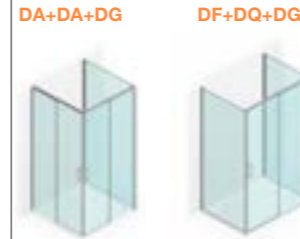

side panel



Custom solutions

The collection Gliss fits to special configurations and bespoke solutions (such as special cuttings for small walls or underroof, models for people with reduced mobility, hotel or residential contracts, solutions for shipbuilding) Please send your enquiry to our technical office at [info@vismaravetro.it](mailto:info@vismaravetro.it)

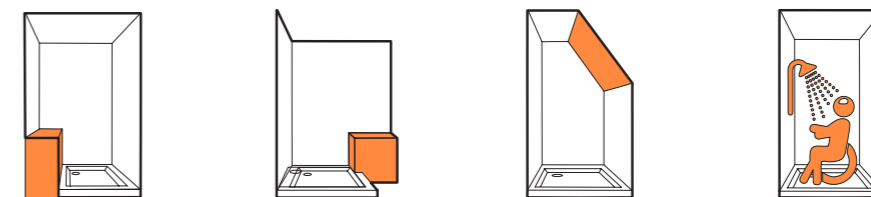

These examples are just indicative. Being customized solutions, it is necessary to submit an enquiry to our Technical Department so to check the feasibility and get an indication of the price.



**Product description**

Shower enclosure with sliding opening, for shower trays in recess, composed by a central sliding door and two fixed lateral panels.

**Characteristics**

Adjustability **60** mm, obtained without the extension of the wall profile, which retains its aesthetic.

Optional compact wall profile **AS10** - supplied under separate order (ATTENTION: adjustability reduced to only 40 mm)

Sliding system by special adjustable floating sliders

Door with releasable system.

Double possibility of adjustment, lateral and longitudinal.

Items in matt black **09** finishing are equipped with black seals.

**S.M.F.** (easy mounting system).

Product conforming to EN 14428:2018 with **CE** marking

**Materials**

Tempered glass 8 mm

Anodized or enamelled aluminium profiles.



**Technical specifications**

Please always advise the exact dimensions of the recess **X** and specify if **DX** right or **SX** left opening.

\* profiles' height 200 cm total height 201 cm

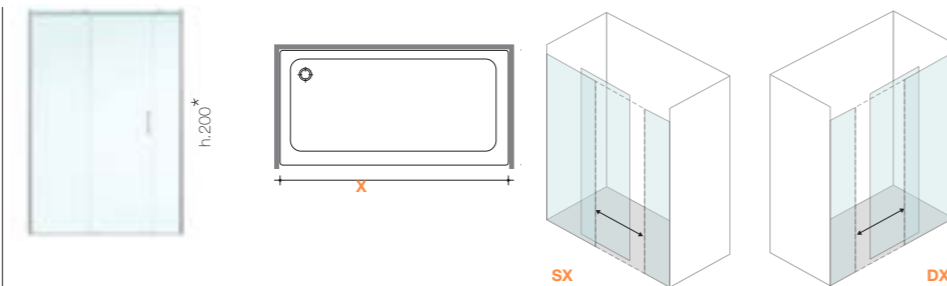

article	boxes	dimension of recess <b>X</b>	opening
<b>D3 138÷199</b>	3	Gliss shower enclosure "D3" is always custom made (cm by cm).  Ex: <b>D3 155</b> = shower enclosure for recess between cm 155 and cm 161.	Unless specific requests, the dimension of the door is approximately 40% of the recess.

**Important:** Gliss shower enclosures are designed to be installed on a standard shower tray. In the case of installation on the floor or on special shower trays that may need a custom size, the installation layout sheet (see pages 338-339) must be complete and attached to the order.

gliss  
**D3**

glasses

<b>04</b> clear glass	<b>05</b> Timeless® anti-corrosion low maintenance glass. NO TPA available	<b>03</b> clear bronze	<b>08</b> satin glass	<b>06</b> reflecting
		<b>07</b> clear grey	<b>12</b> extra-light	<b>10</b> extra-reflex
				<b>14</b> satin extra-light
				<b>29</b> madras nuvola

**MADE TO MEASURE**

codes	dimension of recess	profiles					
<b>D3 138 ... D3 157</b>	+ 60 mm adjustability on item code measure	<b>31</b>	2.551,00	2.753,00	2.893,00	3.149,00	3.461,00
		<b>21</b>	2.593,00	2.795,00	2.936,00	3.192,00	3.514,00
		<b>09 - 14</b>	2.878,00	3.080,00	3.232,00	3.492,00	3.818,00
<b>D3 158 ... D3 177</b>	+ 60 mm adjustability on item code measure	<b>31</b>	2.668,00	2.896,00	3.048,00	3.338,00	3.672,00
		<b>21</b>	2.711,00	2.938,00	3.092,00	3.384,00	3.723,00
		<b>09 - 14</b>	3.010,00	3.238,00	3.403,00	3.700,00	4.040,00
<b>D3 178 ... D3 199</b>	+ 60 mm adjustability on item code measure	<b>31</b>	2.779,00	3.036,00	3.198,00	3.525,00	3.879,00
		<b>21</b>	2.829,00	3.086,00	3.252,00	3.579,00	3.941,00
		<b>09 - 14</b>	3.141,00	3.398,00	3.579,00	3.907,00	4.271,00

**OPTIONS**

Glass	TPA	233,00	treatment preventing limescale TPA Virgola included
	<b>Screen print</b>	222,00	decors: D50 D51 D52 D54 D55 D60 D61
	<b>Personal Glass</b>	333,00	decors: P13 P15 P16 P19 P56 P70
Profiles			
Special sizes	<b>Lower height</b>	+ 5%	less than cm 200
	<b>Higher height</b>	+ 15%	higher height - max. cm 215
	<b>Higher height</b>	+ 30%	higher height - max. cm 230
	<b>Special width</b>	+ 10% on D3 138	less than cm 138 (min. cm 120)
	<b>Special configurations</b>	no extra charge	door/fix configuration in special dimensions

**Custom solutions**

By connecting to the web page shown below, via QR code or by typing the address into your computer browser, you can get information on the custom solutions available for this model and the related additional costs. The examples are just indicative. Being customized solutions, it is necessary to submit an enquiry to our Technical Department so to check the feasibility and get an indication of the price.



[vism.it/L\\_S/L\\_SD3.pdf](http://vism.it/L_S/L_SD3.pdf)

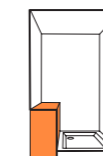

low wall in alignment to the door

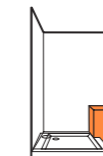

shaped wall

**Product description**

Shower enclosure with sliding opening, for shower trays in recess, composed by two central doors and two fixes lateral panels.

**Characteristics**

Adjustability **60 mm**, obtained without the extension of the wall profile, which retains its aesthetic.

Optional compact wall profile **AS10** - supplied under separate order (ATTENTION: adjustability reduced to only 40 mm)

Magnetic strips. Items in matt black **09** finishing are equipped with black seals.

Sliding system by special adjustable floating sliders

Door with releasable system.

Double possibility of adjustment, lateral and longitudinal, upon completion of the installation, for an easy final adjustment before sealing

**S.M.F.** (easy mounting system).

Product conforming to EN 14428:2018 with **CE** marking

**Materials**

Tempered glass 8 mm

Anodized or enamelled aluminium profiles.



**Technical specifications**

Please always advise the exact dimensions of the recess **X**.

\* profiles' height 200 cm total height 201 cm

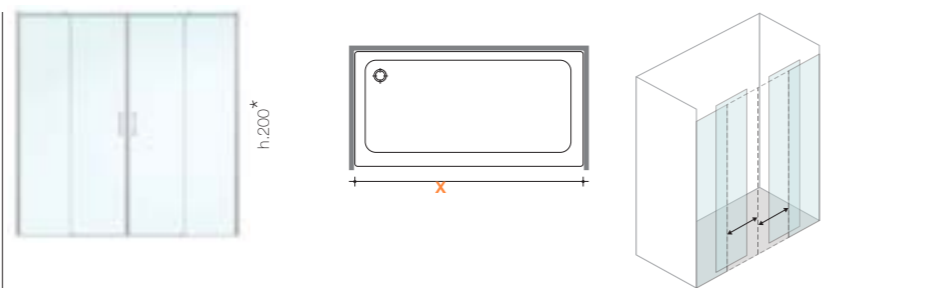

article	boxes	dimension of recess X	opening
<b>D4 158÷219</b>	4	Gliss shower enclosure "D4" is always custom made (cm by cm).  Ex: <b>D4 185</b> = shower enclosure for recess between cm 185 and cm 191.	The dimension of the doors is approximately half of the recess.  Ex. recess: 180 cm opening: 78 cm

**Important:** Gliss shower enclosures are designed to be installed on a standard shower tray. In the case of installation on the floor or on special shower trays that may need a custom size, the installation layout sheet (see pages 338-339) must be complete and attached to the order.

<b>04</b> clear glass	<b>05</b> Timeless® anti-corrosion low maintenance glass. NO TPA available	<b>03</b> clear bronze	<b>08</b> satin glass	<b>06</b> reflecting
		<b>07</b> clear grey	<b>12</b> extra-light	<b>10</b> extra-reflex
				<b>14</b> satin extra-light
				<b>29</b> madras nuvola

**MADE TO MEASURE**

codes	dimension of recess	profiles					
<b>D4 158 ... D4 177</b>	+ 60 mm adjustability on item code measure	<b>31</b>	3.001,00	3.229,00	3.389,00	3.681,00	4.052,00
		<b>21</b>	3.044,00	3.271,00	3.439,00	3.727,00	4.098,00
		<b>09 - 14</b>	3.379,00	3.606,00	3.788,00	4.081,00	4.454,00
<b>D4 178 ... D4 197</b>	+ 60 mm adjustability on item code measure	<b>31</b>	3.122,00	3.377,00	3.551,00	3.878,00	4.267,00
		<b>21</b>	3.172,00	3.427,00	3.604,00	3.927,00	4.323,00
		<b>09 - 14</b>	3.522,00	3.776,00	3.967,00	4.296,00	4.694,00
<b>D4 198 ... D4 219</b>	+ 60 mm adjustability on item code measure	<b>31</b>	3.245,00	3.526,00	3.712,00	4.077,00	4.484,00
		<b>21</b>	3.298,00	3.580,00	3.766,00	4.131,00	4.542,00
		<b>09 - 14</b>	3.662,00	3.944,00	4.138,00	4.505,00	4.921,00

**OPTIONS**

Glass	TPA	261,00	treatment preventing limescale TPA Virgola included
	<b>Screen print</b>	239,00	decors: D50 D51 D52 D54 D55 D60 D61
	<b>Personal Glass</b>	361,00	decors: P13 P15 P16 P19 D56 P70
Profiles			
Special sizes	<b>Lower height</b>	+ 5%	less than cm 200
	<b>Higher height</b>	+ 15%	higher height - max. cm 215
	<b>Higher height</b>	+ 30%	higher height - max. cm 230
	<b>Special width</b>	+ 10% on D4 158	less than cm 158 (min. cm 140)

**Custom solutions**

By connecting to the web page shown below, via QR code or by typing the address into your computer browser, you can get information on the custom solutions available for this model and the related additional costs. The examples are just indicative. Being customized solutions, it is necessary to submit an enquiry to our Technical Department so to check the feasibility and get an indication of the price.



[vism.it/L/S/LSD4.pdf](http://vism.it/L/S/LSD4.pdf)



shaped wall



shower element compatible with the need of people with reduced mobility









**Product description**

Fixed panel DP for installations on a bath tub or on a low wall.

**Characteristics**

Adjustability 20 mm.

Horizontal and vertical adjustment

It can be assembled to all elements of Gliss Programme

Product conforming to EN 14428:2018 with  marking

**Materials**

Tempered glass 8 mm

Anodized or enamelled aluminium profiles.



**Technical specifications**

The DP panel is always custom made. Please advise the correct dimensions (width and height) and specify if left **SX** or right **DX** to the door.

Please always attach to the order sheet the technical drawing (from page 340 to page 343)



article	boxes	dimension L	dimension H
DP 140	1	from 60 to 100	from 100 to 170

gliss  
**DP**

glasses

<b>04</b> clear glass	<b>05</b> Timeless® anti-corrosion low maintenance glass. NO TPA available	<b>03</b> clear bronze	<b>08</b> satin glass	<b>06</b> reflecting
		<b>07</b> clear grey	<b>12</b> extra-light	<b>10</b> extra-reflex
				<b>14</b> satin extra-light
				<b>29</b> madras nuvola

**MADE TO MEASURE**

codes	dimensions	profiles					
<b>DP 140</b>	+ 20 mm adjustability on item code measure	<b>31</b>	780,00	877,00	896,00	996,00	1.096,00
		<b>21</b>	821,00	918,00	940,00	1.037,00	1.138,00
		<b>09 - 14</b>	911,00	1.008,00	1.033,00	1.130,00	1.233,00

**OPTIONS - For customized solutions the additional costs have to be applied on made to measure prices**

<b>Glass</b>	<b>TPA</b>	89,00	treatment preventing limescale TPA
	<b>Screen print</b>	133,00	decors: D50 D51 D52 D54 D55 D60 D61
	<b>Personal Glass</b>	200,00	decors: P19 P70
<b>Profiles</b>			
<b>Special sizes</b>			

**Custom solutions** By connecting to the web page shown below, via QR code or by typing the address into your computer browser, you can get information on the custom solutions available for this model and the related additional costs. The examples are just indicative. Being customized solutions, it is necessary to submit an enquiry to our Technical Department so to check the feasibility and get an indication of the price.



[vism.it/LS/LSDP.pdf](http://vism.it/LS/LSDP.pdf)

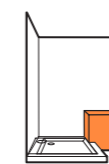

shaped wall

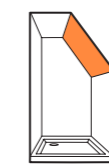

sloped or shape ceiling

collections

# ICONS

sk-in

pag 122

linea

pag 138

twin

pag 164

sintesi

pag 176

replay

pag 202

serie 8000

pag 218

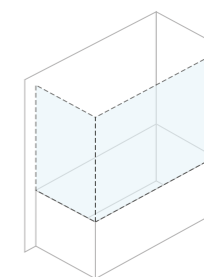
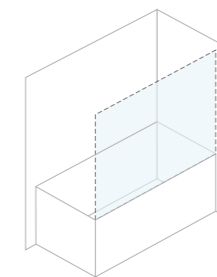
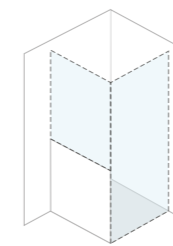
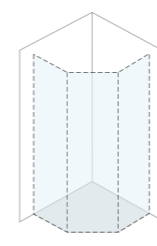
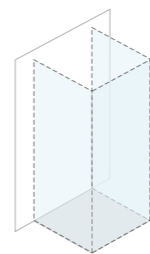
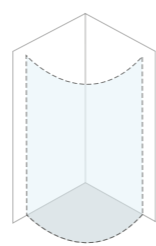
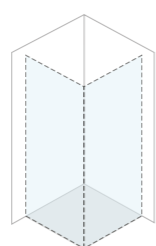
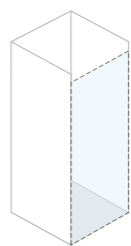

type	recess		corner		quadrant		3-sided		trial		side panel		bath screen 1 side		bath screen 2 sides	
		pag		pag		pag		pag		pag		pag		pag		pag
sk-in	SK	126	SK	126			SB	132								
	SJ	130	CK	128			SZ+SB+SZ	132/134								
			SJ	130			S2+SK+SZ	136/126/134								
			SK+SZ	126/132												
			SK+SY	126/132												
linea	LN	142	LA+LA	154	LT	162	LG+LN+LG	158/142			LN+LP	142/160	LV	312		
	LB	144	LA+LF	154/156	LTX	162	LG+LB+LG	158/144			LB+LP	144/160	FB	310		
	L2	146	LB+LG	144/158			LG+LM+LG	158/150			L2+LP	146/160				
	LZ	148	L2+LG	146/158							L3+LP	152/160				
	LM	150	LZ+LG	148/158												
	L3	152	LM+LG	150/158												
			L3+LG	152/158												
twin	T10-T11-W11	166	T12-T14	166			T13-T15	166								
	T20-T21-W21	168	T22-T24	168			T23-T25	168								
	T30-T31-W31	170	T32	170			T33	170								
	T40-T41-W41	172	T42-T44	172			T43	172								
sintesi	SL	182	SA+SA	188	ST	198	SF+SA+SG	190/188/192	TRS	196	SN+SP	184/194	SV	308	SV+SI	308/310
	SN	184	SA+SF	188/190	SH	198	SG+SM+SG	192/186			SM+SP	186/194	PV	304		
	SM	186	SN+SG	182/192	SX	200										
			SM+SG	184/192	SD	200										
replay	RN	206	RA+RA	210							RN+RV	206/216	SR	302	SR+SE	302/310
	RM	208	RA+RF	210/212							RM+RV	208/216				
			RN+RG	206/214												
			RM+RG	208/214												
serie 8000	CN	222	CA+CA	234			CA+CA+CG	234/236			CN+CP	222/238	VR	300		
	CL	224	CQ+CF	230/232			CG+CQ+CF	236/230/232			C3+CP	226/238	BN	316		
	C3	226	CN+CG	222/236							C4+CP	228/238	B4	316		
	C4	228	C3+CG	226/236												
			C4+CG	228/236												

# sk-in

collection



# sk-in

**Sk-in** is a complete program of walk-in shower solutions, consisting of fixed glass elements and no doors. The glass panels, the profiles and the stabiliser rods fit together thanks to a system which as usual combines design, safety, ease of mounting and water-proof.



The wall must be perpendicular to the door and the fixing base not less than 50 mm..

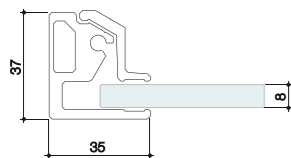

The complete range of Vismaravetro profiles is available upon request at the e-mail [info@vismaravetro.it](mailto:info@vismaravetro.it)



**stabiliser rod**



**ceiling clamp**  
the glass remains far from the ceiling about 25 mm.



**wall profile**



**end cap for SMF profile**



**PST**  
**External towel holder (optional)**  
see page 326 for information and prices



**PSR**  
**External towel holder (optional)**  
see page 326 for information and prices

## sk-in type

### recess



### corner



### quadrant

### 3-sided



### side panel

### Custom solutions

The collection Sk-in fits to special configurations and bespoke solutions (such as special cuttings for small walls or underroof, models for people with reduced mobility, hotel or residential contracts, solutions for shipbuilding)  
Please send your enquiry to our technical office at [info@vismaravetro.it](mailto:info@vismaravetro.it)

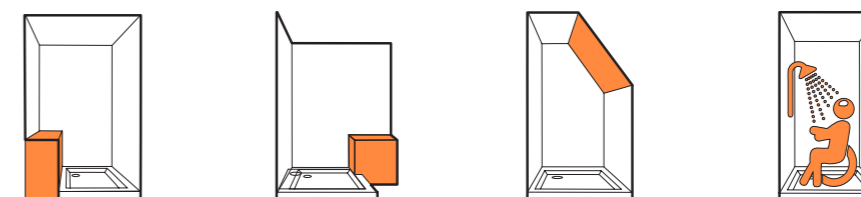

These examples are just indicative. Being customized solutions, it is necessary to submit an enquiry to our Technical Department so to check the feasibility and get an indication of the price.



**Descrizione prodotto**

Walk in shower enclosure, with sliding door, for shower trays in recess or corner

**Characteristics**

Adjustability **30 mm**, obtained without the extension of the wall profile, which retains its aesthetic.

Optional compact wall profile **AS10** - supplied under separate order (ATTENTION: adjustability reduced to only 20 mm)

Door with releasable system.

Double possibility of adjustment, lateral and longitudinal.

Rollers with ball bearings.

External towel holder **PSR** (optional) see pag. 326 for prices and finishings.

**S.M.F.** (easy mounting system).

Product conforming to EN14428:2018 with **CE** marking

**Materials**

Tempered glass 8 mm

Anodized or enamelled aluminium profiles.



**Technical specifications**

Please always specify if **DX** right or **SX** left opening.

\* profiles' height **200 cm**  
total height **201 cm**

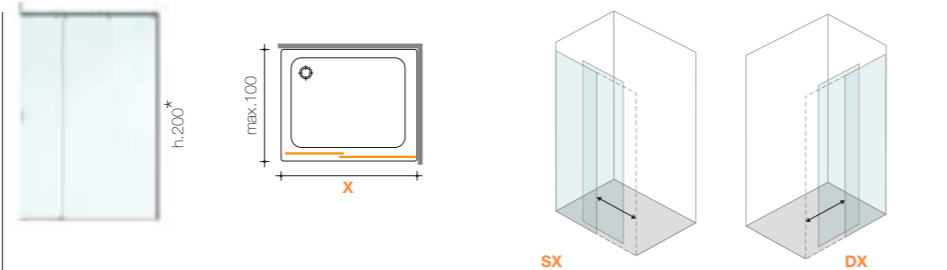

article	boxes	dimensions x	opening
<b>CK 98÷159</b>	2	CK is always custom made (cm x cm)  Ex: <b>CK 137</b> = shower enclosure for installed shower tray between cm 137 and cm 140.	The dimension of the door is approximately 1/3 of the element (door max cm 49)

**ATTENTION:** Sk-in shower enclosures are designed to be installed on a standard shower tray. In the case of installation on the floor or on special shower trays that may need a custom size, the installation layout sheet (see pages 338-339) must be complete and attached to the order.

<b>04</b> clear glass	<b>05</b> Timeless® anti-corrosion low maintenance glass. NO TPA available	<b>03</b> clear bronze	<b>01</b> obscure glass	<b>06</b> reflecting
		<b>07</b> clear grey	<b>08</b> satin glass	<b>10</b> extra-reflex
			<b>11</b> cathedral	<b>14</b> satin extra-light
			<b>12</b> extra-light	<b>29</b> madras nuvola

**MADE TO MEASURE**

codes	dimension of shower tray	profiles					
<b>CK 98 ... CK 117</b> <b>(1)</b>	+ 30 mm adjustability on item code measure	<b>31</b>	1.531,00	1.531,00	1.749,00	1.918,00	2.110,00
		<b>21</b>	1.562,00	1.562,00	1.785,00	1.952,00	2.169,00
		<b>09 - 14 - 39 - 61</b>	1.749,00	1.749,00	1.965,00	2.135,00	2.331,00
<b>CK 118 ... CK 137</b> <b>(1)</b>	+ 30 mm adjustability on item code measure	<b>31</b>	1.646,00	1.646,00	1.901,00	2.098,00	2.308,00
		<b>21</b>	1.681,00	1.681,00	1.933,00	2.131,00	2.369,00
		<b>09 - 14 - 39 - 61</b>	1.885,00	1.885,00	2.128,00	2.327,00	2.543,00
<b>CK 138 ... CK 159</b> <b>(1)</b>	+ 30 mm adjustability on item code measure	<b>31</b>	1.765,00	1.765,00	2.052,00	2.280,00	2.510,00
		<b>21</b>	1.800,00	1.800,00	2.088,00	2.315,00	2.572,00
		<b>09 - 14 - 39 - 61</b>	2.016,00	2.016,00	2.294,00	2.526,00	2.758,00

**(1)** Door's dimension max cm 49

**OPTIONS**

External towel holder		PSR	see page 326 for informations and prices
<b>Glass</b>	<b>TPA</b>	172,00	treatment preventing limescale TPA Virgola included
	<b>Screen print</b>	200,00	decors: D50 D51 D52 D54 D55 D60 D61
	<b>Personal Glass</b>	294,00	decors: P13 P15 P16 P19 P32 P56 P70
	<b>32</b>	+ 20%	on bright silver 21
	<b>05÷15 / 23 / 33 / 38 / 52 / 73 / 84</b>	+ 25%	on bright silver 21
	<b>34 / 35 / 54</b>	1.704,00	on bright silver 21
<b>Special sizes</b>	<b>Lower height</b>	+ 5%	less than cm 200
	<b>Higher height</b>	+ 15%	higher height - max. cm 215







**Product description**

Additional fixed panel for corner or three sided walk-in shower enclosure.

**Characteristics**

Adjustability **20** mm, obtained without the extension of the wall profile, which retains its aesthetic. Optional compact wall profile **AS10** - supplied under separate order. (ATTENTION: adjustability reduced to only 10 mm)

It can be assembled to elements SK or SJ

Double possibility of adjustment, lateral and longitudinal.

External towel holder **PST-PSR** (optional) see pag. 326 for prices and finishings.

**S.M.F.** (easily mounting system).

Product conforming to EN14428:2018 with **CE** marking

**Materials**

Tempered glass 8 mm

Securplus laminated glass (on demand)

Anodised or enamelled aluminium profiles



**Technical specifications**

Please always advise the exact dimensions of the installed shower tray **X** and specify the **DX** right or **SX** left position.

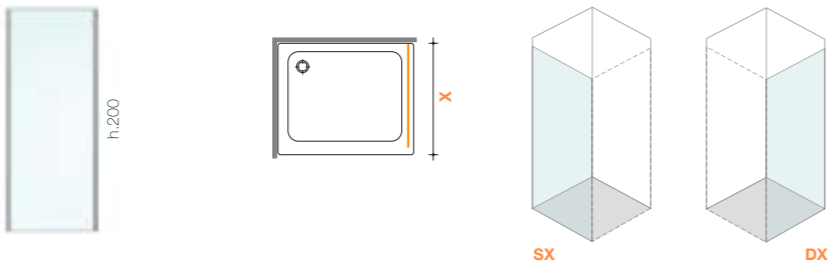

article	boxes	dimension of the installed shower tray <b>X</b>
S2 68÷107	1	The element "S2" is always custom made (cm by cm).  Ex: <b>S2 85</b> = shower enclosure for installed shower tray between cm 85 and cm 87.
S2 108÷119	2	



**Important:** Sk-in shower enclosures are designed to be installed on a standard shower tray. In the case of installation on the floor or on special shower trays that may need a custom size, the **installation layout sheet** (see pages 338-339) must be complete and attached to the order.

sk-in  
S2

glasses

<b>04</b> clear glass	<b>05</b> Timeless® anti-corrosion low maintenance glass. NO TPA available	<b>03</b> clear bronze	<b>01</b> obscure glass	<b>06</b> reflecting
<b>07</b> clear grey	<b>08</b> satin glass	<b>11</b> cathedral	<b>12</b> extra-light	<b>10</b> extra-reflex
				<b>14</b> satin extra-light
				<b>29</b> madras nuvola

**MADE TO MEASURE**

codes	dimensions	profiles	04	05	03	01	06
S2 68 ... S2 77	+ 20 mm adjustability on item code measure	<b>31</b>	826,00	826,00	944,00	1.077,00	1.184,00
		<b>21</b>	848,00	848,00	966,00	1.098,00	1.208,00
		<b>09 - 14 - 39 - 61</b>	941,00	941,00	1.060,00	1.194,00	1.305,00
S2 78 ... S2 87	+ 20 mm adjustability on item code measure	<b>31</b>	881,00	881,00	1.022,00	1.166,00	1.281,00
		<b>21</b>	904,00	904,00	1.043,00	1.189,00	1.308,00
		<b>09 - 14 - 39 - 61</b>	1.003,00	1.003,00	1.146,00	1.292,00	1.412,00
S2 88 ... S2 97	+ 20 mm adjustability on item code measure	<b>31</b>	935,00	935,00	1.100,00	1.260,00	1.384,00
		<b>21</b>	956,00	956,00	1.123,00	1.278,00	1.406,00
		<b>09 - 14 - 39 - 61</b>	1.062,00	1.062,00	1.232,00	1.389,00	1.517,00
S2 98 ... S2 107	+ 20 mm adjustability on item code measure	<b>31</b>	1.027,00	1.027,00	1.212,00	1.382,00	1.521,00
		<b>21</b>	1.052,00	1.052,00	1.234,00	1.406,00	1.548,00
		<b>09 - 14 - 39 - 61</b>	1.170,00	1.170,00	1.354,00	1.527,00	1.672,00
S2 108 ... S2 119 (1)	+ 20 mm adjustability on item code measure	<b>31</b>	1.168,00	1.168,00	1.376,00	1.574,00	1.732,00
		<b>21</b>	1.195,00	1.195,00	1.403,00	1.600,00	1.758,00
		<b>09 - 14 - 39 - 61</b>	1.328,00	1.328,00	1.538,00	1.737,00	1.897,00

**(1) Attention:** packed in wooden box, with no extra cost

**OPTIONS**

<b>Parete radiante - heating panel</b>		see pages 318 ÷ 321 for information and prices
<b>External towel holder</b>	<b>PST - PSR</b>	see page 326 for informations and prices
<b>Glass</b>	<b>TPA</b>	105,00 from S2 68 to S2 97 - treatment preventing limescale TPA
	<b>TPA</b>	150,00 from S2 98 to S2 119 - treatment preventing limescale TPA
	<b>Screen print</b>	144,00 decors: D50 D51 D52 D54 D55 D60 D61
	<b>Personal Glass</b>	222,00 decors: P16 P19 P30 P32 P56 P70
	<b>Etched decor</b>	494,00 decors: A50 A51 A52 (max cm. 199)
	<b>34 Securplus reeded</b>	+ 20% on <b>08</b> satin glass
<b>Profiles</b>	<b>99 Securplus custom laminated glass</b>	on offer
	<b>32</b>	+ 20% on bright silver 21
	<b>05÷15 / 23 / 33 / 38 / 52 / 73 / 84</b>	+ 25% on bright silver 21
	<b>34 / 35 / 54</b>	1.077,00 on bright silver 21
<b>Special sizes</b>	<b>Lower height</b>	+ 5% less than cm 200
	<b>Higher height</b>	+ 15% more than cm 200 - max. cm 215
	<b>Higher height</b>	+ 30% more than cm 215 - max. cm 250 - till max S2 99
	<b>Special width</b>	no extra charge less than 68 cm - min cm 30

**Custom solutions**



[vism.it/LS/LSS2.pdf](http://vism.it/LS/LSS2.pdf)

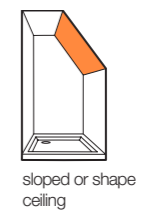
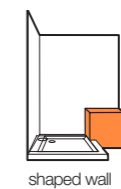
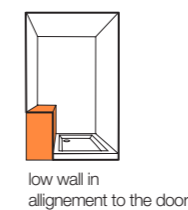

linea  
collection



# linea

**Linea** represents another level of development that has led to the union in a single product of key qualities such as function and simplicity.

Equipped with a pivot door, Linea is an extremely versatile design. Thanks to small profiles and a minimal design, Linea can be used in countless combinations: for recess, corners, walls, with single or double doors and with fixed panels in line with or above low partition walls. A truly flexible design that can adapt to any space.

The development of new technical solutions, top quality materials and attention to the smallest detail, ease of assembly and adjustment using the patented **SMF** system, make using **Linea** a sure bet for reliable results both aesthetically and functionally.



The wall must be perpendicular to the door and the fixing base not less than 50 mm.

**The installation system needs a free space of 10/12 cm above the shower enclosure to operate with a screw-driver.**



magnetic seals



SMF profiles

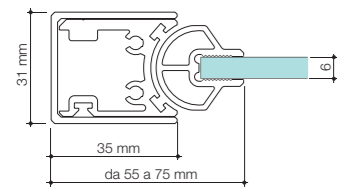

Wall profile on door elements

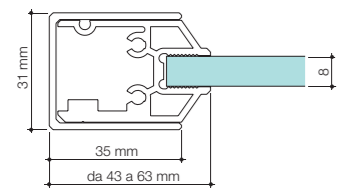

Wall profile on fixed elements

**The complete range of Vismaravetro profiles is available upon request at the e-mail [info@vismaravetro.it](mailto:info@vismaravetro.it)**



handle M7L



wall profile

## linea type

### recess



### corner

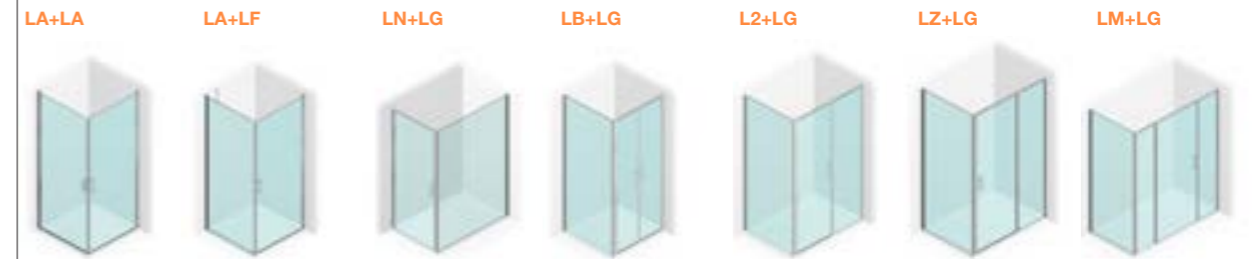

### L3+LG



### quadrant

### LT



### 3-sided



### side panel



### Custom solutions

The collection Linea fits to special configurations and bespoke solutions (such as special cuttings for small walls or underroof, models for people with reduced mobility, hotel or residential contracts, solutions for shipbuilding). Please send your enquiry to our technical office at [info@vismaravetro.it](mailto:info@vismaravetro.it)

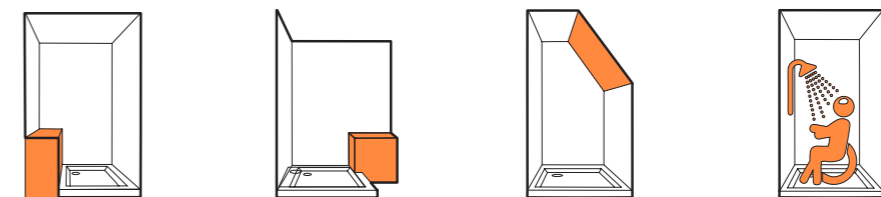

These examples are just indicative. Being customized solutions, it is necessary to submit an enquiry to our Technical Department so to check the feasibility and get an indication of the price.

**Product description**

Frameless shower enclosure, pivot door (180°) for recess.

**Characteristics**

It can be extended up to **30 mm**.

Double possibility of adjustment, lateral and longitudinal, upon completion of the installation, for an easy final adjustment before sealing.

Magnetic strips. Items in matt black **09**, moka **38** or metal gun **39** finishing are equipped with black seals.

Inward and outward opening.

**S.M.F.** (easily mounting system).

Product conforming to EN 14428:2018 with **CE** marking.

**Materials**

Tempered safety glass 6 mm.

Anodised or enamelled aluminium profiles.



**Technical specifications**

Please, always advise the exact dimensions of the recess **X**

Please always specify if left **SX** or right **DX** opening.

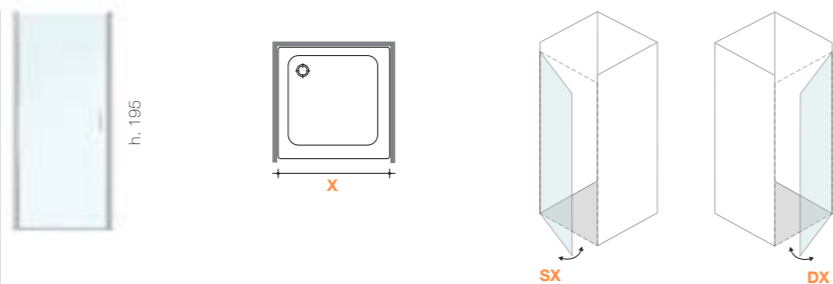

article	boxes	dimension of recess <b>X</b>
<b>LN 68÷99</b>	1	Linea LN shower enclosure is always custom made (cm by cm).  Ex.: <b>LN 68</b> = shower enclosure for a recess dimension between cm. 68 and 71.

**ATTENTION:** Linea shower enclosures are designed to be installed on a standard shower tray. In the case of installation on the floor or on special shower trays that may need a custom size, the installation layout sheet (see pages 338-339) must be complete and attached to the order.

linea  
LN

glasses

<b>04</b> clear glass	<b>04 + TPA</b> Transparent glass with TPA (virgola included)			
-----------------------	--	--	--	--

**STANDARD DIMENSIONS**

codes	dimension of recess	profiles			
<b>LN 67</b>	67-70	<b>21</b> bright silver	<b>1.040,00</b>	<b>1.157,00</b>	<b>ATTENTION</b> the model LN in standard dimension cannot be combined with other elements
<b>LN 77</b>	77-80	<b>21</b> bright silver	<b>1.087,00</b>	<b>1.204,00</b>	
<b>LN 87</b>	87-90	<b>21</b> bright silver	<b>1.159,00</b>	<b>1.276,00</b>	

glasses

<b>04</b> clear glass	<b>05</b> Timeless® anti-corrosion low maintenance glass. NO TPA available	<b>03</b> clear bronze	<b>01</b> obscure glass	<b>06</b> reflecting
		<b>07</b> clear grey	<b>08</b> satin glass	<b>10</b> extra-reflex
			<b>11</b> cathedral	<b>14</b> satin extra-light
			<b>12</b> extra-light	<b>29</b> madras nuvola

**MADE TO MEASURE**

codes	dimension of recess	profiles					
<b>LN 68 ... LN 77</b>	+ 30 mm adjustability on item code measure	<b>31</b>	1.108,00	1.201,00	1.213,00	1.299,00	1.427,00
		<b>21</b>	1.182,00	1.275,00	1.286,00	1.374,00	1.512,00
		<b>09 - 14 - 39 - 61</b>	1.330,00	1.423,00	1.461,00	1.561,00	1.717,00
<b>LN 78 ... LN 87</b>	+ 30 mm adjustability on item code measure	<b>31</b>	1.181,00	1.286,00	1.294,00	1.404,00	1.544,00
		<b>21</b>	1.262,00	1.368,00	1.381,00	1.490,00	1.638,00
		<b>09 - 14 - 39 - 61</b>	1.420,00	1.525,00	1.568,00	1.691,00	1.860,00
<b>LN 88 ... LN 99</b>	+ 30 mm adjustability on item code measure	<b>31</b>	1.243,00	1.364,00	1.373,00	1.499,00	1.648,00
		<b>21</b>	1.326,00	1.447,00	1.459,00	1.582,00	1.742,00
		<b>09 - 14 - 39 - 61</b>	1.493,00	1.614,00	1.656,00	1.795,00	1.978,00

**OPTIONS - For customized solutions the additional costs have to be applied on made to measure prices**

<b>Glass</b>	<b>TPA</b>	133,00	treatment preventing limescale TPA Virgola included
	<b>Screen print</b>	144,00	decors: D50 D51 D52 D54 D55 D60 D61
	<b>Personal Glass</b>	222,00	decors: P13 P15 P16 P19 P30 D56 D70
<b>Profiles</b>	<b>32</b>	+ 20%	on bright silver 21
	<b>05÷15 / 23 / 33 / 38 / 52 / 73 / 84</b>	+ 25%	on bright silver 21
	<b>34 / 35 / 54</b>	1.854,00	on bright silver 21
<b>Special sizes</b>	<b>Lower height</b>	+ 5%	less than cm 195
	<b>Higher height</b>	+ 15%	higher height - max. cm 215
	<b>Higher height</b>	+ 30%	higher height - max. cm 230 - till max LN 87
	<b>Special width</b>	no extra charge	less than cm 68 (min cm 50)

**Custom solutions**

By connecting to the web page shown below, via QR code or by typing the address into your computer browser, you can get information on the custom solutions available for this model and the related additional costs. The examples are just indicative. Being customized solutions, it is necessary to submit an enquiry to our Technical Department so to check the feasibility and get an indication of the price.



[vism.it/LS/LSLN.pdf](http://vism.it/LS/LSLN.pdf)

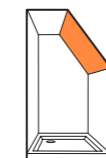

sloped or shape ceiling



shower element compatible with the need of people with reduced mobility







**Product description**

Shower enclosure for recessed shower tray.  
One pivot door 180° and two in line fixed elements.

**Characteristics**

It can be assembled with LG to obtain a corner shower enclosure.

Extensible 40 mm.

Double possibility of adjustment, lateral and longitudinal, upon completion of the installation, for an easy final adjustment before sealing.

Magnetic strips.  
Items in matt black 09, moka 38 or metal gun 39 finishing are equipped with black seals.

Integrated stabiliser profile.

Inward and outward opening.

**S.M.F.**  
(easily mounting system).

Product conforming to EN 14428:2018 with **CE** marking

**Materials**

Tempered glass 6 mm for the door.  
Tempered glass 8 mm for the fix element.  
Laminated safety glass.  
(only for 34 Securplus needed)

Anodised or enamelled aluminium profiles.



**Technical specifications**

Please, always advise the exact dimensions of the installed shower tray **X** and specify if left **SX** or right **DX** opening.

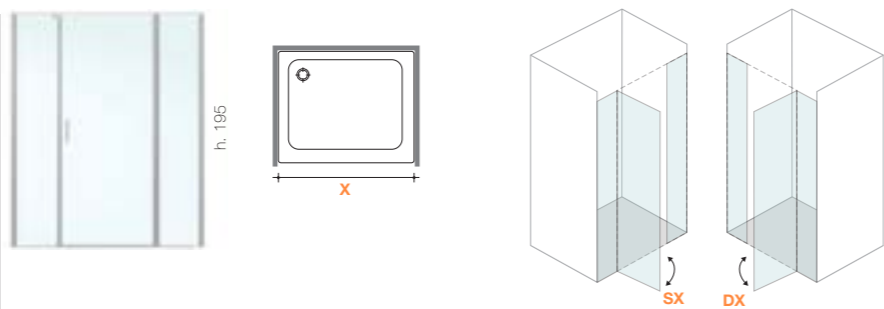

article	boxes	dimension of recess X	opening
LM 138÷179	3	Linea LM shower enclosure is always custom made (cm by cm).  Ex.: LM 145 = shower enclosure for a recess dimension between cm. 145 and 149.	For this model LM, unless specific requests, the dimension of the door is approximately 1/2 of the recess. (max cm. 80)

**! ATTENTION:** Linea shower enclosures are designed to be installed on a standard shower tray. In the case of installation on the floor or on special shower trays that may need a custom size, the installation layout sheet (see pages 338-339) must be complete and attached to the order.

04 clear glass	05 Timeless® anti-corrosion low maintenance glass. NO TPA available	03 clear bronze	01 obscure glass	06 reflecting
		07 clear grey	08 satin glass	10 extra-reflex
			11 cathedral	14 satin extra-light
			12 extra-light	29 madras nuvola

**MADE TO MEASURE**

codes	dimension of recess	profiles					
LM 138 ... LM 147	+ 40 mm adjustability on item code measure	31	2.210,00	2.390,00	2.448,00	2.648,00	2.910,00
		21	2.352,00	2.532,00	2.591,00	2.795,00	3.076,00
		09 - 14 - 39 - 61	2.646,00	2.826,00	2.943,00	3.175,00	3.492,00
LM 148 ... LM 157	+ 40 mm adjustability on item code measure	31	2.278,00	2.471,00	2.537,00	2.767,00	3.043,00
		21	2.414,00	2.607,00	2.681,00	2.907,00	3.199,00
		09 - 14 - 39 - 61	2.716,00	2.909,00	3.044,00	3.302,00	3.634,00
LM 158 ... LM 167 (1)	+ 40 mm adjustability on item code measure	31	2.342,00	2.549,00	2.626,00	2.879,00	3.168,00
		21	2.484,00	2.691,00	2.769,00	3.021,00	3.322,00
		09 - 14 - 39 - 61	2.793,00	2.999,00	3.145,00	3.430,00	3.773,00
LM 168 ... LM 179 (1)	+ 40 mm adjustability on item code measure	31	2.409,00	2.627,00	2.708,00	2.973,00	3.272,00
		21	2.546,00	2.765,00	2.850,00	3.119,00	3.430,00
		09 - 14 - 39 - 61	2.865,00	3.084,00	3.237,00	3.542,00	3.896,00

(1) in addition to the top profile, two fixing brackets are suggested (fixing bracket "Q"). To be requested under separate order.

**OPTIONS - For customized solutions the additional costs have to be applied on made to measure prices**

Category	Option	Cost	Description
Glass	TPA	205,00	treatment preventing limescale TPA Virgola included
	Screen print	222,00	decors: D50 D51 D52 D54 D55 D60 D61
	Personal Glass	333,00	decors: P13 P15 P16 P19 P32 P56 P70
Profiles	32	+ 20%	on bright silver 21
	05÷15 / 23 / 33 / 38 / 52 / 73 / 84	+ 25%	on bright silver 21
	34 / 35 / 54	2.792,00	on bright silver 21
Special sizes	Lower height	+ 5%	less than cm 195
	Higher height	+ 15%	higher height - max. cm 215
	Higher height	+ 30%	higher height - max. cm 230 - till door's dimension max cm. 80
	Special width	+ 10% on LM 138	less than cm 138 (min cm 120)
	Special width	+ 10%	special width fixed panels

**Custom solutions** By connecting to the web page shown below, via QR code or by typing the address into your computer browser, you can get information on the custom solutions available for this model and the related additional costs. The examples are just indicative. Being customized solutions, it is necessary to submit an enquiry to our Technical Department so to check the feasibility and get an indication of the price.



[vism.it/LS/LSLM.pdf](http://vism.it/LS/LSLM.pdf)

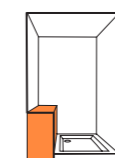

low wall in alignment to the door

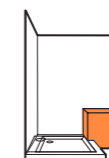

shaped wall

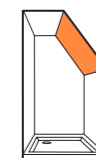

sloped or shape ceiling



shower element compatible with the need of people with reduced mobility

**Product description**

Shower enclosure for recessed shower tray.  
Two pivot doors 180° and one in line fixed element.

**Characteristics**

Extensible **40** mm.

Double possibility of adjustment, lateral and longitudinal, upon completion of the installation, for an easy final adjustment before sealing.

Magnetic strips.  
Items in matt black **09**, moka **38** or metal gun **39** finishing are equipped with black seals.

Inward and outward opening.

It can be assembled with LG to obtain a corner shower enclosure.

Integrated stabiliser profile.

**S.M.F.** (easily mounting system)

Product conforming to EN 14428:2018 with **CE** marking.

**Materials**

Tempered glass 6 mm for the doors.  
Tempered glass 8 mm for the fix element.  
Laminated safety glass.  
(only for 34 Securplus needed)

Anodised or enamelled aluminium profiles



**Technical specifications**

**Please, always advise the exact dimensions of the recess X and specify if left SX or right DX opening.**

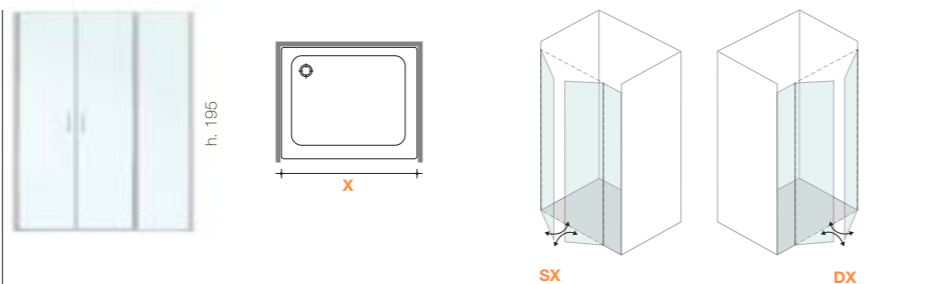

article	boxes	dimension of recess X	opening
<b>L3 138÷143</b>	2	LINEA "L3" shower enclosure is always custom made (cm by cm).  Ex.: <b>L3 145</b> = shower enclosure for a recess dimension between cm. 145 and 149.	Unless specific requests, the dimension of the doors is approximately 2/3 of the recess.
<b>L3 144÷179</b>	3		

**ATTENTION:** Linea shower enclosures are designed to be installed on a standard shower tray. In the case of installation on the floor or on special shower trays that may need a custom size, the installation layout sheet (see pages 338-339) must be complete and attached to the order.

glasses	<b>04</b> clear glass	<b>05</b> Timeless® anti-corrosion low maintenance glass. NO TPA available	<b>03</b> clear bronze	<b>01</b> obscure glass	<b>06</b> reflecting
	<b>07</b> clear grey	<b>08</b> satin glass	<b>11</b> cathedral	<b>10</b> extra-reflex	<b>14</b> satin extra-light
			<b>12</b> extra-light	<b>29</b> madras nuvola	

**MADE TO MEASURE**

codes	dimension of recess	profiles	prices				
<b>L3 138 ... L3 147</b>	+ 40 mm adjustability on item code measure	<b>31</b>	2.428,00	2.607,00	2.668,00	2.876,00	3.151,00
		<b>21</b>	2.569,00	2.748,00	2.815,00	3.019,00	3.307,00
		<b>09 - 14 - 39 - 61</b>	2.917,00	3.097,00	3.196,00	3.428,00	3.755,00
<b>L3 148 ... L3 157</b>	+ 40 mm adjustability on item code measure	<b>31</b>	2.495,00	2.688,00	2.759,00	2.990,00	3.275,00
		<b>21</b>	2.633,00	2.826,00	2.905,00	3.132,00	3.428,00
		<b>09 - 14 - 39 - 61</b>	2.990,00	3.183,00	3.298,00	3.558,00	3.893,00
<b>L3 158 ... L3 167</b>	+ 40 mm adjustability on item code measure	<b>31</b>	2.561,00	2.767,00	2.847,00	3.101,00	3.398,00
		<b>21</b>	2.700,00	2.906,00	2.994,00	3.247,00	3.555,00
		<b>09 - 14 - 39 - 61</b>	3.066,00	3.272,00	3.399,00	3.686,00	4.038,00
<b>L3 168 ... L3 179</b>	+ 40 mm adjustability on item code measure	<b>31</b>	2.628,00	2.847,00	2.929,00	3.197,00	3.503,00
		<b>21</b>	2.767,00	2.986,00	3.077,00	3.341,00	3.662,00
		<b>09 - 14 - 39 - 61</b>	3.142,00	3.361,00	3.493,00	3.794,00	4.158,00

**OPTIONS - For customized solutions the additional costs have to be applied on made to measure prices**

Category	Option	Cost	Description
Glass	<b>TPA</b>	205,00	treatment preventing limescale TPA Virgola included
	<b>Screen print</b>	222,00	decors: D50 D51 D52 D54 D55 D60 D61
	<b>Personal Glass</b>	333,00	decors: P13 P15 P16 P19 P32 P56 P70
Profiles	<b>32</b>	+ 20%	on bright silver 21
	<b>05÷15 / 23 / 33 / 38 / 52 / 73 / 84</b>	+ 25%	on bright silver 21
	<b>34 / 35 / 54</b>	3.086,00	on bright silver 21
Special sizes	<b>Lower height</b>	+ 5%	less than cm 195
	<b>Higher height</b>	+ 15%	higher height - max. cm 215
	<b>Higher height</b>	+ 30%	higher height - max. cm 230
	<b>Special width</b>	+ 10% on L3 138	less than cm 138 (min cm 120)
	<b>Special width</b>	+ 10%	special width fixed panels

**Custom solutions** By connecting to the web page shown below, via QR code or by typing the address into your computer browser, you can get information on the custom solutions available for this model and the related additional costs. The examples are just indicative. Being customized solutions, it is necessary to submit an enquiry to our Technical Department so to check the feasibility and get an indication of the price.



[vism.it/LS/LSL3.pdf](http://vism.it/LS/LSL3.pdf)

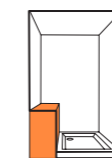

low wall in alignment to the door

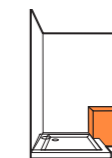

shaped wall

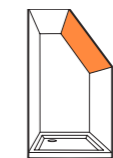

sloped or shape ceiling



shower element compatible with the need of people with reduced mobility

**Product description**

Frameless shower door; can be assembled with a fix element LF or with another LA to obtain a corner shower enclosure.

**Characteristics**

It can be extended up to **20** mm.

Double possibility of adjustment, lateral and longitudinal, upon completion of the installation, for an easy final adjustment before sealing.

Magnetic strips.  
Items in matt black **09**, moka **38** or metal gun **39** finishing are equipped with black seals.

Only outward opening if assembled with LF.

**S.M.F.**  
(easily mounting system).

Product conforming to EN 14428:2018 with **CE** marking.

**Materials**

Tempered safety glass 6 mm.  
Anodised or enamelled aluminium profiles.



**Technical specifications**

Please, always advise the exact dimensions of the installed shower tray and specify if left **SX** or right **DX** opening.

Only outward opening if assembled with LF.

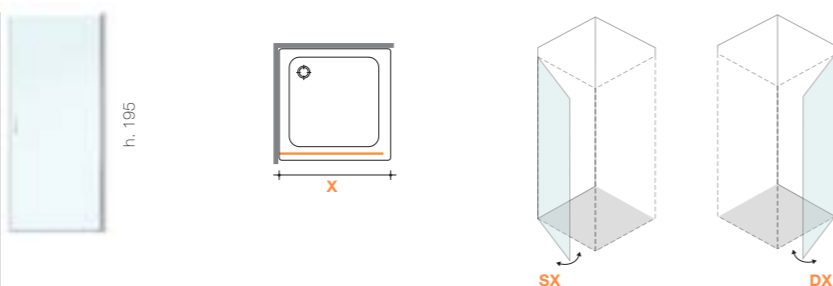

article	boxes	dimension of the installed shower tray <b>X</b>
<b>LA 68÷99</b>	1	Linea LA shower enclosure is always custom made (cm by cm).  Ex.: <b>LA 82</b> = shower enclosure for a recess dimension between cm. 82 and 84.

**! ATTENTION:** Linea shower enclosures are designed to be installed on a standard shower tray. In the case of installation on the floor or on special shower trays that may need a custom size, the installation layout sheet (see pages 338-339) must be complete and attached to the order.

**04** clear glass

**04 + TPA**  
Transparent with TPA  
(virgola included)

**STANDARD DIMENSIONS**

codes	dimension of shower tray	profiles		
<b>LA 68</b>	68-70	<b>21</b> bright silver	<b>852,00</b>	<b>1.029,00</b>
<b>LA 78</b>	78-80	<b>21</b> bright silver	<b>921,00</b>	<b>1.098,00</b>
<b>LA 88</b>	88-90	<b>21</b> bright silver	<b>988,00</b>	<b>1.165,00</b>

**! ATTENTION**  
The model LA in standard dimension can be combined exclusively with an element LF or to another element LA.

**Quick delivery items.**

**04** clear glass

**05** Timeless®  
anti-corrosion low  
maintenance glass

**03** clear bronze  
**07** clear grey

**01** obscure glass  
**08** satin glass

**06** reflecting  
**10** extra-reflex

**11** cathedral  
**12** extra-light

**14** satin extra-light  
**29** madras nuvola

**MADE TO MEASURE**

codes	dimension of shower tray	profiles					
<b>LA 68 ... LA 77</b>	+ 20 mm adjustability on item code measure	<b>31</b>	885,00	978,00	991,00	1.080,00	1.188,00
		<b>21</b>	928,00	1.021,00	1.038,00	1.126,00	1.237,00
		<b>09 - 14 - 39 - 61</b>	1.045,00	1.138,00	1.179,00	1.278,00	1.404,00
<b>LA 78 ... LA 87</b>	+ 20 mm adjustability on item code measure	<b>31</b>	962,00	1.068,00	1.088,00	1.188,00	1.304,00
		<b>21</b>	1.006,00	1.111,00	1.131,00	1.234,00	1.358,00
		<b>09 - 14 - 39 - 61</b>	1.131,00	1.237,00	1.284,00	1.402,00	1.541,00
<b>LA 88 ... LA 99</b>	+ 20 mm adjustability on item code measure	<b>31</b>	1.037,00	1.158,00	1.179,00	1.291,00	1.420,00
		<b>21</b>	1.079,00	1.200,00	1.223,00	1.335,00	1.469,00
		<b>09 - 14 - 39 - 61</b>	1.213,00	1.334,00	1.390,00	1.516,00	1.669,00

**OPTIONS - For customized solutions the additional costs have to be applied on made to measure prices**

<b>Glass</b>	<b>TPA</b>	133,00	treatment preventing limescale TPA Virgola included
	<b>Screen print</b>	144,00	decors: D50 D51 D52 D54 D55 D60 D61
	<b>Personal Glass</b>	222,00	decors: P13 P15 P16 P19 P30 P32 P56 P70
<b>Profiles</b>	<b>32</b>	+ 20%	on bright silver 21
	<b>05÷15 / 23 / 33 / 38 / 52 / 73 / 84</b>	+ 25%	on bright silver 21
	<b>34 / 35 / 54</b>	1.854,00	on bright silver 21
<b>Special sizes</b>	<b>Lower height</b>	+ 5%	less than cm 195
	<b>Higher height</b>	+ 15%	higher height - max. cm 215
	<b>Higher height</b>	+ 30%	higher height - max. cm 230 - till max LA 87
	<b>Special width</b>	no extra charge	less than cm 68 (min cm 50)

**Custom solutions**

By connecting to the web page shown below, via QR code or by typing the address into your computer browser, you can get information on the custom solutions available for this model and the related additional costs. The examples are just indicative. Being customized solutions, it is necessary to submit an enquiry to our Technical Department so to check the feasibility and get an indication of the price.



[vism.it/LS/LSLA.pdf](http://vism.it/LS/LSLA.pdf)



sloped or shape ceiling



shower element compatible with the need of people with reduced mobility



**Product description**

Fixed element for corner or 3 sided shower enclosure.

**Characteristics**

It can be assembled with LN - LB - L2 - LZ - L3 - LM.

It can be extended up to **20 mm**.

Double possibility of adjustment, lateral and longitudinal.

Integrated stabiliser profile.

**S.M.F.**  
(easily mounting system).

Product conforming to EN 14428:2018 with **CE** marking

**Materials**

Tempered safety glass 8 mm.  
Laminated safety glass.  
(only for 34 Securplus reeded)

Anodised or enamelled aluminium.



**Technical specifications**

Please, always advise the exact dimensions of the installed shower tray and specify if left **SX** or right **DX** opening.

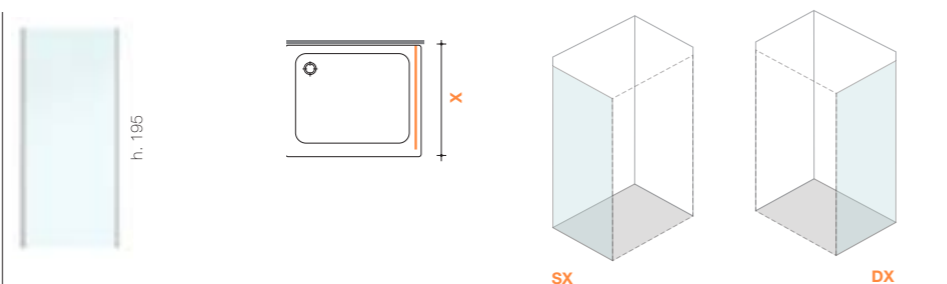

article	boxes	dimension of the installed shower tray X	
<b>LG 68÷139</b>	1	Linea LG shower enclosure is always custom made (cm by cm).	Ex.: <b>LG 85</b> = shower enclosure for a recess dimension between cm. 85 and 87.

**ATTENTION:** Linea shower enclosures are designed to be installed on a standard shower tray. In the case of installation on the floor or on special shower trays that may need a custom size, the installation layout sheet (see pages 338-339) must be complete and attached to the order.

**MADE TO MEASURE**

codes	dimension of shower tray	profiles					
<b>LG 68 ... LG 77</b>	+ 20 mm adjustability on item code measure	31	956,00	1.059,00	1.066,00	1.163,00	1.281,00
		21	997,00	1.100,00	1.107,00	1.202,00	1.322,00
		<b>09 - 14 - 39 - 61</b>	1.121,00	1.224,00	1.258,00	1.366,00	1.502,00
<b>LG 78 ... LG 87</b>	+ 20 mm adjustability on item code measure	31	1.007,00	1.122,00	1.130,00	1.248,00	1.373,00
		21	1.046,00	1.161,00	1.169,00	1.288,00	1.415,00
		<b>09 - 14 - 39 - 61</b>	1.177,00	1.292,00	1.326,00	1.462,00	1.607,00
<b>LG 88 ... LG 97</b>	+ 20 mm adjustability on item code measure	31	1.057,00	1.185,00	1.192,00	1.333,00	1.467,00
		21	1.098,00	1.227,00	1.235,00	1.374,00	1.512,00
		<b>09 - 14 - 39 - 61</b>	1.234,00	1.363,00	1.403,00	1.561,00	1.717,00
<b>LG 98 ... LG 107 (2)</b>	+ 20 mm adjustability on item code measure	31	1.140,00	1.282,00	1.289,00	1.454,00	1.596,00
		21	1.181,00	1.323,00	1.331,00	1.494,00	1.642,00
		<b>09 - 14 - 39 - 61</b>	1.328,00	1.470,00	1.511,00	1.695,00	1.865,00
<b>LG 108 ... LG 117 (1) (2)</b>	+ 20 mm adjustability on item code measure	31	1.280,00	1.434,00	1.444,00	1.628,00	1.792,00
		21	1.319,00	1.473,00	1.485,00	1.669,00	1.837,00
		<b>09 - 14 - 39 - 61</b>	1.484,00	1.638,00	1.687,00	1.895,00	2.087,00
<b>LG 118 ... LG 139 (1) (2)</b>	+ 20 mm adjustability on item code measure	31	1.405,00	1.573,00	1.590,00	1.792,00	1.970,00
		21	1.450,00	1.617,00	1.633,00	1.837,00	2.020,00
		<b>09 - 14 - 39 - 61</b>	1.631,00	1.798,00	1.855,00	2.087,00	2.294,00

(1) **Attention:** Packed in wooden box with no extra costs

(2) **Attention:** It can only be used in corner shower configurations. It cannot be used in 3-sided configurations.

**OPTIONS - For customized solutions the additional costs have to be applied on made to measure prices**

<b>Parete radiante heating panel</b>		see pages 318 ÷ 321 for information and prices	
<b>External towel holder</b>		see page 326 for informations and prices	
<b>Glass</b>	<b>TPA</b>	105,00	from LG 68 to LG 97 - treatment preventing limescale TPA
	<b>TPA</b>	150,00	from LG 98 to LG 139 - treatment preventing limescale TPA
	<b>Screen print</b>	144,00	decors: D50 D51 D52 D54 D55 D60 D61
	<b>Personal Glass</b>	222,00	decors: P13 P15 P16 P19 P30 P32 P56 P70
<b>Profiles</b>	<b>32</b>	+ 20%	on bright silver 21
	<b>05÷15 / 23 / 33 / 38 / 52 / 73 / 84</b>	+ 25%	on bright silver 21
	<b>34 / 35 / 54</b>	1.393,00	on bright silver 21
<b>Special sizes</b>	<b>Lower height</b>	+ 5%	less than cm 195
	<b>Higher height</b>	+ 15%	higher height - max. cm 215
	<b>Higher height</b>	+ 30%	higher height - max. cm 230 - till max LG 99
	<b>Special width</b>	no extra charge	less than cm 68 (min cm 50)

**Custom solutions**

By connecting to the web page shown below, via QR code or by typing the address into your computer browser, you can get information on the custom solutions available for this model and the related additional costs. The examples are just indicative. Being customized solutions, it is necessary to submit an enquiry to our Technical Department so to check the feasibility and get an indication of the price.



[vism.it/LS/LSLG.pdf](https://vism.it/LS/LSLG.pdf)



shaped wall



sloped or shape ceiling

**Product description**

Fixed panel LP for installations on a bath tub or on a low wall.

**Characteristics**

- Extensible **20** mm.
- To be assembled with elemen LN - LB - L2 - LZ - L3 - LM
- Horizontal and vertical of adjustment.
- Integrated stabiliser profile.
- Product conforming to EN 14428:2018 with **CE** marking.

**Materials**

- Tempered glass 8 mm.
- Laminated safety glass. (only for 34 Securplus reeded)
- Anodised or enamelled aluminium profiles.



**Technical specifications**

**The LP panel is always custom made. Please advise the correct dimensions (width and height) and specify if left SX or right DX to the door.**

**Please always attach to the order sheet the technical drawing (from page 340 to page 343)**

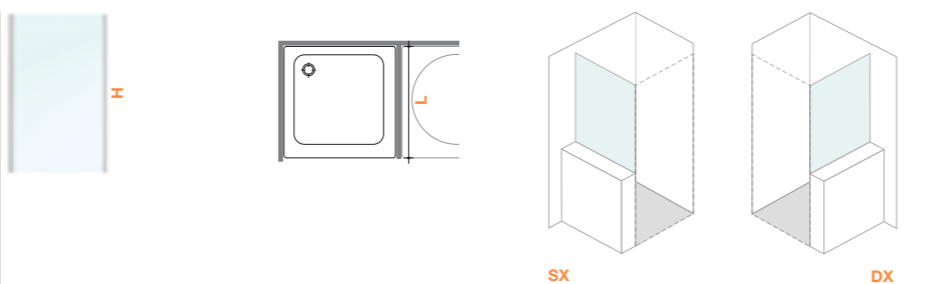

article	boxes	dimensions L	dimensions H
LP 140	1	from 60 to 100	from 100 to 170

<b>04</b> clear glass	<b>05</b> Timeless® anti-corrosion low maintenance glass. NO TPA available	<b>03</b> clear bronze	<b>01</b> obscure glass	<b>06</b> reflecting
		<b>07</b> clear grey	<b>08</b> satin glass	<b>10</b> extra-reflex
			<b>11</b> cathedral	<b>14</b> satin extra-light
			<b>12</b> extra-light	<b>29</b> madras nuvola

**MADE TO MEASURE**

codes	dimensions	profiles					
LP 140	+ 20 mm adjustability on item code measure	<b>31</b>	891,00	988,00	1.018,00	1.120,00	1.230,00
		<b>21</b>	938,00	1.035,00	1.063,00	1.166,00	1.283,00
		<b>09 - 14 - 39 - 61</b>	1.053,00	1.150,00	1.209,00	1.323,00	1.457,00

**OPTIONS - For customized solutions the additional costs have to be applied on made to measure prices**

<b>Glass</b>	<b>TPA</b>	89,00	treatment preventing limescale TPA
	<b>Screen print</b>	133,00	decors: D50 D51 D52 D54 D55 D60 D61
	<b>Personal Glass</b>	200,00	decors: P32 P56 P70
<b>Profiles</b>	<b>32</b>	+ 20%	on bright silver 21
	<b>05÷15 / 23 / 33 / 38 / 52 / 73 / 84</b>	+ 25%	on bright silver 21
	<b>34 / 35 / 54</b>	927,00	on bright silver 21
<b>Special sizes</b>			

**Custom solutions** By connecting to the web page shown below, via QR code or by typing the address into your computer browser, you can get information on the custom solutions available for this model and the related additional costs. The examples are just indicative. Being customized solutions, it is necessary to submit an enquiry to our Technical Department so to check the feasibility and get an indication of the price.

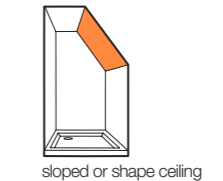
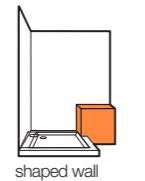
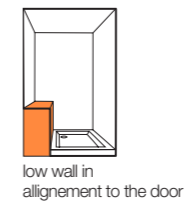

**Product description**

Frameless quadrant shower enclosure with two pivot doors (180°) for round trays (Radius cm 55)

**Characteristics**

- It can be extended up to **20 mm** each side
- Double possibility of adjustment, lateral and longitudinal, upon completion of the installation, for an easy final adjustment before sealing
- Magnetic strips
- Inward and outward opening
- S.M.F.** (easily mounting system)
- Product conforming to EN 14428:2018 with **CE** marking

**Materials**

- Tempered safety glass 6 mm
- Anodised or enamelled aluminium profiles

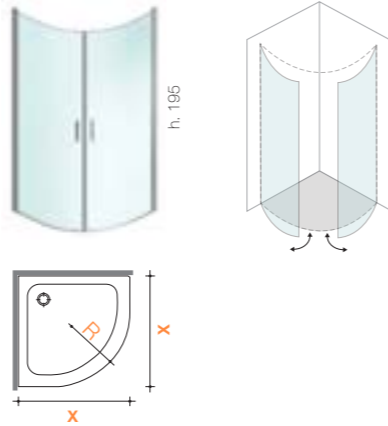

**Technical specifications**

Suitable for quadrant shower trays R. 55 cm

The radius of the quadrant shower tray must be checked by the customer.

article	boxes	dimension of the installed shower tray <b>x</b>	opening	opening space cm
<b>LT 80</b>	2	78÷80	complete	53,5
<b>LT 90</b>	2	88÷90	complete	63,5

**MADE TO MEASURE**

codes	dimension of shower tray	profiles		
<b>LT 80</b>	quadrant shower tray from 78 to 80 cm	<b>31</b>	2.168,00	2.576,00
		<b>21</b>	2.238,00	2.650,00
		<b>09 - 14 - 39 - 61</b>	2.517,00	3.009,00
<b>LT 90</b>	quadrant shower tray from 88 to 90 cm	<b>31</b>	2.310,00	2.768,00
		<b>21</b>	2.379,00	2.840,00
		<b>09 - 14 - 39 - 61</b>	2.677,00	3.227,00

**OPTIONS - For customized solutions the additional costs have to be applied on made to measure prices**

<b>Glass</b>	<b>TPA</b>	294,00	treatment preventing limescale TPA Virgola included
	<b>Screen print</b>		not possible for this model
	<b>Personal Glass</b>		not possible for this model
<b>Profiles</b>	<b>32</b>	+ 20%	on bright silver 21
	<b>05÷15 / 23 / 33 / 38 / 52 / 73 / 84</b>	+ 25%	on bright silver 21
	<b>34 / 35 / 54</b>	2.470,00	on bright silver 21
<b>Special sizes</b>	<b>Special sizes</b>		NO special sizes

**Product description**

Quadrant shower enclosure. Two pivot doors (180°) and two fixed panels for round trays (Radius cm 55)

**Characteristics**

- It can be extended up to **20 mm** each side.
- Double possibility of adjustment, lateral and longitudinal, upon completion of the installation, for an easy final adjustment before sealing.
- Magnetic strips.
- Integrated stabiliser profile.
- Inward and outward opening.
- S.M.F.** (easily mounting system)
- Product conforming to EN 14428:2018 with **CE** marking.

**Materials**

- Tempered glass 6 mm for the doors.
- Tempered glass 8 mm for the fix element.
- Anodised or enamelled aluminium profiles.

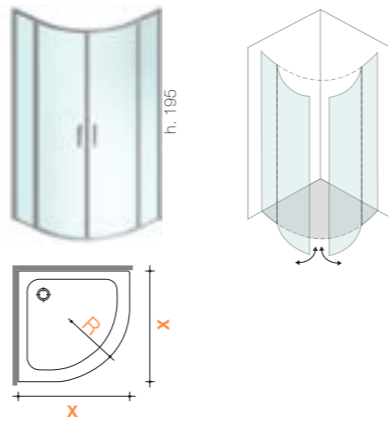

**Technical specifications**

Suitable for quadrant shower trays R. 55 cm

The radius of the quadrant shower tray must be checked by the customer.

article	boxes	dimension of the installed shower tray <b>x</b>	opening	opening space cm
<b>LTX 90</b>	2	88÷90	79	43
<b>LTX 100</b>	3	98÷100	79	43

**MADE TO MEASURE**

codes	dimension of shower tray	profiles		
<b>LTX 90</b>	quadrant shower tray from 88 to 90 cm	<b>31</b>	3.271,00	
		<b>21</b>	3.402,00	
		<b>09 - 14 - 39 - 61</b>	3.827,00	
<b>LTX 100</b>	quadrant shower tray from 98 to 100 cm	<b>31</b>	3.434,00	
		<b>21</b>	3.569,00	
		<b>09 - 14 - 39 - 61</b>	4.015,00	

**OPTIONS - For customized solutions the additional costs have to be applied on made to measure prices**

<b>Glass</b>	<b>TPA</b>	294,00	treatment preventing limescale TPA Virgola included
	<b>Screen print</b>		not possible for this model
	<b>Personal Glass</b>		not possible for this model
<b>Profiles</b>	<b>32</b>	+ 20%	on bright silver 21
	<b>05÷15 / 23 / 33 / 38 / 52 / 73 / 84</b>	+ 25%	on bright silver 21
	<b>34 / 35 / 54</b>	3.397,00	on bright silver 21
<b>Special sizes</b>	<b>Special height</b>		NO special heights
	<b>Special sizes</b>	+ 10%	special width fixed panels

# twin

collection



twin

super  
sintesi

sintesi

replay

junior

gliss

serie 8000

serie 7000

bath  
screens

complements

# twin

**Twin** The first and only shower enclosure collection that offers further opportunities to optimize the bathroom space, in line with new functional and practical needs connected with available space. Next to the shower enclosure, an authentic container to use for storing things or setting up appliances. It's also the perfect aesthetic solution.



The wall must be perpendicular to the door and the fixing base not less than 50 mm.

The installation system needs a free space of 10/12 cm above the shower enclosure to operate with a screw-driver.

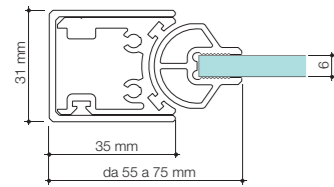

Wall profile on door elements

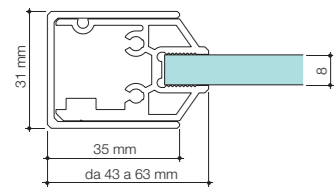

Wall profile on fixed elements

The complete range of Vismaravetro profiles is available upon request at the e-mail [info@vismaravetro.it](mailto:info@vismaravetro.it)



handle for Twin collection



TWIN MINI available on demand

twin type

recess

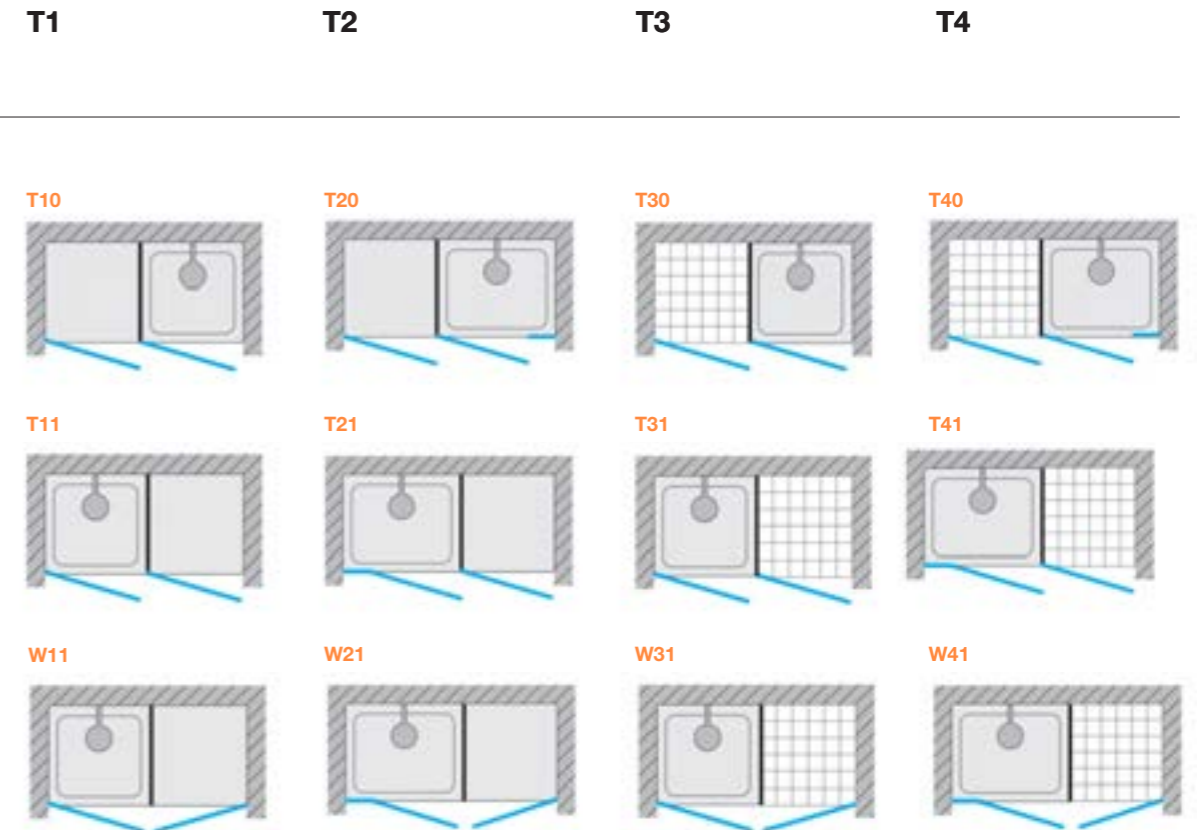

corner

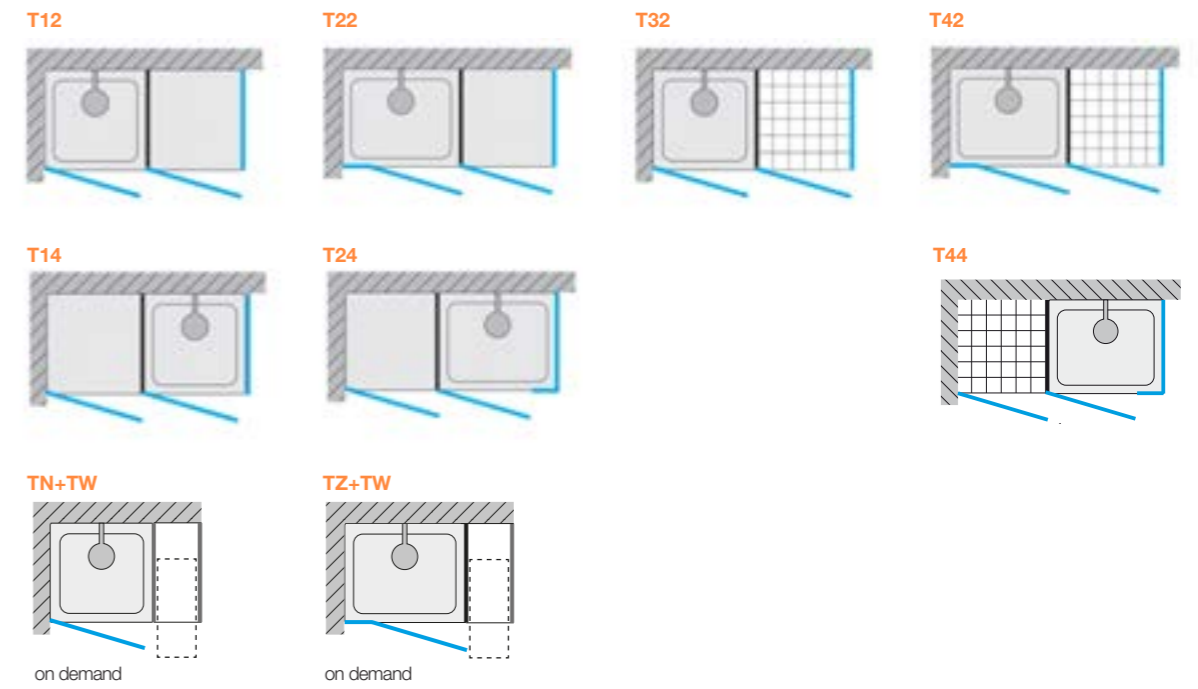

3-sided

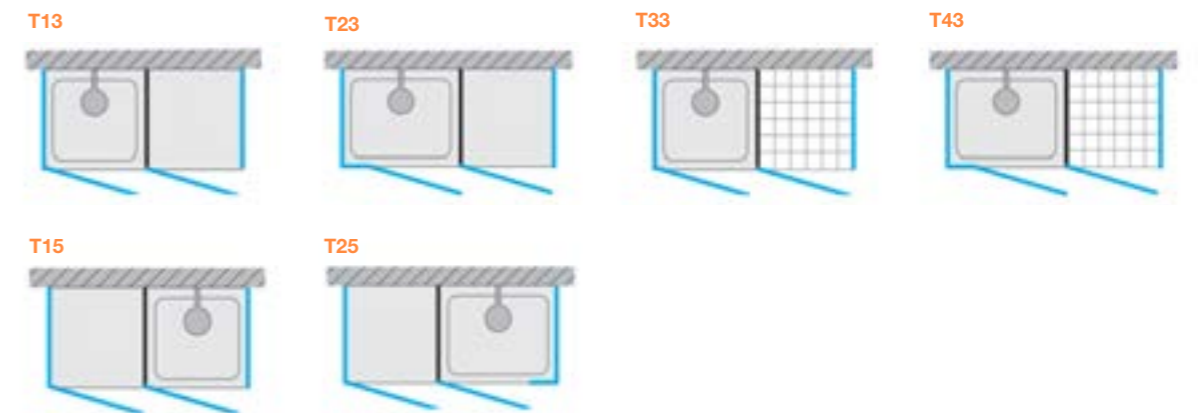

**Product description**

Double unit made of a technical space and a shower space, suitable for installation on Gemini shower tray 80x160 cm. or directly on the floor.

**Characteristics**

- Double adjustment possibility.
- Magnetic strips.
- Minimum adjustment 20 mm.
- **S.M.F.** (easily mounting system).
- Pivot door, outward opening.
- PVC bottom profiles for waterproof.
- Product conforming to EN 14428:2018 with **CE** marking.
- Version with parallel doors suitable for the installation of electrical household appliances.
- Possibility to equip with shelves (not included).
- PVC bottom profiles for waterproof.
- A top profile gives stability to unit, avoiding the use of a fixing bracket in standard solutions for recess and corner installations.

**Materials**

- Tempered glass 6 mm. for the doors.
- Tempered glass 8 mm. for the fixed panels.
- Anodised or enamelled aluminium frames.
- Door of the technical space with mirror surface, white lacquered back side.
- Fixed separating panel in extra light glass, white lacquered.



T14S



**Version with "parallel" doors**

The two doors opens in parallel (either right hand or left hand). The door of the technical space allows an entrance of about 70 cm.

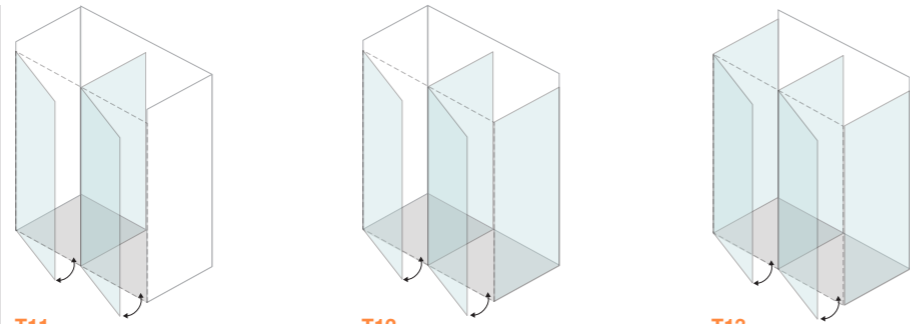

T11

n° boxes 3

T12

n° boxes 4

T13

n° boxes 5

**Version with "convergent" doors**

The two doors open opposite (one right hand and the other left hand). The door of the technical space allows an entrance of about 70 cm. This version must not be used for the installation of washing machines, drying machines or any other electrical appliance.

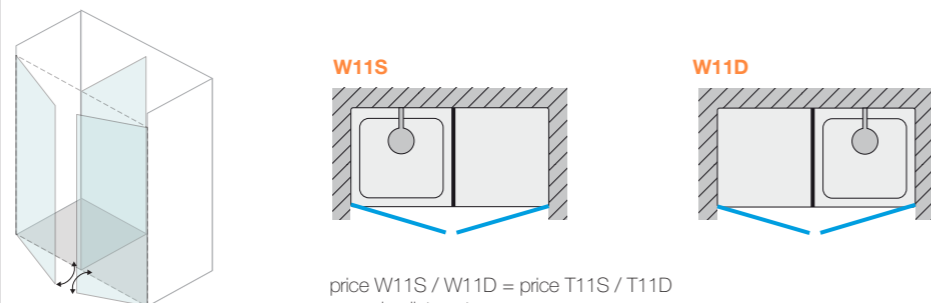

W11

n° boxes 3

W11S

W11D

price W11S / W11D = price T11S / T11D  
see price list next page

**recess**

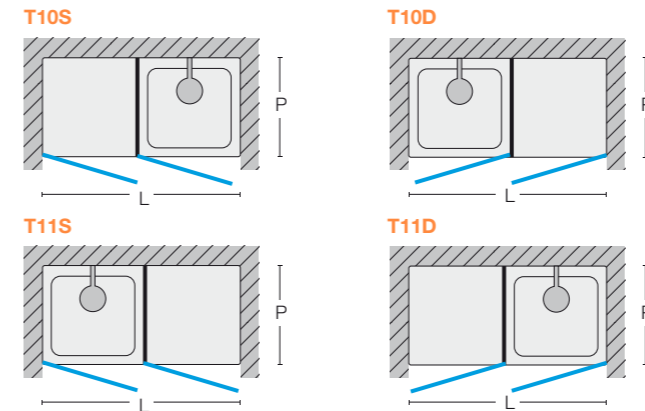

STANDARD		profiles	
width L = 160 adjustment 156,5 - 159,5	14 - 31	3.420,00	4.071,00
depth P = 80 adjustment 78 - 80		3.485,00	4.137,00
height H = 195	09 - 39 - 61	3.905,00	4.540,00
MADE to MEASURE		profiles	
width L = 155÷165	14 - 31	3.734,00	4.413,00
depth P = 70÷90		3.794,00	4.477,00
height H = 195	09 - 39 - 61	4.252,00	4.914,00

**corner**

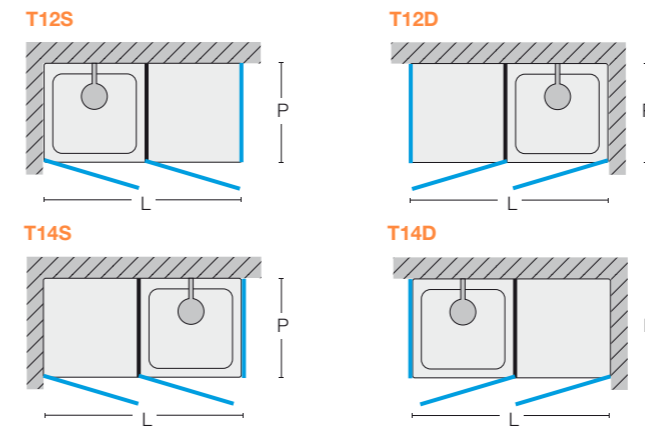

STANDARD		profiles	
width L = 160 adjustment 158 - 161	14 - 31	4.321,00	5.133,00
depth P = 80 adjustment 78 - 80		4.401,00	5.215,00
height H = 195	09 - 39 - 61	4.931,00	5.721,00
MADE to MEASURE		profiles	
width L = 155÷165	14 - 31	4.685,00	5.547,00
profondità P = 70÷90		4.765,00	5.631,00
height H = 195	09 - 39 - 61	5.340,00	6.178,00

**3-sides (1)**

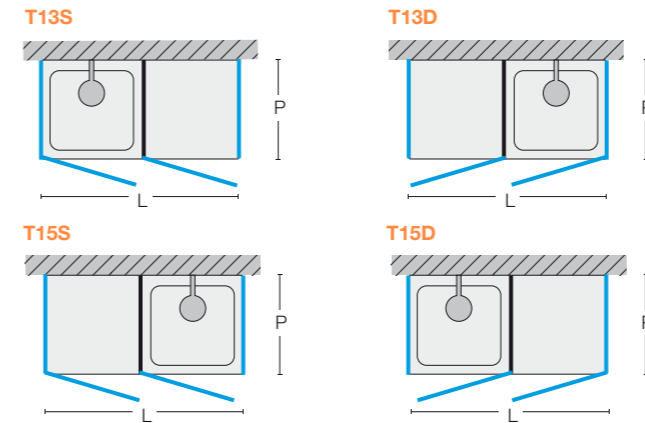

STANDARD		profiles	
width L = 160 adjustment 158,5 - 160,5	14 - 31	5.219,00	6.190,00
depth P = 80 adjustment 78 - 80		5.319,00	6.290,00
height H = 195	09 - 39 - 61	5.961,00	6.903,00
MADE to MEASURE		profiles	
width L = 155÷165	14 - 31	5.642,00	6.680,00
depth P = 70÷90		5.741,00	6.784,00
height H = 195	09 - 39 - 61	6.432,00	7.446,00

(1) Price includes two fixing brackets "Q" (see pag. 330).

OPTIONS - For customized solutions the additional costs have to be applied on made to measure prices			
<b>Parete radiante heating panel</b>			see pages 318 ÷ 321 for information and prices
<b>Glass</b>	TPA per T10 - T11 - T12	205,00	treatment preventing limescale TPA Virgola included
	TPA per T13 - T14 - T15	278,00	treatment preventing limescale TPA Virgola included
	<b>Personal Glass</b>	to quote	decors: P13 P15 P16 P19
<b>Special sizes</b>	03 clear bronze / 07 clear grey	+ 5%	on clear glass 04
	<b>Less than cm 195</b>	+ 10%	on made to measure price
	<b>More than cm 195 (max 215)</b>	+ 20%	on made to measure price
	<b>Deeper than cm 90</b>	+ 10%	on made to measure price

**Product description**

Double unit made of a technical space and a shower space, suitable for installation on Gemini shower tray 80x180 cm. or directly on floor.

**Characteristics**

- Double adjustment possibility.
- Magnetic strips.
- Minimum adjustment 20 mm.
- **S.M.F.** (easily mounting system).
- Pivot door, outward opening.
- PVC bottom profiles for waterproof.
- A top profile gives stability to unit, avoiding the use of a fixing bracket in standard solutions for recess and corner installations.
- Product conforming to EN 14428:2018 with **CE** marking.
- Version with parallel doors suitable for the installation of electrical household appliances.
- Possibility to equip with shelves (not included).

**Materials**

- Tempered glass 6 mm. for the doors.
- Tempered glass 8 mm. for the fixed panels.
- Anodised or enamelled aluminium frames.
- Door of the technical space with mirror surface, white lacquered back side.
- Fixed separating panel in extra light glass, white lacquered.



**Version with "parallel" doors**

The two doors opens in parallel (either right hand or left hand).  
The door of the technical space allows an entrance of about 67 cm.

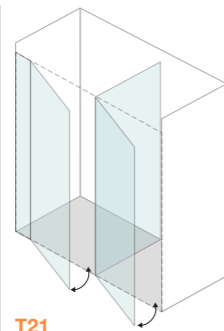

**T21**  
n° boxes 4

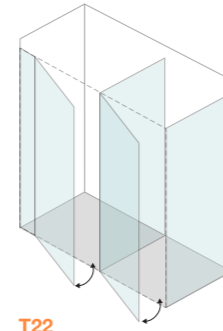

**T22**  
n° boxes 5

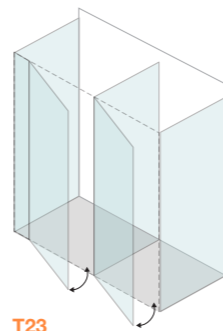

**T23**  
n° boxes 6

**Version with "convergent" doors**

The two doors open opposite (one right hand and the other left hand).  
The door of the technical space allows an entrance of about 67 cm.  
**This version must not be used for the installation of washing machines, drying machines or any other electrical appliance.**

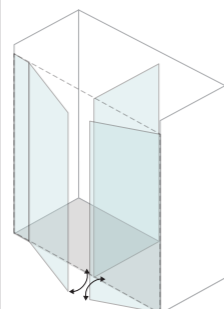

**W21**  
n° boxes 4

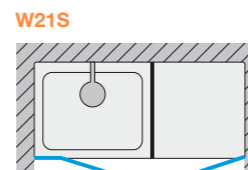

price W21S / W21D = price T21S / T21D  
see price list next page

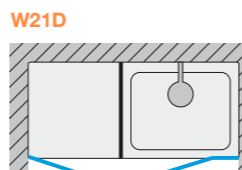

**recess**

**T20S**

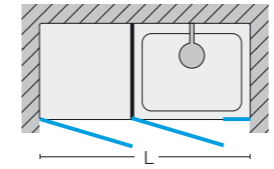

**T20D**

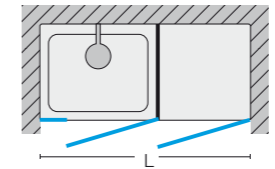

**T21S**

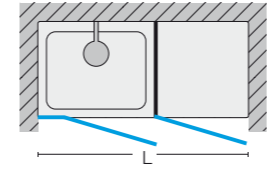

**T21D**

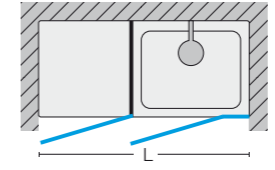

**corner**

**T22S**

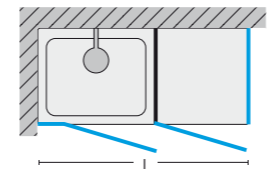

**T22D**

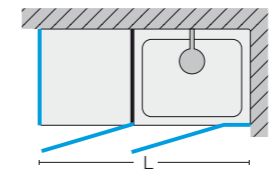

**T24S**

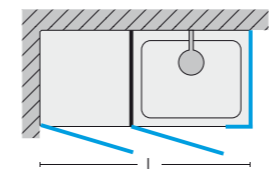

**T24D**

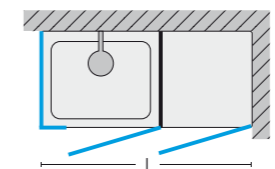

**3-sides (1)**

**T23S**

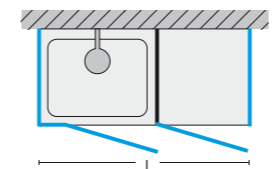

**T23D**

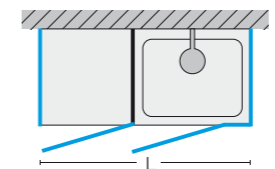

**T25S**

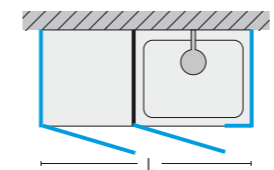

**T25D**

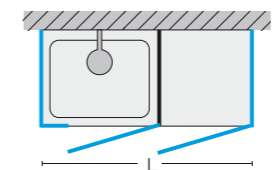

	profiles	04 clear glass	08 satin glass 12 extra-light
<b>STANDARD</b>	width L = 180 adjustment 176,5 - 179,5	3.980,00	4.724,00
	depth P = 80 adjustment 78 - 80	4.070,00	4.817,00
	height H = 195	4.562,00	5.286,00
<b>MADE to MEASURE</b>	width L = 160÷195	4.309,00	5.083,00
	depth P = 70÷90	4.401,00	5.176,00
	height H = 195	4.931,00	5.683,00
<b>STANDARD</b>	width L = 180 adjustment 178 - 181	4.878,00	5.780,00
	depth P = 80 adjustment 78 - 80	4.985,00	5.894,00
	height H = 195	5.587,00	6.468,00
<b>MADE to MEASURE</b>	width L = 160÷190	5.267,00	6.220,00
	profondità P = 70÷90	5.371,00	6.328,00
	height H = 195	6.021,00	6.947,00
<b>STANDARD</b>	width L = 180 adjustment 178,5 - 180,5	5.775,00	6.840,00
	depth P = 80 adjustment 78 - 80	5.904,00	6.970,00
	height H = 195	6.617,00	7.650,00
<b>MADE to MEASURE</b>	width L = 160÷190	6.217,00	7.353,00
	depth P = 70÷90	6.347,00	7.479,00
	height H = 195	7.112,00	8.212,00

(1) Price includes two fixing brackets "Q" (see pag. 330).

**OPTIONS - For customized solutions the additional costs have to be applied on made to measure prices**

		see pages 318 ÷ 321 for information and prices
<b>Parete radiante heating panel</b>		
<b>Glass</b>	<b>TPA</b> per T20 - T21 - T22	233,00 treatment preventing limescale TPA Virgola included
	<b>TPA</b> per T23 - T24 - T25	305,00 treatment preventing limescale TPA Virgola included
	<b>Personal Glass</b>	to quote decors: P13 P15 P16 P19
	<b>03</b> clear bronze / <b>07</b> clear grey	+ 5% on clear glass O4
<b>Special sizes</b>	<b>Less than cm 195</b>	+ 10% on made to measure price
	<b>More than cm 195 (max 215)</b>	+ 20% on made to measure price
	<b>Deeper than cm 90</b>	+ 10% on made to measure price

**Product description**

Double unit suitable for already installed standard shower trays next to a technical space on floor.

**Characteristics**

- Double adjustment possibility.
- Magnetic strips.
- Minimum adjustment 20 mm.
- **S.M.F.**  
(easily mounting system).
- Pivot door, outward opening.
- PVC bottom profiles for waterproof.
- A top profile gives stability to unit, avoiding the use of a fixing bracket in standard solutions for recess and corner installations.
- Product conforming to EN 14428:2018 with **CE** marking.
- Version with parallel doors suitable for the installation of electrical appliances.
- Possibility to equip with shelves (not included).

**Materials**

- Tempered glass 6 mm. for the doors.
- Tempered glass 8 mm. for the fixed panels.
- Anodised or enamelled aluminium frames.
- Door of the technical space with mirror surface, white lacquered back side.
- Fixed separating panel in extra light glass, white lacquered.



**IMPORTANT:** please always indicate the height in mm of the shower tray from the floor.

**Version with "parallel" doors**

The two doors opens in parallel (either right hand or left hand).  
The door of the technical space allows an entrance of about 70 cm.

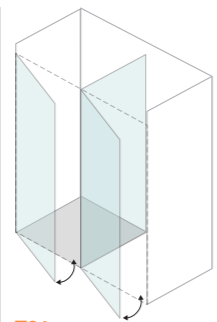

T31

n° boxes 3

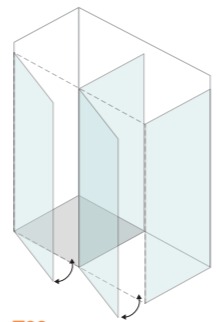

T32

n° boxes 4

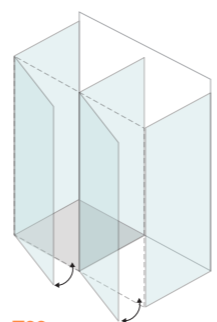

T33

n° boxes 5

**Version with "convergent" doors**

The two doors open opposite (one right hand and the other left hand).  
The door of the technical space allows an entrance of about 70 cm.

This version must not be used for the installation of washing machines, drying machines or any other electrical appliance.

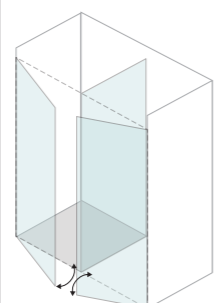

W31

n° boxes 3

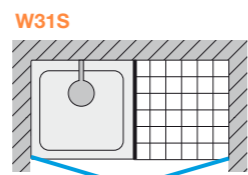

W31S

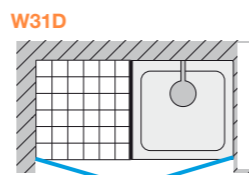

W31D

price W31S / W31D = price T31S / T31D  
see price list next page

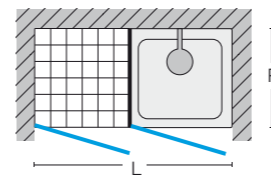
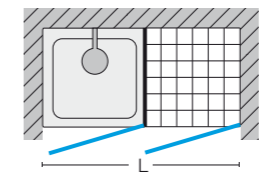
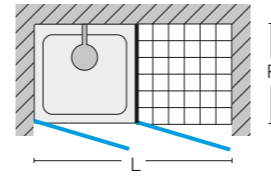
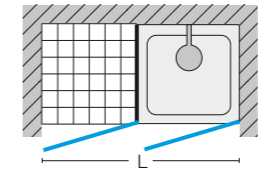
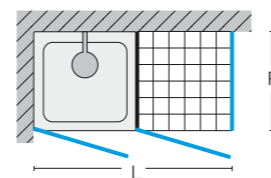
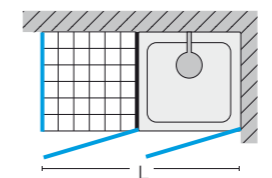
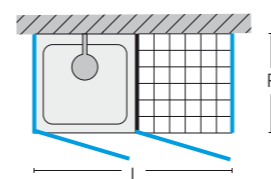
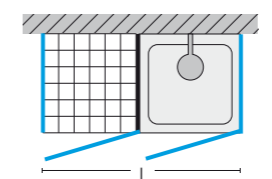
**recess****T30S****T30D****T31S****T31D****corner****T32S****T32D****3-sided (1)****T33S****T33D**

	MADE to MEASURE	profiles		
width L = 155÷160 depth P = 70÷90 shower unit's height (measured from the shower tray) H = 195		<b>14 - 31</b>	3.842,00	4.527,00
		<b>21</b>	3.905,00	4.590,00
		<b>09 - 39 - 61</b>	4.377,00	5.039,00
width L = 155÷160 depth P = 70÷90 shower unit's height (measured from the shower tray) H = 195		<b>14 - 31</b>	4.795,00	5.659,00
		<b>21</b>	4.877,00	5.744,00
		<b>09 - 39 - 61</b>	5.466,00	6.305,00
width L = 155÷160 depth P = 70÷90 shower unit's height (measured from the shower tray) H = 195		<b>14 - 31</b>	5.749,00	6.793,00
		<b>21</b>	5.849,00	6.899,00
		<b>09 - 39 - 61</b>	6.555,00	7.571,00

(1) Price includes two fixing brackets "Q" (see pag. 330).

**OPTIONS - For customized solutions the additional costs have to be applied on made to measure prices**

			see pages 318 ÷ 321 for information and prices
<b>Parete radiante heating panel</b>			
<b>Glass</b>	<b>TPA per T30 - T31 - T32</b>	205,00	treatment preventing limescale TPA Virgola included
	<b>TPA per T33 - T34</b>	278,00	treatment preventing limescale TPA Virgola included
	<b>Personal Glass</b>	to quote	decors: P13 P15 P16 P19
	<b>03 clear bronze / 07 clear grey</b>	+ 5%	on clear glass 04
<b>Special sizes</b>	<b>Less than cm 195</b>	+ 10%	on made to measure price
	<b>More than cm 195 (max 215)</b>	+ 20%	on made to measure price
	<b>Deeper than cm 90</b>	+ 10%	on made to measure price

**Product description**

Double unit suitable for already installed standard shower trays next to a technical space on floor.

**Characteristics**

- Double adjustment possibility
- Magnetic strips
- Minimum adjustment 20 mm.
- **S.M.F.** (easily mounting system).
- Pivot door, outward opening.
- PVC bottom profiles for waterproof.
- A top profile gives stability to unit, avoiding the use of a fixing bracket in standard solutions for recess and corner installations.
- Product conforming to EN 14428:2018 with **CE** marking.
- Version with parallel doors suitable for the installation of electrical household appliances.
- Possibility to equip with shelves (not included)

**Materials**

- Tempered glass 6 mm for the doors.
- Tempered glass 8 mm for the fixed panels.
- Anodised or enamelled aluminium frames.
- Door of the technical space with mirror surface, white lacquered back side.
- Fixed separating panel in extra light glass, white lacquered.



**IMPORTANT:** please always indicate the height in mm of the shower tray from the floor.

**Version with "parallel" doors**

The two doors are opening one right hand, the other left hand (convergent)  
The door of the technical space allows an entrance of about 67 cm.  
This version must not be used for the installation of washing machines, drying machines or any other electrical appliance..

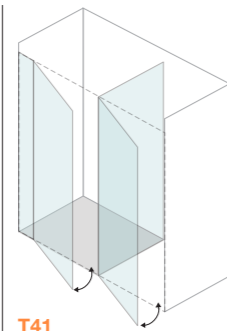

**T41**  
n° boxes 4

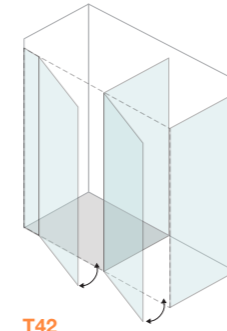

**T42**  
n° boxes 5

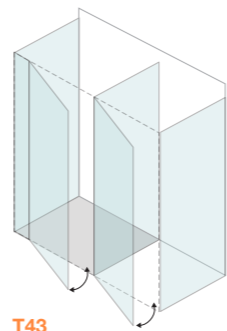

**T43**  
n° boxes 6

**Version with "convergent" doors**

The two doors open opposite (one right hand and the other left hand).  
The door of the technical space allows an entrance of about 67 cm.  
This version must not be used for the installation of washing machines, drying machines or any other electrical appliance.

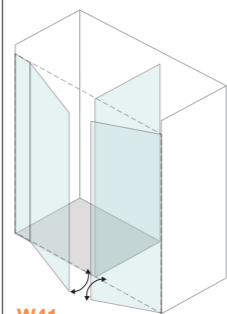

**W41**  
n° boxes 4

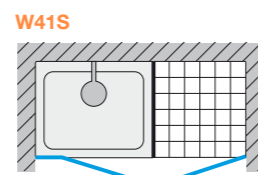

price W41S / W41D = price T41S / T41D  
see price list next page

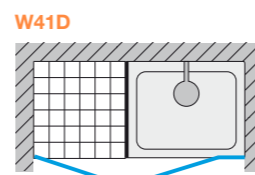

**recess**

**T40S**

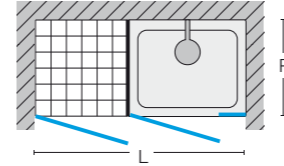

**T40D**

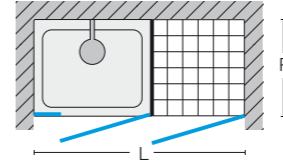

**T41S**

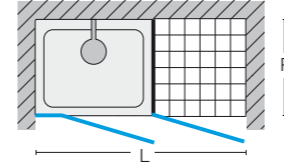

**T41D**

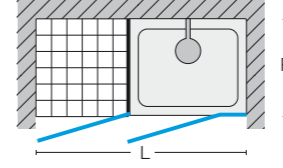

**corner**

**T42S**

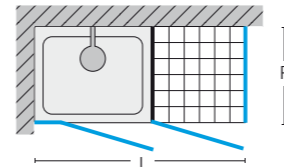

**T42D**

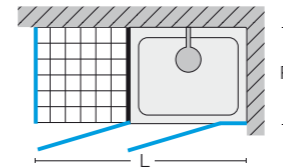

**T44S**

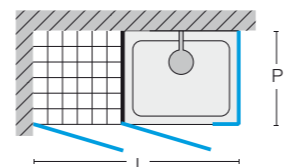

**T44D**

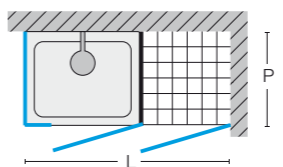

**3-sides (1)**

**T43S**

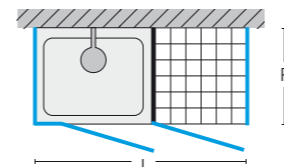

**T43D**

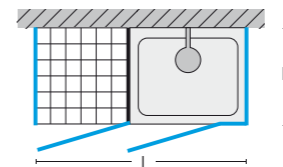

**MADE to MEASURE** profiles

width L = 160÷190	<b>14 - 31</b>	4.420,00	5.198,00
depth P = 70÷90	<b>21</b>	4.510,00	5.291,00
shower unit's height (measured from the shower tray) H = 195	<b>09 - 39 - 61</b>	5.056,00	5.812,00

**MADE to MEASURE** profiles

width L = 160÷190	<b>14 - 31</b>	5.374,00	6.329,00
depth P = 70÷90	<b>21</b>	5.481,00	6.441,00
shower unit's height (measured from the shower tray) H = 195	<b>09 - 39 - 61</b>	6.144,00	7.072,00

**MADE to MEASURE** profiles

width L = 160÷190	<b>14 - 31</b>	6.326,00	7.463,00
depth P = 70÷90	<b>21</b>	6.454,00	7.594,00
shower unit's height (measured from the shower tray) H = 195	<b>09 - 39 - 61</b>	7.233,00	8.336,00

(1) Price includes two fixing brackets "Q" (see pag. 330).

**OPTIONS - For customized solutions the additional costs have to be applied on made to measure prices**

<b>Parete radiante heating panel</b>		see pages 318 ÷ 321 for information and prices
<b>Glass</b>	<b>TPA</b> per T40 - T41 - T42	233,00 treatment preventing limescale TPA Virgola included
	<b>TPA</b> per T43 - T44	305,00 treatment preventing limescale TPA Virgola included
<b>Personal Glass</b>		to quote decors: P13 P15 P16 P19
	03 clear bronze / 07 clear grey	+ 5% on clear glass 04
<b>Special sizes</b>	<b>Less than cm 195</b>	+ 10% on made to measure price
	<b>More than cm 195 (max 215)</b>	+ 20% on made to measure price
	<b>Deeper than cm 90</b>	+ 10% on made to measure price

sintesi

collection



# sintesi

**Sintesi** is a programme responding to the current market trend with extraordinary results: combining the aesthetic advantage of a frameless solution with mounting easiness and simplicity, thanks to the innovative fitting system, which is really at everybody level.



The wall must be perpendicular to the door and the fixing base not less than 50 mm.

The installation system needs a free space of 10/12 cm above the shower enclosure to operate with a screw-driver.

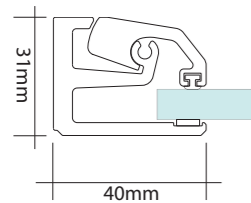

The complete range of Vismaravetro profiles is available upon request at the e-mail [info@vismaravetro.it](mailto:info@vismaravetro.it)



wall profile

hinge Sintesi



optional aluminium magnetic seal

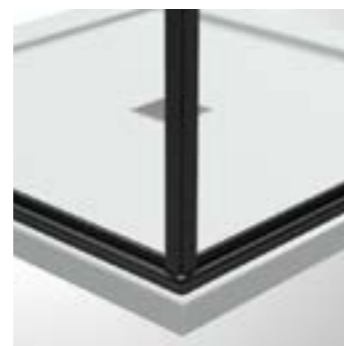

Items in matt black 09, moka 38 or metal gun 39 finishing are equipped with black seals.

## sintesi type

### recess



### corner

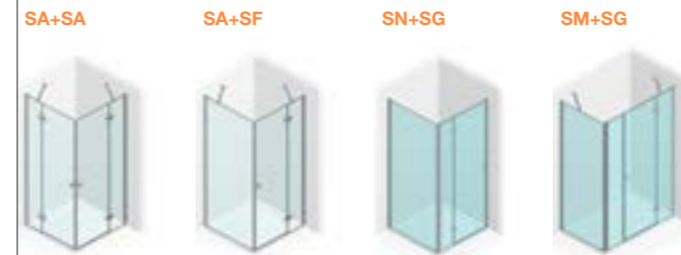

### quadrant / pentagonal

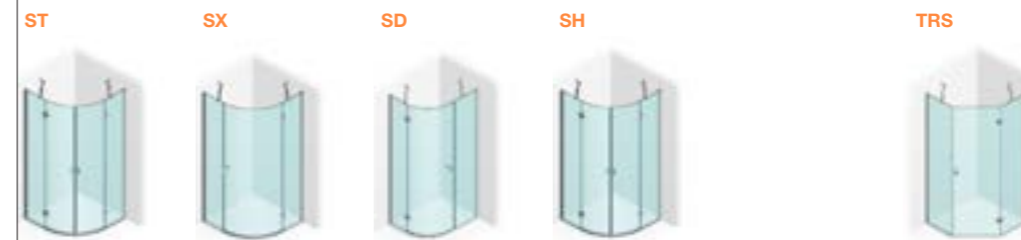

### 3-sided



### side panel



### Custom solutions

The collection Sintesi fits to special configurations and bespoke solutions (such as special cuttings for small walls or underroof, models for people with reduced mobility, hotel or residential contracts, solutions for shipbuilding) Please send your enquiry to our technical office at [info@vismaravetro.it](mailto:info@vismaravetro.it)

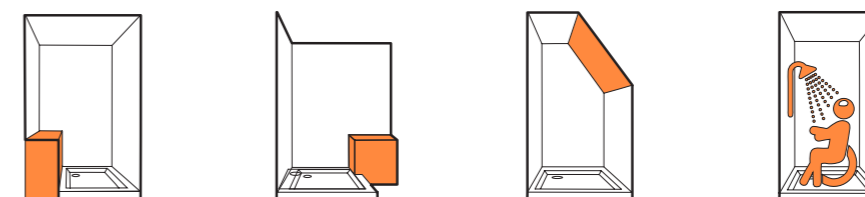

These examples are just indicative. Being customized solutions, it is necessary to submit an enquiry to our Technical Department so to check the feasibility and get an indication of the price.

# hinges sintesi

Hinge with a maximum outward opening angle of 105°. It is supplied as standard hinge with the models:

**SN, SM, SA, TRS**

On demand for the model SD

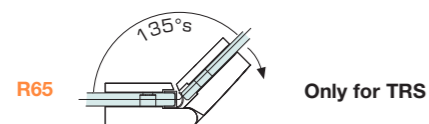
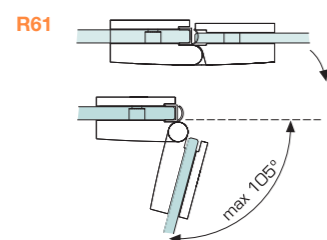
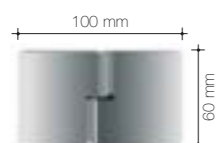

Round hinge.

It is supplied as standard hinge with the models:

**ST, SH, SX, SD.**

On demand for the other models

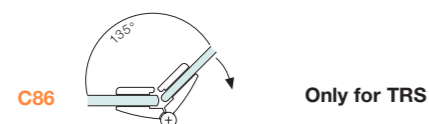
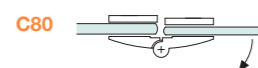
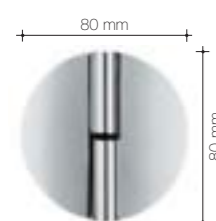

Wall hinge.

It is supplied as standard hinge with the model:

**SL**

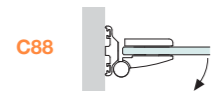
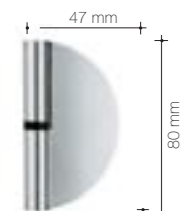

Rectangular hinge available on demand for Sintesi programme.

It is supplied as standard hinge with the bathscreen programme on the models:

**SR, SV, PV**

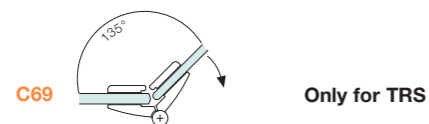
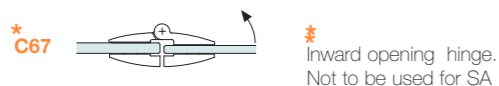
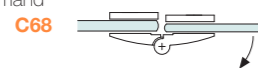
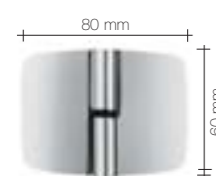

# knobs and handles sintesi

Square knob.

It is supplied as standard knob with the models:

**SN, SM, SA, TRS**

On demand for the other models



**P3Q**

Round knob.

It is supplied as standard knob with the models:

**ST, SH, SX, SD, SL**

On demand for the other models



**P3T**

On demand knobs



**P2C** transparent crystal handle\* **P2S** satin crystal handle\*

The metal ring is always chromed

On demand handle

Extra charge: **39,00**



**M3L**

**Product description**

Frameless shower enclosure for recessed shower trays up to 80 cm.

**Characteristics**

Outward opening door.

Suitable only for perfectly vertical walls.

Extensible **10** mm.

PVC seals with magnetic strips.  
Items in matt black **09**, moka **38** or metal gun **39** finishing are equipped with black seals.

**S.M.F.**

(easily mounting system).

Product conforming to EN 14428:2018 with **CE** marking.

**Materials**

Tempered glass 6 mm.

Anodised or enamelled aluminium profiles.

Unless specific requests, **Sintesi SL** shower enclosures are supplied with standard hinges **C88** and standard knob **P3T**.



**Technical specifications**

**Please always advise the exact dimensions of the recess X and specify if left SX or right DX opening.**

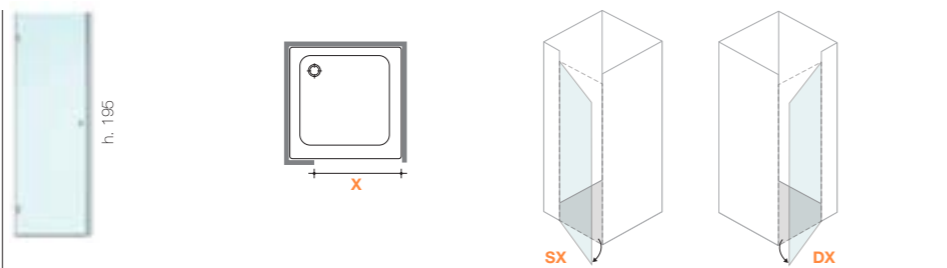

article	boxes	dimension of recess X
SL 55÷79	1	"SL" shower door is always custom made (cm by cm).  Ex: <b>SL 62</b> = shower enclosure for recess from cm 62 to cm 63.

**ATTENTION:** Sintesi shower enclosures are designed to be installed on a standard shower tray. In the case of installation on the floor or on special shower trays that may need a custom size, the installation layout sheet (see pages 338-339) must be complete and attached to the order.

sintesi  
**SL**

glasses

<b>04</b> clear glass	<b>05</b> Timeless® anti-corrosion low maintenance glass. <b>NO TPA</b> available	<b>03</b> clear bronze	<b>01</b> obscure glass	<b>06</b> reflecting
		<b>07</b> clear grey	<b>08</b> satin glass	<b>10</b> extra-reflex
			<b>11</b> cathedral	<b>14</b> satin extra-light
			<b>12</b> extra-light	<b>29</b> madras nuvola

**MADE TO MEASURE**

codes	dimension of recess	profiles					
<b>SL 55 ... SL 67</b>	+ 10 mm adjustability on item code measure	<b>31</b>	934,00	1.017,00	1.071,00	1.177,00	1.302,00
		<b>21</b>	952,00	1.036,00	1.090,00	1.194,00	1.324,00
		<b>09 - 14 - 39</b>	1.059,00	1.142,00	1.201,00	1.306,00	1.435,00
<b>SL 68 ... SL 79</b>	+ 10 mm adjustability on item code measure	<b>31</b>	991,00	1.088,00	1.148,00	1.272,00	1.407,00
		<b>21</b>	1.010,00	1.107,00	1.171,00	1.288,00	1.425,00
		<b>09 - 14 - 39</b>	1.124,00	1.221,00	1.290,00	1.407,00	1.546,00

**OPTIONS**

<b>Glass</b>	<b>TPA</b>	133,00	treatment preventing limescale TPA Virgola included
	<b>Screen print</b>	144,00	decors: D50 D51 D52 D54 D55 D60 D61
	<b>Personal Glass</b>	222,00	decors: P13 P15 P16 P19 P32 P56 P70
<b>Profiles</b>	<b>Aluminium magnetic profile</b>	105,00	magnetic strip in aluminium profile
	<b>32</b>	+ 20%	on bright silver 21
	<b>05÷15 / 23 / 33 / 38 / 73 / 84</b>	+ 25%	on bright silver 21
<b>Special sizes</b>	<b>Lower height</b>	+ 5%	less than cm 196
	<b>Higher height</b>	+ 15%	higher height - max. cm 215
	<b>Higher height</b>	+ 30%	higher height - max. cm 230 - till max SL 67
	<b>Special width</b>	no extra charge	less than cm 55 (min cm 45)

**Custom solutions**

By connecting to the web page shown below, via QR code or by typing the address into your computer browser, you can get information on the custom solutions available for this model and the related additional costs. The examples are just indicative. Being customized solutions, it is necessary to submit an enquiry to our Technical Department so to check the feasibility and get an indication of the price.



[vism.it/LS/LSSL.pdf](http://vism.it/LS/LSSL.pdf)



sloped or shape ceiling



shower element compatible with the need of people with reduced mobility

**Product description**

Shower enclosure for recessed shower trays. It consists of a pivot door hinged to a fixed panel.

**Characteristics**

Outward opening door.  
Adjustability **30** mm, obtained without the extension of the wall profile, which retains its aesthetic.

Double possibility of adjustment, lateral and longitudinal, upon completion of the installation, for an easy final adjustment before sealing.

PVC seals with magnetic strips.  
Items in matt black **09**, moka **38** or metal gun **39** finishing are equipped with black seals.

**S.M.F.** (easily mounting system).

Product conforming to EN 14428:2018 with **CE** marking.

**Materials**

Tempered glass 6 mm for the door.  
Tempered glass 8 mm for the fixed element.

Anodised or enamelled aluminium profiles.

Unless specific requests, **Sintesi SN** shower enclosures are supplied with standard hinges **R61** and standard knob **P3Q**.



**Technical specifications**

Please always advise the exact dimensions of the recess **X** and specify if left **SX** or right **DX** opening.

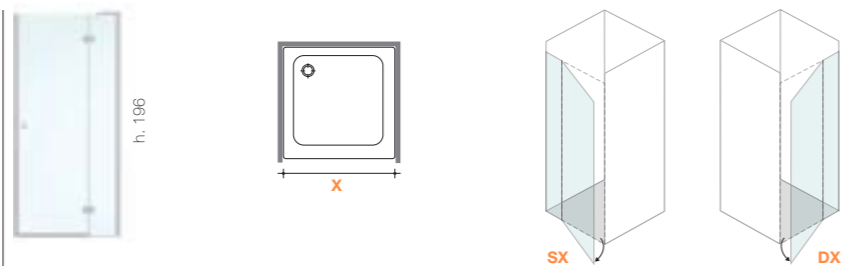

article	boxes	dimension of recess <b>X</b>	opening
serie Sintesi <b>SN 68÷95</b> <b>SN 96÷129</b>	1 2	Sintesi SN is always custom made (cm by cm).  Ex: <b>SN 78</b> = shower enclosure for recess from cm 78 to cm 81	The dimension of the door is approximately 2/3 of the recess and corresponds to the opening space (max 61 cm.)

**ATTENTION:** Sintesi shower enclosures are designed to be installed on a standard shower tray. In the case of installation on the floor or on special shower trays that may need a custom size, the installation layout sheet (see pages 338-339) must be complete and attached to the order.

sintesi  
**SN**

**STANDARD DIMENSIONS**

codes	dimension of recess	profiles	glasses <b>04</b> clear glass	<b>04 + TPA</b> Treatment preventing limescale TPA Virgola included
<b>SN 77</b>	77-80	<b>21</b> bright silver	<b>1.181,00</b>	<b>1.314,00</b>
<b>SN 87</b>	87-90	<b>21</b> bright silver	<b>1.231,00</b>	<b>1.364,00</b>
<b>SN 97</b>	97-100	<b>21</b> bright silver	<b>1.404,00</b>	<b>1.537,00</b>
<b>SN 107</b>	107-110	<b>21</b> bright silver	<b>1.464,00</b>	<b>1.597,00</b>
<b>SN 117</b>	117-120	<b>21</b> bright silver	<b>1.520,00</b>	<b>1.653,00</b>

**ATTENTION**  
the model **SN** in standard dimensions cannot be combined with other elements

**MADE TO MEASURE**

codes	dimension of recess	profiles	glasses <b>04</b> clear glass	<b>05</b> Timeless® anti-corrosion low maintenance glass. <b>NO TPA</b> available	<b>03</b> clear bronze	<b>01</b> obscure glass	<b>06</b> reflecting
<b>SN 68 ... SN 77</b> (1)	+ 30 mm adjustability on item code measure	<b>31</b>	1.270,00	1.363,00	1.425,00	1.544,00	1.712,00
		<b>21</b>	1.294,00	1.388,00	1.455,00	1.573,00	1.742,00
		<b>09 - 14 - 39</b>	1.440,00	1.533,00	1.603,00	1.723,00	1.894,00
<b>SN 78 ... SN 87</b> (1)	+ 30 mm adjustability on item code measure	<b>31</b>	1.324,00	1.430,00	1.508,00	1.642,00	1.820,00
		<b>21</b>	1.350,00	1.455,00	1.534,00	1.672,00	1.849,00
		<b>09 - 14 - 39</b>	1.501,00	1.606,00	1.688,00	1.828,00	2.008,00
<b>SN 88 ... SN 97</b> (1)	+ 30 mm adjustability on item code measure	<b>31</b>	1.515,00	1.634,00	1.724,00	1.883,00	2.082,00
		<b>21</b>	1.543,00	1.662,00	1.755,00	1.910,00	2.113,00
		<b>09 - 14 - 39</b>	1.712,00	1.830,00	1.931,00	2.088,00	2.294,00
<b>SN 98 ... SN 107</b> (1)	+ 30 mm adjustability on item code measure	<b>31</b>	1.582,00	1.713,00	1.810,00	1.989,00	2.201,00
		<b>21</b>	1.606,00	1.737,00	1.840,00	2.019,00	2.232,00
		<b>09 - 14 - 39</b>	1.782,00	1.913,00	2.026,00	2.206,00	2.422,00
<b>SN 108 ... SN 117</b> (1)	+ 30 mm adjustability on item code measure	<b>31</b>	1.645,00	1.789,00	1.899,00	2.099,00	2.323,00
		<b>21</b>	1.668,00	1.813,00	1.926,00	2.126,00	2.351,00
		<b>09 - 14 - 39</b>	1.854,00	1.998,00	2.118,00	2.321,00	2.547,00
<b>SN 118 ... SN 129</b> (1)	+ 30 mm adjustability on item code measure	<b>31</b>	1.709,00	1.869,00	1.987,00	2.206,00	2.441,00
		<b>21</b>	1.735,00	1.895,00	2.016,00	2.236,00	2.472,00
		<b>09 - 14 - 39</b>	1.927,00	2.087,00	2.214,00	2.438,00	2.675,00

(1) Price includes 1 fixing bracket (fixing bracket "Q").

**OPTIONS - For customized solutions the additional costs have to be applied on made to measure prices**

<b>Glass</b>	<b>TPA</b>	144,00	treatment preventing limescale TPA Virgola included
	<b>Screen print</b>	200,00	decors: D50 D51 D52 D54 D55 D60 D61
	<b>Personal Glass</b>	294,00	decors: P13 P15 P16 P19 P32 P56 P70
<b>Profiles</b>	<b>Aluminium magnetic profile</b>	105,00	magnetic strip in aluminium profile
	<b>32</b>	+ 20%	on bright silver 21
	<b>05÷15 / 23 / 33 / 38 / 73 / 84</b>	+ 25%	on bright silver 21
<b>Special sizes</b>	<b>Lower height</b>	+ 5%	less than cm 196
	<b>Higher height</b>	+ 15%	higher height - max. cm 215
	<b>Higher height</b>	+ 30%	higher height - max. cm 230 - till door's dimension max cm. 55
	<b>Special width</b>	no extra charge	less than cm 68 (min cm 50)

**Custom solutions**

By connecting to the web page shown below, via QR code or by typing the address into your computer browser, you can get information on the custom solutions available for this model and the related additional costs. The examples are just indicative. Being customized solutions, it is necessary to submit an enquiry to our Technical Department so to check the feasibility and get an indication of the price.

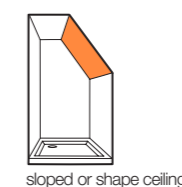

Product description

Shower enclosure for recessed shower trays larger than 98 cm. It consists of a pivot door hinged to a fixed panel plus a in line panel.

Characteristics

Outward opening door.

Adjustability 40 mm, obtained without the extension of the wall profile, which retains its aesthetic.

Double possibility of adjustment, lateral and longitudinal, upon completion of the installation, for an easy final adjustment before sealing.

PVC seals with magnetic strips. Items in matt black 09, moka 38 or metal gun 39 finishing are equipped with black seals.

S.M.F. (easily mounting system).

Product conforming to EN 14428:2018 with CE marking.

Materials

Tempered glass 6 mm for the door.  
Tempered glass 8 mm for the fix elements.

Anodised or enamelled aluminium profiles.

Unless specific requests, sintesi SM shower enclosures are supplied with standard hinges R61 and standard knob P3Q.



sintesi SM

glasses	04 clear glass	05 Timeless® anti-corrosion low maintenance glass. NO TPA available	03 clear bronze	01 obscure glass	06 reflecting
			07 clear grey	08 satin glass	10 extra-reflex
				11 katedral	14 satin extra-light
				12 extra-light	29 madras nuvola

MADE TO MEASURE

codes	dimension of recess	profiles	04	05	03	01	06
SM 98 ... SM 107 (1)	+ 40 mm adjustability on item code measure	31	1.669,00	1.669,00	1.926,00	2.110,00	2.341,00
		21	1.728,00	1.728,00	1.986,00	2.169,00	2.405,00
		09 - 14 - 39	1.919,00	1.919,00	2.183,00	2.370,00	2.609,00
SM 108 ... SM 117 (1)	+ 40 mm adjustability on item code measure	31	1.724,00	1.724,00	1.997,00	2.199,00	2.441,00
		21	1.780,00	1.780,00	2.058,00	2.261,00	2.504,00
		09 - 14 - 39	1.975,00	1.975,00	2.261,00	2.468,00	2.714,00
SM 118 ... SM 127 (1)	+ 40 mm adjustability on item code measure	31	1.777,00	1.777,00	2.071,00	2.295,00	2.542,00
		21	1.834,00	1.834,00	2.133,00	2.351,00	2.606,00
		09 - 14 - 39	2.037,00	2.037,00	2.345,00	2.563,00	2.823,00
SM 128 ... SM 137 (1)	+ 40 mm adjustability on item code measure	31	1.966,00	1.966,00	2.280,00	2.523,00	2.793,00
		21	2.020,00	2.020,00	2.340,00	2.582,00	2.859,00
		09 - 14 - 39	2.242,00	2.242,00	2.574,00	2.816,00	3.097,00
SM 138 ... SM 157 (1)	+ 40 mm adjustability on item code measure	31	2.051,00	2.051,00	2.410,00	2.682,00	2.969,00
		21	2.109,00	2.109,00	2.466,00	2.743,00	3.038,00
		09 - 14 - 39	2.344,00	2.344,00	2.713,00	2.990,00	3.286,00
SM 158 ... SM 179 (1)	+ 40 mm adjustability on item code measure	31	2.173,00	2.173,00	2.570,00	2.886,00	3.190,00
		21	2.232,00	2.232,00	2.626,00	2.943,00	3.258,00
		09 - 14 - 39	2.476,00	2.476,00	2.883,00	3.201,00	3.520,00

(1) Price includes the two fixing brackets (fixing brackets "Q")



Technical specifications

Please always advise the exact dimensions of the recess X and specify if left SX or right DX opening.

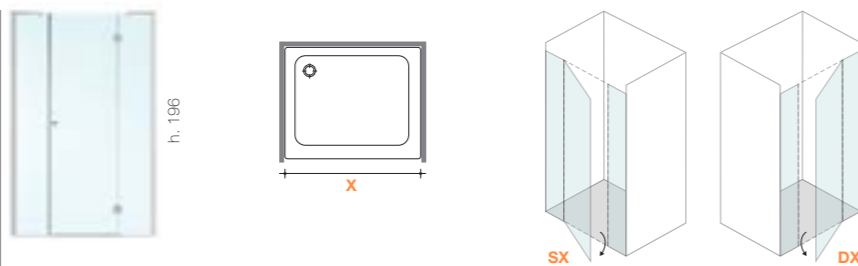

article	boxes	dimension of recess X	opening
serie Sintesi SM 98÷127	2	Sintesi SM is always custom made (cm by cm).  Ex: SN 105 = shower enclosure for recess from cm 105 to cm 109	The dimension of the door is approximately 1/2 of the recess and corresponds to the opening space (max 61 cm.)
SM 128÷179	3		

**ATTENTION:** Sintesi shower enclosures are designed to be installed on a standard shower tray. In the case of installation on the floor or on special shower trays that may need a custom size, the installation layout sheet (see pages 338-339) must be complete and attached to the order.

OPTIONS

Options	Price	Description
Glass	TPA	205,00 treatment preventing limescale TPA Virgola included
	Screen print	222,00 decors: D50 D51 D52 D54 D55 D60 D61
	Personal Glass	333,00 decors: P13 P15 P16 P19 P32 P56 P70
Profiles	Aluminium magnetic profile	211,00 magnetic strips in aluminium profile
	32	+ 20% on bright silver 21
	05÷15 / 23 / 33 / 38 / 73 / 84	+ 25% on bright silver 21
Special sizes	Lower height	+ 5% less than cm 196
	Higher height	+ 15% higher height - max. cm 215
	Higher height	+ 30% higher height - max. cm 230 - till door's dimension max cm. 80

Custom solutions

By connecting to the web page shown below, via QR code or by typing the address into your computer browser, you can get information on the custom solutions available for this model and the related additional costs. The examples are just indicative. Being customized solutions, it is necessary to submit an enquiry to our Technical Department so to check the feasibility and get an indication of the price.



[vism.it/L/S/LSSM.pdf](https://www.sintesi.com/it/L/S/LSSM.pdf)

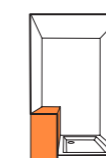

low wall in alignment to the door

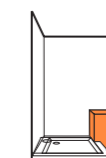

shaped wall

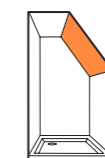

sloped or shape ceiling



shower element compatible with the need of people with reduced mobility

**Product description**

Frameless shower door; it can be assembled with a fix panel SF or with another SA to obtain a corner shower enclosure.

**Characteristics**

Outward opening door.

Adjustability 20 mm, obtained without the extension of the wall profile, which retains its aesthetic.

Double possibility of adjustment, lateral and longitudinal, upon completion of the installation, for an easy final adjustment before sealing.

PVC seals with magnetic strips. Items in matt black 09, moka 38 or metal gun 39 finishing are equipped with black seals.

**S.M.F.**  
(easily mounting system).

Product conforming to EN 14428:2018 with CE marking.

**Materials**

Tempered glass 6 mm for the door.  
Tempered glass 8 mm for the fix element.

Anodised or enamelled aluminium profiles.

Unless specific requests, **sintesi SA** shower enclosures are supplied with standard hinges **R61** and standard knob **P3Q**.



**Technical specifications**

Please, always advise the exact dimensions of the installed shower tray and specify if left **SX** or right **DX** opening.

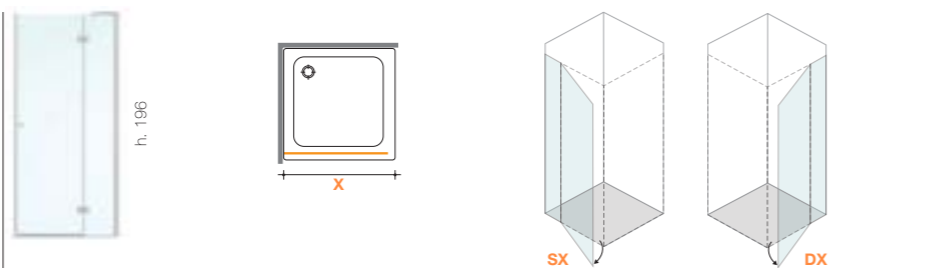

article	boxes	dimension of the installed shower tray X	opening
serie Sintesi SA 68÷95 SA 96÷129	1 2	Sintesi SA is always custom made (cm by cm).  Ex: SA 82 = shower enclosure for installed shower tray from cm 82 to cm 844.	The dimension of the door is approximately 2/3 of the shower tray and corresponds to the opening space (max 61 cm.)

**ATTENTION:** Sintesi shower enclosures are designed to be installed on a standard shower tray. In the case of installation on the floor or on special shower trays that may need a custom size, the installation layout sheet (see pages 338-339) must be complete and attached to the order.

sintesi  
SA

**STANDARD DIMENSIONS**

codes	dimension of shower tray	profiles	04 clear glass	04 + TPA Treatment preventing limescale TPA Virgola included
SA 68	68-70	21 bright silver	1.036,00	1.169,00
SA 78	78-80	21 bright silver	1.087,00	1.220,00
SA 88	88-90	21 bright silver	1.244,00	1.377,00
SA 98	98-100	21 bright silver	1.300,00	1.433,00
SA 108	108-110	21 bright silver	1.352,00	1.485,00
SA 118	118-120	21 bright silver	1.411,00	1.544,00

**ATTENTION**  
the model SA in standard dimensions can be combined exclusively with an element SF or to another element SA.

Quick delivery items.

**MADE TO MEASURE**

codes	dimension of shower tray	profiles	04 clear glass	05 Timeless® anti-corrosion low maintenance glass. NO TPA available	03 clear bronze	01 obscure glass	06 reflecting
SA 68 ... SA 77 (1)	+ 20 mm adjustability on item code measure	31	1.108,00	1.201,00	1.253,00	1.372,00	1.518,00
		21	1.129,00	1.222,00	1.280,00	1.395,00	1.548,00
		09 - 14 - 39	1.255,00	1.349,00	1.409,00	1.527,00	1.683,00
SA 78 ... SA 87 (1)	+ 20 mm adjustability on item code measure	31	1.169,00	1.274,00	1.338,00	1.476,00	1.637,00
		21	1.191,00	1.296,00	1.361,00	1.501,00	1.665,00
		09 - 14 - 39	1.323,00	1.429,00	1.500,00	1.639,00	1.804,00
SA 88 ... SA 97 (1)	+ 20 mm adjustability on item code measure	31	1.323,00	1.442,00	1.516,00	1.673,00	1.851,00
		21	1.353,00	1.472,00	1.548,00	1.707,00	1.885,00
		09 - 14 - 39	1.502,00	1.621,00	1.703,00	1.863,00	2.044,00
SA 98 ... SA 107 (1)	+ 20 mm adjustability on item code measure	31	1.384,00	1.515,00	1.603,00	1.785,00	1.972,00
		21	1.413,00	1.544,00	1.636,00	1.814,00	2.007,00
		09 - 14 - 39	1.567,00	1.698,00	1.798,00	1.978,00	2.174,00
SA 108 ... SA 117 (1)	+ 20 mm adjustability on item code measure	31	1.447,00	1.592,00	1.689,00	1.893,00	2.097,00
		21	1.474,00	1.618,00	1.721,00	1.925,00	2.133,00
		09 - 14 - 39	1.638,00	1.783,00	1.890,00	2.095,00	2.305,00
SA 118 ... SA 129 (1)	+ 20 mm adjustability on item code measure	31	1.507,00	1.667,00	1.775,00	2.005,00	2.217,00
		21	1.540,00	1.699,00	1.808,00	2.036,00	2.250,00
		09 - 14 - 39	1.709,00	1.869,00	1.986,00	2.217,00	2.433,00

(1) Price includes 1 fixing bracket (fixing bracket "Q").

**OPTIONS - For customized solutions the additional costs have to be applied on made to measure prices**

Category	Option	Price	Description
Glass	TPA	144,00	treatment preventing limescale TPA Virgola included
	Screen print	200,00	decors: D50 D51 D52 D54 D55 D60 D61
	Personal Glass	294,00	decors: P13 P15 P16 P19 P32 P56 P70
Profiles	Aluminium magnetic profile	105,00	magnetic strip in aluminium profile
	32	+ 20%	on bright silver 21
	05 ÷ 15 / 23 / 33 / 38 / 73 / 84	+ 25%	on bright silver 21
Special sizes	Lower height	+ 5%	less than cm 196
	Higher height	+ 15%	higher height - max. cm 215
	Higher height	+ 30%	higher height - max. cm 230 - till door's dimension max cm. 80
	Special width	+ 10% on SA 68	less than cm 68 (min cm 55)

**Custom solutions** By connecting to the web page shown below, via QR code or by typing the address into your computer browser, you can get information on the custom solutions available for this model and the related additional costs. The examples are just indicative. Being customized solutions, it is necessary to submit an enquiry to our Technical Department so to check the feasibility and get an indication of the price.



[vism.it/LS/LSSA.pdf](http://vism.it/LS/LSSA.pdf)

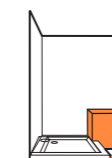

shaped wall



sloped or shape ceiling



shower element compatible with the need of people with reduced mobility

**Product description**

Fixed panel to be combined with the door SA to obtain a corner shower enclosure.

**Characteristics**

Adjustability **20 mm**, obtained without the extension of the wall profile, which retains its aesthetic.

Double possibility of adjustment, lateral and longitudinal, upon completion of the installation, for an easy final adjustment before sealing.

PVC seals with magnetic strips. Items in matt black **09**, moka **38** or metal gun **39** finishing are equipped with black seals.

**S.M.F.** (easily mounting system).

Product conforming to EN 14428:2018 with **CE** marking.

**Materials**

Tempered glass 8 mm.  
Anodised or enamelled aluminium profiles.



**Technical specifications**

**Please, always advise the exact dimensions of the installed shower tray and specify if left SX or right DX to the door.**

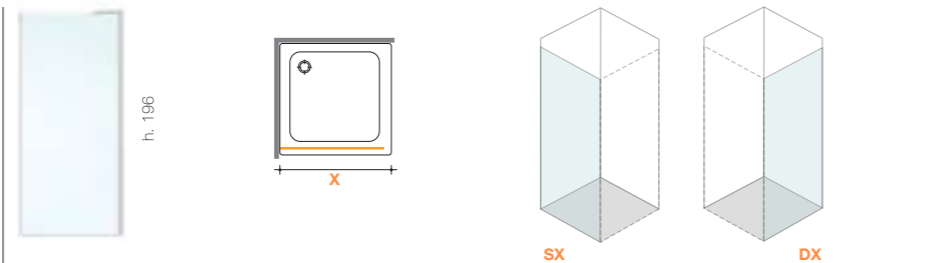

article	boxes	dimension of the installed shower tray X
serie Sintesi <b>SF 68÷107</b> <b>SF 108÷139</b>	1 2	Sintesi SF is always custom made (cm by cm).  Ex: <b>SF 85</b> = shower enclosure for installed shower tray from cm 85 to cm 87

**ATTENTION:** Sintesi shower enclosures are designed to be installed on a standard shower tray. In the case of installation on the floor or on special shower trays that may need a custom size, the installation layout sheet (see pages 338-339) must be complete and attached to the order.

sintesi  
**SF**

**STANDARD DIMENSIONS**

codes	dimension of shower tray	profiles	glasses	
<b>SF 68</b>	68-70	<b>21</b> bright silver	<b>04</b> clear glass	<b>04 + TPA</b> Treatment preventing limescale TPA Virgola included
<b>SF 78</b>	78-80	<b>21</b> bright silver		
<b>SF 88</b>	88-90	<b>21</b> bright silver		
<b>SF 98</b>	98-100	<b>21</b> bright silver		
<b>SF 108</b>	108-110	<b>21</b> bright silver		
<b>SF 118</b>	118-120	<b>21</b> bright silver		

**ATTENTION**  
the model **SF** in standard dimensions can be combined exclusively with an element **SA**

**Quick delivery items.**

**MADE TO MEASURE**

codes	dimension of shower tray	profiles	<b>04</b> clear glass	<b>05</b> Timeless® anti-corrosion low maintenance glass. NO TPA available	<b>03</b> clear bronze <b>07</b> clear grey	<b>01</b> obscure glass <b>08</b> satin glass <b>11</b> katedral <b>12</b> extra-light	<b>06</b> reflecting <b>10</b> extra-reflex <b>14</b> satin extra-light <b>29</b> madras nuvola
<b>SF 68 ... SF 77</b> (1)	+ 20 mm adjustability on item code measure	<b>31</b>	688,00	781,00	814,00	952,00	1.058,00
		<b>21</b>	703,00	796,00	830,00	969,00	1.077,00
		<b>09 - 14 - 39</b>	781,00	875,00	911,00	1.050,00	1.161,00
<b>SF 78 ... SF 87</b> (1)	+ 20 mm adjustability on item code measure	<b>31</b>	744,00	849,00	911,00	1.058,00	1.173,00
		<b>21</b>	759,00	865,00	927,00	1.073,00	1.189,00
		<b>09 - 14 - 39</b>	835,00	940,00	1.005,00	1.150,00	1.267,00
<b>SF 88 ... SF 97</b> (1)	+ 20 mm adjustability on item code measure	<b>31</b>	844,00	962,00	1.036,00	1.210,00	1.340,00
		<b>21</b>	868,00	987,00	1.060,00	1.235,00	1.369,00
		<b>09 - 14 - 39</b>	958,00	1.077,00	1.150,00	1.325,00	1.459,00
<b>SF 98 ... SF 107</b> (1)	+ 20 mm adjustability on item code measure	<b>31</b>	906,00	1.037,00	1.120,00	1.318,00	1.456,00
		<b>21</b>	930,00	1.061,00	1.146,00	1.343,00	1.489,00
		<b>09 - 14 - 39</b>	1.026,00	1.157,00	1.240,00	1.440,00	1.584,00
<b>SF 108 ... SF 117</b> (2) (3) (4)	+ 20 mm adjustability on item code measure	<b>31</b>	1.071,00	1.215,00	1.312,00	1.533,00	1.693,00
		<b>21</b>	1.093,00	1.238,00	1.338,00	1.557,00	1.723,00
		<b>09 - 14 - 39</b>	1.203,00	1.348,00	1.451,00	1.669,00	1.834,00
<b>SF 118 ... SF 139</b> (2) (3) (4)	+ 20 mm adjustability on item code measure	<b>31</b>	1.187,00	1.359,00	1.451,00	1.693,00	1.875,00
		<b>21</b>	1.213,00	1.385,00	1.481,00	1.723,00	1.906,00
		<b>09 - 14 - 39</b>	1.333,00	1.505,00	1.605,00	1.847,00	2.031,00

(1) Price includes one fixing bracket (fixing bracket "Q").

(2) Price includes one stabiliser rod (stabiliser rod "R").

(3) Packed in a wooden box, with no extra cost

(4) For a correct installation, whenever it's possible, we recommend to use the stabiliser rod R+J, to structurally connect the fix part to the door (see pag. 331 - rod R-J)

**OPTIONS - For customized solutions the additional costs have to be applied on made to measure prices**

<b>Parete radiante heating panel</b>		see pages 318 ÷ 321 for information and prices
<b>External towel holder</b>		see page 326 for information and prices
<b>Glass</b>	<b>TPA</b>	105,00 from SF 68 to SF 97 - treatment preventing limescale TPA
	<b>TPA</b>	150,00 from SF 98 to SF 139 - treatment preventing limescale TPA
	<b>Screen print</b>	144,00 decors: D50 D51 D52 D54 D55 D60 D61
	<b>Personal Glass</b>	222,00 decors: P13 P15 P16 P19 P32 P56 P70
	<b>Profiles</b>	<b>Aluminium magnetic profile</b> <b>32</b> <b>05÷15 / 23 / 33 / 38 / 73 / 84</b>
<b>Special sizes</b>	<b>Lower height</b>	+ 5% less than cm 196
	<b>Higher height</b>	+ 15% higher height - max. cm 215
	<b>Higher height</b>	+ 30% higher height - max. cm 230 - till max SF 119
	<b>Special width</b>	no extra charge less than cm 68 (min cm 30)

**Custom solutions**

By connecting to the web page shown below, via QR code or by typing the address into your computer browser, you can get information on the custom solutions available for this model and the related additional costs. The examples are just indicative. Being customized solutions, it is necessary to submit an enquiry to our Technical Department so to check the feasibility and get an indication of the price.



[vism.it/LS/LSSF.pdf](http://vism.it/LS/LSSF.pdf)

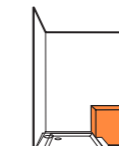

shaped wall

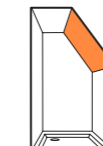

sloped or shape ceiling

**Product description**

Additional fixed panel for corner or three sided shower enclosure.

**Characteristics**

Adjustability **20** mm, obtained without the extension of the wall profile, which retains its aesthetic.

Double possibility of adjustment, lateral and longitudinal, upon completion of the installation, for an easy final adjustment before sealing.

It can be assembled to SA-SN-SM.

**S.M.F.** (easily mounting system).

Product conforming to EN 14428:2018 with **CE** marking.

**Materials**

Tempered glass 8 mm.  
Anodised or enamelled aluminium profiles.



**Technical specifications**

Please, always advise the exact dimensions of the installed shower tray and specify if left **SX** or right **DX** to the door

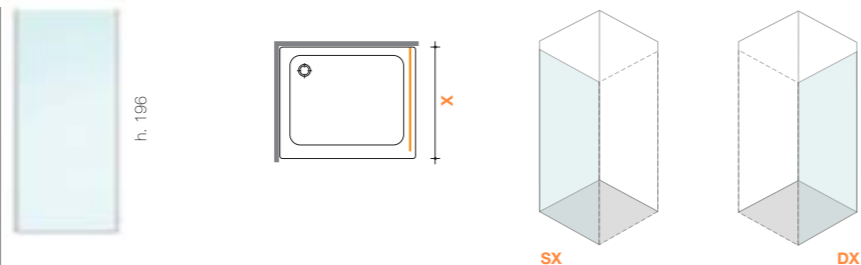

article	boxes	dimension of the installed shower tray X
serie Sintesi		
<b>SG 68-107</b>	1	Sintesi SG is always custom made (cm by cm).
<b>SG 108-119</b>	2	
		Ex: <b>SG 85</b> = shower enclosure for installed shower tray from cm 85 to cm 87

**ATTENTION:** Sintesi shower enclosures are designed to be installed on a standard shower tray. In the case of installation on the floor or on special shower trays that may need a custom size, the installation layout sheet (see pages 338-339) must be complete and attached to the order.

sintesi  
SG

**MADE TO MEASURE**

codes	dimension of shower tray	profiles	glasses	04 clear glass	05 Timeless® anti-corrosion low maintenance glass. NO TPA available	03 clear bronze	07 clear grey	01 obscure glass	08 satin glass	11 kathedral	12 extra-light	06 reflecting	10 extra-reflex	14 satin extra-light	29 madras nuvola
<b>SG 68 ... SG 77</b> (1)	+ 20 mm adjustability on item code measure	31		820,00	914,00	960,00	1.077,00	1.182,00							
		21		857,00	950,00	1.001,00	1.117,00	1.228,00							
		09 - 14 - 39		950,00	1.043,00	1.100,00	1.217,00	1.328,00							
<b>SG 78 ... SG 87</b> (1)	+ 20 mm adjustability on item code measure	31		872,00	978,00	1.030,00	1.171,00	1.288,00							
		21		908,00	1.013,00	1.073,00	1.210,00	1.329,00							
		09 - 14 - 39		1.008,00	1.113,00	1.177,00	1.314,00	1.435,00							
<b>SG 88 ... SG 97</b> (1)	+ 20 mm adjustability on item code measure	31		922,00	1.041,00	1.106,00	1.267,00	1.394,00							
		21		962,00	1.081,00	1.142,00	1.303,00	1.436,00							
		09 - 14 - 39		1.067,00	1.185,00	1.253,00	1.416,00	1.550,00							
<b>SG 98 ... SG 107</b> (2)	+ 20 mm adjustability on item code measure	31		1.062,00	1.193,00	1.272,00	1.456,00	1.603,00							
		21		1.058,00	1.189,00	1.314,00	1.501,00	1.651,00							
		09 - 14 - 39		1.177,00	1.308,00	1.435,00	1.625,00	1.777,00							
<b>SG 108 ... SG 119</b> (2) (3)	+ 20 mm adjustability on item code measure	31		1.152,00	1.296,00	1.381,00	1.582,00	1.742,00							
		21		1.202,00	1.346,00	1.427,00	1.633,00	1.794,00							
		09 - 14 - 39		1.336,00	1.481,00	1.567,00	1.773,00	1.937,00							

(1) The fixing bracket is recommended (by separate order) (fixing bracket "Q").  
 (2) A stabiliser rod is recommended (by separate order) (stabiliser rod "R").  
 (3) Packed in a wooden box, with no extra cost

**OPTIONS**

<b>Parete radiante heating panel</b>	see pages 318 - 321 for information and prices	
<b>External towel holder</b>	<b>PST - PSR</b> see page 326 for information and prices	
<b>Glass</b>	<b>TPA</b>	105,00 from SG 68 to SG 97 - treatment preventing limescale TPA
	<b>TPA</b>	150,00 from SG 98 to SG 119 - treatment preventing limescale TPA
	<b>Screen print</b>	144,00 decors: D50 D51 D52 D54 D55 D60 D61
	<b>Personal Glass</b>	222,00 decors: P13 P15 P16 P19 P32 P56 P70
<b>Profiles</b>	<b>32</b>	+ 20% on bright silver 21
	<b>05-15 / 23 / 33 / 38 / 73 / 84</b>	+ 25% on bright silver 21
<b>Special sizes</b>	<b>Lower height</b>	+ 5% less than cm 196
	<b>Higher height</b>	+ 15% higher height - max. cm 215
	<b>Higher height</b>	+ 30% higher height - max. cm 230 - till max SG 99
	<b>Special width</b>	no extra charge less than cm 68 (min cm 30)

**Custom solutions** By connecting to the web page shown below, via QR code or by typing the address into your computer browser, you can get information on the custom solutions available for this model and the related additional costs. The examples are just indicative. Being customized solutions, it is necessary to submit an enquiry to our Technical Department so to check the feasibility and get an indication of the price.



[vism.it/LS/LSSG.pdf](https://vism.it/LS/LSSG.pdf)

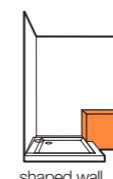

**Product description**

Fixed panel SP for installations on a bath tub or on a low wall.

**Characteristics**

Adjustability **20** mm.

Double possibility of adjustment, lateral and longitudinal.

To be assembled with door SN SM.

Product conforming to EN 14428:2018 with **CE** marking.

**Materials**

Tempered glass 8 mm.

Anodised or enamelled aluminium profiles.



**Technical specifications**

The SP panel is always custom made. Please advise the correct dimensions (width and height) and specify if left **SX** or right **DX** to the door.

Please always attach to the order sheet the technical drawing (from page 340 to page 343).

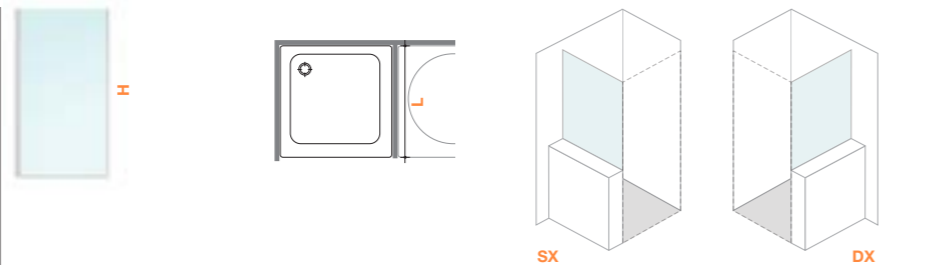

article	boxes	dimension L	dimension H
serie Sintesi <b>SP 140</b>	1	from 60 to 100	from 100 to 170

**Product compatibility with Flare collection.**

SP model can also be used for small wall configurations for **Flare** collection. In this case it takes the code **FP** instead of **SP**, but technically the product is identical.

sintesi  
**SP**

glasses

<b>04</b> clear glass	<b>05</b> Timeless® anti-corrosion low maintenance glass. <b>NO TPA</b> available	<b>03</b> clear bronze	<b>01</b> obscure glass	<b>06</b> reflecting
		<b>07</b> clear grey	<b>08</b> satin glass	<b>10</b> extra-reflex
			<b>11</b> cathedral	<b>14</b> satin extra-light
			<b>12</b> extra-light	<b>29</b> madras nuvola

**MADE TO MEASURE**

codes	dimensions	profiles	glasses				
<b>SP 140</b>	+ 20 mm adjustability on item code measure	<b>31</b>	780,00	877,00	896,00	996,00	1.096,00
		<b>21</b>	821,00	918,00	940,00	1.037,00	1.138,00
		<b>09 - 14 - 39</b>	911,00	1.008,00	1.033,00	1.130,00	1.233,00

**OPTIONS**

<b>Glass</b>	<b>TPA</b>	89,00	treatment preventing limescale TPA
	<b>Screen print</b>	133,00	decors: D50 D51 D52 D54 D55 D60 D61
	<b>Personal Glass</b>	200,00	decors: P19 P32 P70
<b>Profiles</b>	<b>32</b>	+ 20%	on bright silver 21
	<b>05 ÷ 15 / 23 / 33 / 38 / 73 / 84</b>	+ 25%	on bright silver 21
<b>Special sizes</b>			

**Custom solutions**

By connecting to the web page shown below, via QR code or by typing the address into your computer browser, you can get information on the custom solutions available for this model and the related additional costs. The examples are just indicative. Being customized solutions, it is necessary to submit an enquiry to our Technical Department so to check the feasibility and get an indication of the price.



[vism.it/L/S/LSSP.pdf](http://vism.it/L/S/LSSP.pdf)

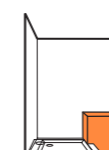

shaped wall



sloped or shape ceiling

**Product description**

Frameless shower enclosure with pivot door for pentagonal trays.

**Characteristics**

Adjustability **20** mm each side, obtained without the extension of the wall profile, which retains its aesthetic.

Double possibility of adjustment, lateral and longitudinal, upon completion of the installation, for an easy final adjustment before sealing.

Possibility to supply in special sizes.

Double possibility of adjustment, lateral and longitudinal.

PVC seals with magnetic strips. Items in matt black **09**, moka **38** or metal gun **39** finishing are equipped with black seals.

**S.M.F.**  
(easily mounting system).

Product conforming to EN 14428:2018 with **CE** marking.

**Materials**

Tempered glass 6 mm for the door.  
Tempered glass 8 mm for the fix elements.

Anodised or enamelled aluminium profiles.

Unless specific requests, **Sintesi TRS** shower enclosures are supplied with standard hinges **R65** and standard knob **P3Q**.



**Technical specifications**

Please always advise the exact dimension of the already installed shower tray and if left **SX** or right  **opening.**

Angles must always be 135°.

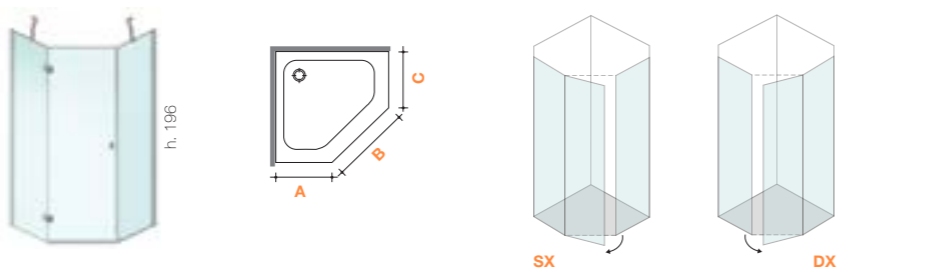

article	boxes	dimensions cm	opening	opening space cm
<b>TRS 90</b>	3	A 43,5÷45,5 B 64 C 43,5÷45,5	60	59



**ATTENTION:** Sintesi shower enclosures are designed to be installed on a standard shower tray. In the case of installation on the floor or on special shower trays that may need a custom size, the installation layout sheet (see pages 338-339) must be complete and attached to the order.

sintesi  
**TRS**

glasses

<b>04</b> clear glass	<b>05</b> Timeless® anti-corrosion low maintenance glass. <b>NO TPA</b> available	<b>03</b> clear bronze	<b>01</b> obscure glass	<b>06</b> reflecting
		<b>07</b> clear grey	<b>08</b> satin glass	<b>10</b> extra-reflex
			<b>11</b> cathedral	<b>14</b> satin extra-light
			<b>12</b> extra-light	<b>29</b> madras nuvola

**MADE TO MEASURE**

codes	dimension of shower tray	profiles					
<b>TRS 90</b> <b>(1)</b>		<b>31</b>	2.095,00	2.262,00	2.414,00	2.644,00	2.919,00
		<b>21</b>	2.151,00	2.319,00	2.472,00	2.701,00	2.979,00
		<b>09 - 14 - 39</b>	2.390,00	2.557,00	2.720,00	2.950,00	3.232,00

**(1)** Price includes 2 fixing brackets (fixing bracket "Q").

**OPTIONS**

<b>Glass</b>	<b>TPA</b>	233,00	treatment preventing limescale TPA Virgola included
	<b>Screen print</b>	222,00	decors: D50 D51 D52 D54 D55 D60 D61
	<b>Personal Glass</b>	333,00	decors: P13 P15 P16 P19 P32 P56 P70
<b>Profiles</b>	<b>Aluminium magnetic profile</b>	211,00	magnetic strips in aluminium profile
	<b>32</b>	+ 20%	on bright silver 21
	<b>05 ÷ 15 / 23 / 33 / 38 / 73 / 84</b>	+ 25%	on bright silver 21
	<b>Special sizes</b>	+ 5%	less than cm 196
<b>Special sizes</b>	<b>Lower height</b>	+ 5%	less than cm 196
	<b>Higher height</b>	+ 15%	higher height - max. cm 215
	<b>Higher height</b>	+ 30%	higher height - max. cm 230
<b>Special sizes</b>	<b>Special sizes</b>	+ 5%	

**Custom solutions**

By connecting to the web page shown below, via QR code or by typing the address into your computer browser, you can get information on the custom solutions available for this model and the related additional costs. The examples are just indicative. Being customized solutions, it is necessary to submit an enquiry to our Technical Department so to check the feasibility and get an indication of the price.



[vism.it/LS/LSTRS.pdf](https://vism.it/LS/LSTRS.pdf)

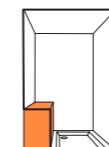

low wall in alignment to the door

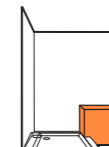

shaped wall

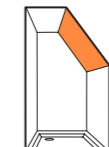

sloped or shape ceiling

**Product description**

Frameless quadrant shower enclosure for quadrant trays - Version with two doors  
ST: r. 55 cm.  
SH: r. 50 cm.

**Characteristics**

Outwards opening door (180°).

Extensible 20 mm each side.

Double possibility of adjustment, lateral and longitudinal.

Magnetic strips.

**S.M.F.**

(easily mounting system).

Product conforming to EN 14428:2018 with **CE** marking.

**Materials**

Tempered glass 6 mm for the doors.  
Tempered glass 8 mm for the fix elements.

Anodised or enamelled aluminium profiles.

Unless specific requests, **Sintesi ST-SH** shower enclosures are supplied with standard hinges **C80** and standard knob **P3T**.



**Technical specifications**

Suitable for quadrant shower trays R. 55 cm and R. 50 cm  
The radius of the quadrant shower tray must be checked by the customer.

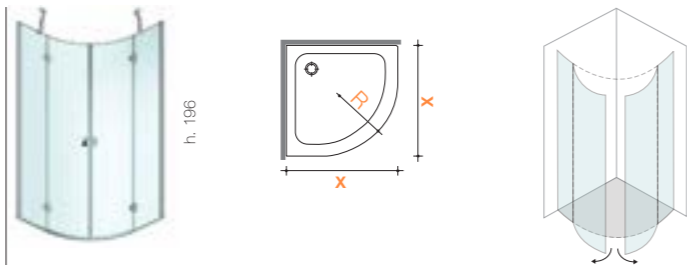

article	boxes	dimension of the installed shower tray X	opening	opening space cm	width fixed panels cm
serie Sintesi					
<b>ST 80</b>	2	78÷80 (R=55)	71	41	24
<b>ST 90</b>	2	88÷90 (R=55)	71	41	34
<b>SH 80</b>	2	78÷80 (R=50)	65	38	29
<b>SH 90</b>	2	88÷90 (R=50)	65	38	39



**ATTENTION:** Sintesi shower enclosures are designed to be installed on a standard shower tray. In the case of installation on the floor or on special shower trays that may need a custom size, the installation layout sheet (see pages 338-339) must be complete and attached to the order.

sintesi  
ST - SH

glasses

04 clear glass

08 satin glass

**STANDARD DIMENSIONS**

codes	dimension of shower tray	profiles		
<b>ST 80</b> (1)	shower tray from 78 to 80 cm	<b>31</b>	2.370,00	2.786,00
		<b>21</b>	2.419,00	2.840,00
		<b>09 - 14 - 39</b>	2.685,00	3.120,00
<b>ST 90</b> (1)	shower tray from 88 to 90 cm	<b>31</b>	2.490,00	2.954,00
		<b>21</b>	2.540,00	3.007,00
		<b>09 - 14 - 39</b>	2.821,00	3.301,00
<b>SH 80</b> (1)	shower tray from 78 to 80 cm	<b>31</b>	2.370,00	
		<b>21</b>	2.419,00	
		<b>09 - 14 - 39</b>	2.685,00	
<b>SH 90</b> (1)	shower tray from 88 to 90 cm	<b>31</b>	2.490,00	
		<b>21</b>	2.540,00	
		<b>09 - 14 - 39</b>	2.821,00	

(1) Price includes the two fixing brackets.

Quick delivery items

**OPTIONS**

<b>Glass</b>	<b>TPA</b>	294,00	treatment preventing limescale TPA Virgola included
	<b>Personal Glass</b>		not possible for this model
	<b>Screen print</b>		not possible for this model
<b>Profiles</b>	<b>32</b>	+ 20%	on bright silver 21
	<b>05÷15 / 23 / 33 / 38 / 73 / 84</b>	+ 25%	on bright silver 21
<b>Special sizes</b>	<b>Lower height</b>		NO special heights
	<b>Special width</b>	+ 10%	special width fixed panels

**Custom solutions**

By connecting to the web page shown below, via QR code or by typing the address into your computer browser, you can get information on the custom solutions available for this model and the related additional costs. The examples are just indicative. Being customized solutions, it is necessary to submit an enquiry to our Technical Department so to check the feasibility and get an indication of the price.



[vism.it/L/S/L/SST.pdf](http://vism.it/L/S/L/SST.pdf)

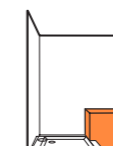

shaped wall



sloped or shape ceiling only fixed elements, NOT the door



replay  
collection



# replay

patented

**Replay** is a program of shower enclosures that features a door that usually folds inwards, but can open outwards if necessary. Replay can be used to create shower cabins in corners or in recess installation, both small and large.



The wall must be perpendicular to the door and the fixing base not less than 50 mm.

The installation system needs a free space of 10/12 cm above the shower enclosure to operate with a screw-driver.

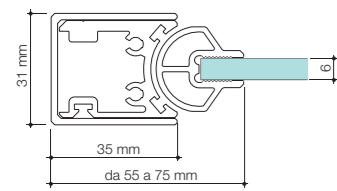

Used on model **RN RA RM**

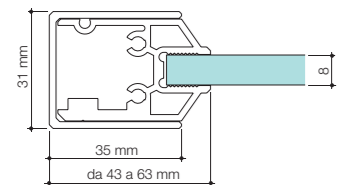

Used on model **RF RM RG**



profile system

disengage system

hinge



handle M5RS

SMF

The complete range of Vismaravetro profiles is available upon request at the e-mail [info@vismaravetro.it](mailto:info@vismaravetro.it)

replay  
type

recess



corner



quadrant

3-sided

side panel



Custom solutions

The collection Replay fits to special configurations and bespoke solutions (such as special cuttings for small walls or underroof, models for people with reduced mobility, hotel or residential contracts, solutions for shipbuilding). Please send your enquiry to our technical office at [info@vismaravetro.it](mailto:info@vismaravetro.it)

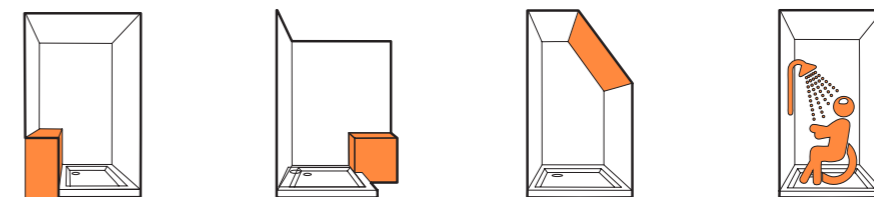

These examples are just indicative. Being customized solutions, it is necessary to submit an enquiry to our Technical Department so to check the feasibility and get an indication of the price.

**Product description**

Frameless shower enclosure with folding door for recessed shower tray.

**Characteristics**

Extensible **20** mm.  
Double possibility of adjustment, lateral and longitudinal, upon completion of the installation, for an easy final adjustment before sealing

Magnetic strips.  
Items in matt black **09**, moka **38** or metal gun **39** finishing are equipped with black seals.

The 2 hinged panels fold inwards sliding along the top rail

**S.M.F.**  
(easily mounting system).

The door can be quickly uncoupled and opened outwards

Product conforming to EN 14428:2018 with **CE** marking

**Materials**

Tempered glass 6 mm for the door  
Anodised or enamelled aluminium profiles



**Technical specifications**

Please always advise the exact dimensions of the recess **X** and specify if left **SX** or right  **opening.**

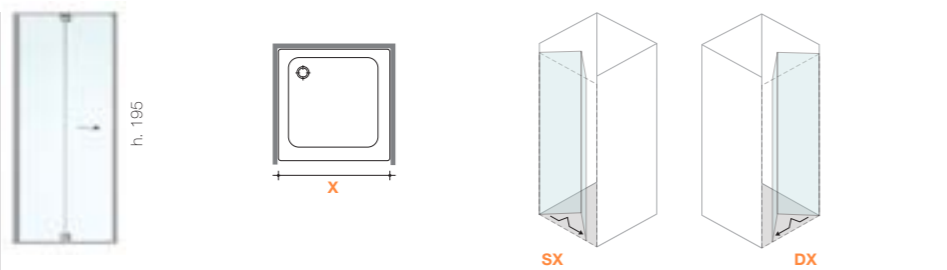

article	boxes	dimension of recess X	opening
<b>RN 68÷99</b>	1	Replay RN is always custom made (cm by cm).  Ex: <b>RN 78</b> = shower enclosure for recess from cm 78 to cm 80	The door has an opening approximately 15 cm less than the recess  Ex: recess 80 cm, opening 65 cm

**Important:** Replay shower enclosures are designed to be installed on a standard shower tray. In the case of installation on the floor or on special shower trays that may need a custom size, the **installation layout sheet** (see pages 338-339) must be complete and attached to the order.

<b>04</b> clear glass	<b>04 + TPA</b> Treatment preventing limescale TPA Virgola included			
-----------------------	--	--	--	--

**STANDARD DIMENSIONS**

codes	dimension of recess	profiles		
<b>RN 67</b>	67-69	<b>21</b> bright silver	<b>1.446,00</b>	<b>1.579,00</b>
<b>RN 77</b>	77-79	<b>21</b> bright silver	<b>1.495,00</b>	<b>1.628,00</b>
<b>RN 87</b>	87-89	<b>21</b> bright silver	<b>1.551,00</b>	<b>1.684,00</b>
<b>RN 97</b>	97-99	<b>21</b> bright silver	<b>1.603,00</b>	<b>1.736,00</b>

**! ATTENTION**  
the model RN in standard dimension cannot be combined with other elements

<b>04</b> clear glass	<b>05</b> Timeless® anti-corrosion low maintenance glass. NO TPA available	<b>03</b> clear bronze <b>07</b> clear grey	<b>01</b> obscure glass <b>08</b> satin glass <b>11</b> cathedral <b>12</b> extra-light	<b>06</b> reflecting <b>10</b> extra-reflex <b>14</b> satin extra-light <b>29</b> madras nuvola
-----------------------	--	--	--	--

**MADE TO MEASURE**

codes	dimension of recess	profiles					
<b>RN 68 ... RN 77</b>	+ 20 mm adjustability on item code measure	<b>14 - 31</b>	1.535,00	1.623,00	1.708,00	1.834,00	2.018,00
		<b>21</b>	1.633,00	1.721,00	1.809,00	1.935,00	2.129,00
		<b>09 - 39</b>	1.812,00	1.899,00	2.015,00	2.143,00	2.339,00
<b>RN 78 ... RN 87</b>	+ 20 mm adjustability on item code measure	<b>14 - 31</b>	1.593,00	1.694,00	1.786,00	1.931,00	2.126,00
		<b>21</b>	1.689,00	1.790,00	1.887,00	2.031,00	2.236,00
		<b>09 - 39</b>	1.875,00	1.976,00	2.101,00	2.246,00	2.455,00
<b>RN 88 ... RN 99</b>	+ 20 mm adjustability on item code measure	<b>14 - 31</b>	1.647,00	1.762,00	1.863,00	2.026,00	2.230,00
		<b>21</b>	1.745,00	1.859,00	1.962,00	2.127,00	2.339,00
		<b>09 - 39</b>	1.937,00	2.051,00	2.183,00	2.351,00	2.567,00

**OPTIONS - For customized solutions the additional costs have to be applied on made to measure prices**

<b>Glass</b>	<b>TPA</b>	144,00	treatment preventing limescale TPA Virgola included
	<b>Screen print</b>	155,00	decors: D50 D51 D52 D54 D55 D60 D61
	<b>Personal Glass</b>	244,00	decors: P13 P15 P16 P19 P32 P56 P70
<b>Profiles</b>	<b>32</b>	+ 20%	on bright silver 21
	<b>05÷15 / 23 / 33 / 38 / 84</b>	+ 25%	on bright silver 21
<b>Special sizes</b>	<b>Lower height</b>	+ 5%	less than cm 195
	<b>Higher height</b>	+ 15%	more than cm 195 (max. cm 215)
	<b>Special width</b>	+ 10% on RN 68	less than cm 68 (min cm 55)

**Custom solutions** By connecting to the web page shown below, via QR code or by typing the address into your computer browser, you can get information on the custom solutions available for this model and the related additional costs. The examples are just indicative. Being customized solutions, it is necessary to submit an enquiry to our Technical Department so to check the feasibility and get an indication of the price.



[vism.it/LS/LSRN.pdf](http://vism.it/LS/LSRN.pdf)

**Product description**

Frameless shower enclosure with folding door for recessed shower tray larger than 95 cm.

**Characteristics**

Extensible **20 mm** each side.

Double possibility of adjustment, lateral and longitudinal, upon completion of the installation, for an easy final adjustment before sealing

Magnetic strips. Items in matt black **09**, moka **38** or metal gun **39** finishing are equipped with black seals.

The 2 hinged panels fold inwards sliding along the top rail.

**S.M.F.**  
(easily mounting system).

The door can be quickly uncoupled and opened outwards.

Product conforming to EN 14428:2018 with **CE** marking

**Materials**

Tempered glass 6 mm for the door;  
Tempered glass 8 mm for the fix panel

Anodised or enamelled aluminium profiles



**Technical specifications**

Please always advise the exact dimensions of the recess **X** and specify if left **SX** or right **DX** opening.

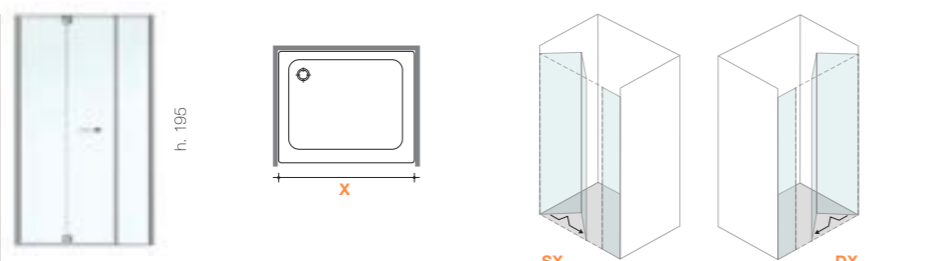

article	boxes	dimension of recess X	opening with standard door (cm)
RM 95÷107	2	Replay "RM" is always custom made (cm by cm).	65
RM 108÷117	2		65
RM 118÷127	2		75
RM 128÷137	2		75
RM 138÷147	2	Ex: <b>RM105</b> = shower enclosure for recess from cm 105 to cm 109.	75
RM 148÷159	2		75

**Important:** Replay shower enclosures are designed to be installed on a standard shower tray. In the case of installation on the floor or on special shower trays that may need a custom size, the **installation layout sheet** (see pages 338-339) must be complete and attached to the order.

**MADE TO MEASURE**

codes	dimension of recess	profiles	glasses					
			04 clear glass	05 Timeless® anti-corrosion low maintenance glass. NO TPA available	03 clear bronze	01 obscure glass	06 reflecting	07 clear grey
RM 95 ... RM 107	+ 40 mm adjustability on item code measure	<b>14 - 31</b>	2.304,00	2.442,00	2.595,00	2.775,00	3.050,00	
		<b>21</b>	2.408,00	2.545,00	2.698,00	2.879,00	3.167,00	
		<b>09 - 39</b>	2.672,00	2.809,00	3.004,00	3.188,00	3.480,00	
RM 108 ... RM 117	+ 40 mm adjustability on item code measure	<b>14 - 31</b>	2.367,00	2.517,00	2.682,00	2.894,00	3.185,00	
		<b>21</b>	2.468,00	2.618,00	2.788,00	2.999,00	3.300,00	
		<b>09 - 39</b>	2.742,00	2.893,00	3.101,00	3.318,00	3.623,00	
RM 118 ... RM 127	+ 40 mm adjustability on item code measure	<b>14 - 31</b>	2.425,00	2.589,00	2.771,00	3.013,00	3.313,00	
		<b>21</b>	2.531,00	2.694,00	2.877,00	3.119,00	3.430,00	
		<b>09 - 39</b>	2.811,00	2.974,00	3.198,00	3.444,00	3.763,00	
RM 128 ... RM 137	+ 40 mm adjustability on item code measure	<b>14 - 31</b>	2.492,00	2.668,00	2.860,00	3.115,00	3.425,00	
		<b>21</b>	2.591,00	2.767,00	2.966,00	3.217,00	3.541,00	
		<b>09 - 39</b>	2.876,00	3.053,00	3.294,00	3.551,00	3.881,00	
RM 138 ... RM 147	+ 40 mm adjustability on item code measure	<b>14 - 31</b>	2.738,00	2.928,00	3.148,00	3.425,00	3.767,00	
		<b>21</b>	2.848,00	3.038,00	3.265,00	3.541,00	3.895,00	
		<b>09 - 39</b>	3.161,00	3.351,00	3.625,00	3.908,00	4.268,00	
RM 148 ... RM 159	+ 40 mm adjustability on item code measure	<b>14 - 31</b>	2.986,00	3.190,00	3.433,00	3.736,00	4.109,00	
		<b>21</b>	3.109,00	3.313,00	3.558,00	3.862,00	4.248,00	
		<b>09 - 39</b>	3.454,00	3.659,00	3.956,00	4.264,00	4.656,00	

**OPTIONS**

<b>Glass</b>	<b>TPA</b>	205,00	treatment preventing limescale TPA Virgola included
	<b>Screen print</b>	222,00	decors: D50 D51 D52 D54 D55 D60 D61
	<b>Personal Glass</b>	333,00	decors: P13 P15 P16 P19 P32 P56 P70
<b>Profiles</b>	<b>32</b>	+ 20%	on bright silver 21
	<b>05÷15 / 23 / 33 / 38 / 84</b>	+ 25%	on bright silver 21
<b>Special sizes</b>	<b>Lower height</b>	+ 5%	less than cm 195
	<b>Higher height</b>	+ 15%	more than cm 195 (max. cm 215)
	<b>Special width panel</b>	+ 10%	special width fixed panel

**Custom solutions**

By connecting to the web page shown below, via QR code or by typing the address into your computer browser, you can get information on the custom solutions available for this model and the related additional costs. The examples are just indicative. Being customized solutions, it is necessary to submit an enquiry to our Technical Department so to check the feasibility and get an indication of the price.



[vism.it/LS/LSRM.pdf](https://vism.it/LS/LSRM.pdf)

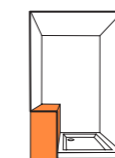

low wall in alignment to the door

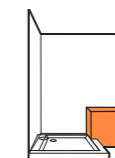

shaped wall

shower element compatible with the need of people with reduced mobility

**Product description**

Frameless shower enclosure with folding door to combine with fixed panel RF for corner tray.

Assembled to another RA element, it composes a corner shower enclosure that can be completely opened.

**Characteristics**

Extensible **20 mm**

Double possibility of adjustment, lateral and longitudinal, upon completion of the installation, for an easy final adjustment before sealing

Magnetic strips. Items in matt black **09**, moka **38** or metal gun **39** finishing are equipped with black seals.

The 2 hinged panels fold inwards sliding along the top rail

**S.M.F.** (easily mounting system).

The door can be quickly uncoupled and opened outwards

Product conforming to EN 14428:2018 with **CE** marking

**Materials**

Tempered glass 6 mm for the door

Anodised or enamelled aluminium profiles



**Technical specifications**

Please, always advise the exact dimensions of the installed shower tray and specify if left **SX** or right **DX** opening.X.

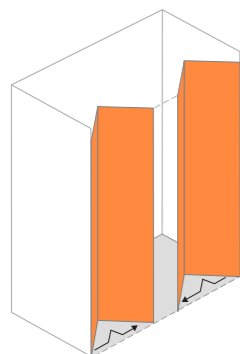

RA+RA elements, used in alignment, create a shower enclosure for a very large niche with almost total opening. Contact our Technical Service for feasibility and costs.

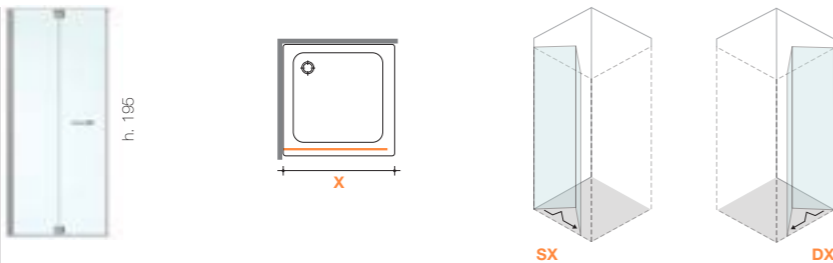

article	boxes	dimension of the installed shower tray X	opening
<b>RA 68÷99</b>	1	Replay RA is always custom made (cm by cm).  Ex: <b>RA 82</b> = shower enclosure for installed shower tray from cm 82 to cm 84	The door has an opening approximately 15 cm less than the measure of the shower tray  Ex: shower tray 80 cm, opening 65 cm

**Important:** Replay shower enclosures are designed to be installed on a standard shower tray. In the case of installation on the floor or on special shower trays that may need a custom size, the **installation layout sheet** (see pages 338-339) must be complete and attached to the order.

**STANDARD DIMENSIONS**

codes	dimension of shower tray	profiles		
<b>RA 68</b>	68-70	<b>21</b> bright silver	<b>1.309,00</b>	<b>1.442,00</b>
<b>RA 78</b>	78-80	<b>21</b> bright silver	<b>1.354,00</b>	<b>1.487,00</b>
<b>RA 88</b>	88-90	<b>21</b> bright silver	<b>1.403,00</b>	<b>1.536,00</b>
<b>RA 98</b>	98-100	<b>21</b> bright silver	<b>1.452,00</b>	<b>1.585,00</b>

**ATTENTION**  
the model RA in standard dimension can be combined exclusively with an element RF or to another element RA.

Quick delivery items.

**MADE TO MEASURE**

codes	dimension of shower tray	profiles					
<b>RA 68 ... RA 77</b>	+ 20 mm adjustability on item code measure	<b>14 - 31</b>	1.350,00	1.437,00	1.515,00	1.635,00	1.802,00
		<b>21</b>	1.423,00	1.511,00	1.593,00	1.714,00	1.886,00
		<b>09 - 39</b>	1.582,00	1.669,00	1.775,00	1.897,00	2.073,00
<b>RA 78 ... RA 87</b>	+ 20 mm adjustability on item code measure	<b>14 - 31</b>	1.403,00	1.504,00	1.591,00	1.732,00	1.904,00
		<b>21</b>	1.477,00	1.578,00	1.668,00	1.809,00	1.990,00
		<b>09 - 39</b>	1.638,00	1.739,00	1.857,00	1.999,00	2.182,00
<b>RA 88 ... RA 99</b>	+ 20 mm adjustability on item code measure	<b>14 - 31</b>	1.457,00	1.572,00	1.666,00	1.826,00	2.008,00
		<b>21</b>	1.531,00	1.645,00	1.744,00	1.904,00	2.095,00
		<b>09 - 39</b>	1.699,00	1.814,00	1.939,00	2.101,00	2.295,00

**OPTIONS - For customized solutions the additional costs have to be applied on made to measure prices**

<b>Glass</b>	<b>TPA</b>	144,00	treatment preventing limescale TPA Virgola included
	<b>Screen print</b>	155,00	decors: D50 D51 D52 D54 D55 D60 D61
	<b>Personal Glass</b>	244,00	decors: P13 P15 P16 P19 P32 P56 P70
<b>Profiles</b>	<b>32</b>	+ 20%	on bright silver 21
	<b>05÷15 / 23 / 33 / 38 / 84</b>	+ 25%	on bright silver 21
<b>Special sizes</b>	<b>Lower height</b>	+ 5%	less than cm 195
	<b>Higher height</b>	+ 15%	more than cm 195 (max. cm 215)
	<b>Special width</b>	+ 10% on RA 68	less than cm 68 (min cm 55)

**Custom solutions**

By connecting to the web page shown below, via QR code or by typing the address into your computer browser, you can get information on the custom solutions available for this model and the related additional costs. The examples are just indicative. Being customized solutions, it is necessary to submit an enquiry to our Technical Department so to check the feasibility and get an indication of the price.



[vism.it/LS/LSRA.pdf](http://vism.it/LS/LSRA.pdf)



shower element compatible with the need of people with reduced mobility



**Product description**

Additional fixed panel for corner shower enclosures.

**Characteristics**

Extensible 20 mm each side.

Horizontal and vertical adjustment.

It can be assembled to RM and RN

**S.M.F.**

(easily mounting system).

Product conforming to EN 14428:2018 with **CE** marking

**Materials**

Tempered glass 8 mm

Anodised or enamelled aluminium profiles



**Technical specifications**

Please, always advise the exact dimensions of the installed shower tray and specify if left **SX** or right **DX** to the door.

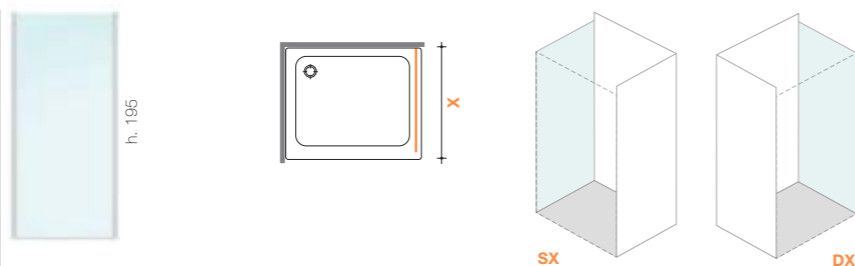

article	boxes	dimension of the installed shower tray X	
<b>RG 68÷119</b>	1	Replay RG is always custom made (cm by cm).	Ex: <b>RG 82</b> = shower enclosure for installed shower tray from cm 82 to cm 84

**Important:** Replay shower enclosures are designed to be installed on a standard shower tray. In the case of installation on the floor or on special shower trays that may need a custom size, the **installation layout sheet** (see pages 338-339) must be complete and attached to the order.

<b>04</b> clear glass	<b>05</b> Timeless® anti-corrosion low maintenance glass. NO TPA available	<b>03</b> clear bronze	<b>01</b> obscure glass	<b>06</b> reflecting
		<b>07</b> clear grey	<b>08</b> satin glass	<b>10</b> extra-reflex
			<b>11</b> cathedral	<b>14</b> satin extra-light
			<b>12</b> extra-light	<b>29</b> madras nuvola

**MADE TO MEASURE**

codes	dimension of shower tray	profiles					
<b>RG 68 ... RG 77</b>	+ 20 mm adjustability on item code measure	<b>14 - 31</b>	851,00	948,00	1.000,00	1.124,00	1.237,00
		<b>21</b>	896,00	992,00	1.051,00	1.173,00	1.290,00
		<b>09 - 39</b>	993,00	1.090,00	1.166,00	1.288,00	1.407,00
<b>RG 78 ... RG 87</b>	+ 20 mm adjustability on item code measure	<b>14 - 31</b>	902,00	1.011,00	1.073,00	1.217,00	1.338,00
		<b>21</b>	949,00	1.058,00	1.124,00	1.263,00	1.392,00
		<b>09 - 39</b>	1.055,00	1.163,00	1.244,00	1.389,00	1.518,00
<b>RG 88 ... RG 97</b>	+ 20 mm adjustability on item code measure	<b>14 - 31</b>	953,00	1.074,00	1.147,00	1.308,00	1.440,00
		<b>21</b>	1.000,00	1.121,00	1.193,00	1.355,00	1.490,00
		<b>09 - 39</b>	1.110,00	1.231,00	1.323,00	1.487,00	1.624,00
<b>RG 98 ... RG 107</b>	+ 20 mm adjustability on item code measure	<b>14 - 31</b>	1.048,00	1.182,00	1.263,00	1.440,00	1.586,00
		<b>21</b>	1.099,00	1.233,00	1.318,00	1.491,00	1.636,00
		<b>09 - 39</b>	1.222,00	1.356,00	1.456,00	1.635,00	1.785,00
<b>RG 108 ... RG 119 (1)</b>	+ 20 mm adjustability on item code measure	<b>14 - 31</b>	1.190,00	1.340,00	1.436,00	1.635,00	1.802,00
		<b>21</b>	1.252,00	1.402,00	1.495,00	1.694,00	1.863,00
		<b>09 - 39</b>	1.392,00	1.542,00	1.654,00	1.860,00	2.031,00

(1) Attention: Packed in wooden box with no extra costs

**OPTIONS**

<b>Parete radiante heating panel</b>		see pages 318 ÷ 321 for information and prices	
<b>External towel holder</b>		see page 326 for information and prices	
<b>Glass</b>	<b>TPA</b>	105,00	from RG 68 to RG 97 - treatment preventing limescale TPA
	<b>TPA</b>	150,00	from RG 98 to RG 119 - treatment preventing limescale TPA
	<b>Screen print</b>	144,00	decors: D50 D51 D52 D54 D55 D60 D61
	<b>Personal Glass</b>	222,00	decors: P13 P15 P16 P19 P32 P56 P70
<b>Profiles</b>	<b>32</b>	+ 20%	on bright silver 21
	<b>05÷15 / 23 / 33 / 38 / 84</b>	+ 25%	on bright silver 21
<b>Special sizes</b>	<b>Lower height</b>	+ 5%	less than cm 195
	<b>Higher height</b>	+ 15%	more than cm 195 (max. cm 215)
	<b>Special width</b>	no extra charge	less than cm 68 (min cm 30)

**Custom solutions**

By connecting to the web page shown below, via QR code or by typing the address into your computer browser, you can get information on the custom solutions available for this model and the related additional costs. The examples are just indicative. Being customized solutions, it is necessary to submit an enquiry to our Technical Department so to check the feasibility and get an indication of the price.



[vism.it/LS/LSRG.pdf](http://vism.it/LS/LSRG.pdf)

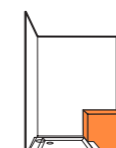

shaped wall

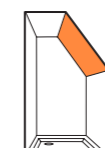

sloped or shape ceiling

**Product description**

Fixed panel RV for installations on a bath tub or on a low wall.

**Characteristics**

- Adjustability **20** mm.
- Horizontal and vertical adjustment
- Magnetic strips
- To be assembled with door RN-RM
- Product conforming to EN 14428:2018 with **CE** marking

**Materials**

- Tempered glass 8 mm
- Anodised or enamelled aluminium profiles.



**Technical specifications**

The RV panel is always custom made. Please advise the correct dimensions (width and height) and specify if left **SX** or right **DX** to the door.

Please always attach to the order sheet the technical drawing (from page 340 to page 343).

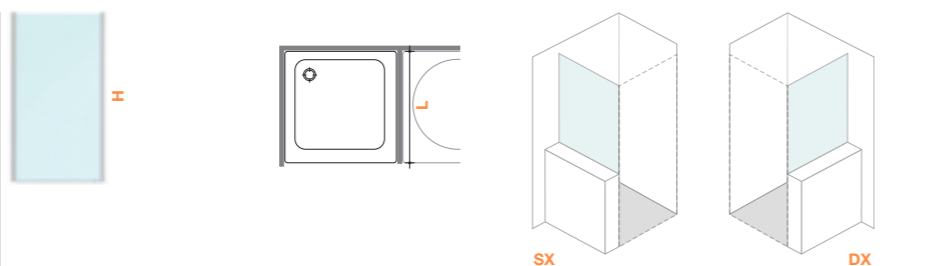

article	boxes	dimension L	dimension H
<b>RV</b>	1	from 60 to 100	from 100 to 170

glasses	<b>04</b> clear glass	<b>05</b> Timeless® anti-corrosion low maintenance glass. NO TPA available	<b>03</b> clear bronze	<b>01</b> obscure glass	<b>06</b> reflecting
			<b>07</b> clear grey	<b>08</b> satin glass	<b>10</b> extra-reflex
				<b>11</b> cathedral	<b>14</b> satin extra-light
				<b>12</b> extra-light	<b>29</b> madras nuvola

**MADE TO MEASURE**

codes	dimensions	profiles					
<b>RV 140</b>	+ 20 mm adjustability on item code measure	<b>14 - 31</b>	780,00	877,00	896,00	996,00	1.096,00
		<b>21</b>	821,00	918,00	940,00	1.037,00	1.138,00
		<b>09 - 39</b>	911,00	1.008,00	1.033,00	1.130,00	1.233,00

**OPTIONS**

<b>Glass</b>	<b>TPA</b>	89,00	Treatment preventing limescale TPA.
	<b>Screen print</b>	133,00	decors: D50 D51 D52 D54 D55 D60 D61
	<b>Personal Glass</b>	200,00	decors: P19 P32 P56 P70
<b>Profiles</b>	<b>32</b>	+ 20%	on bright silver 21
	<b>05÷15 / 23 / 33 / 38 / 84</b>	+ 25%	on bright silver 21
<b>Special sizes</b>			

**Custom solutions**

By connecting to the web page shown below, via QR code or by typing the address into your computer browser, you can get information on the custom solutions available for this model and the related additional costs. The examples are just indicative. Being customized solutions, it is necessary to submit an enquiry to our Technical Department so to check the feasibility and get an indication of the price.

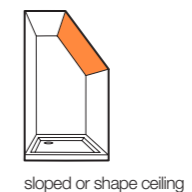
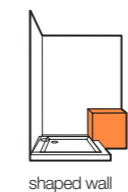

# serie 8000

collection



# serie 8000

**Serie 8000** is characterized by an essential and impeccable design, because of the great formal lightness and the tested stability. The use of the 8 mm tempered glass and the new design for the aluminium frame offer a powerful structure with a light design and a cost-effective offer.

A notable product, but perfect for everyday use, thanks to its exceptional water-proof performance and functionality, as a result of our long experience in manufacturing sliding shower enclosures.



The ball bearings run inside the top profile. They are hidden from view and well protected from dust and limescale, so to ensure the correct functionality.

The doors and the fixed panels are made of safety tempered glass 8 mm thickness. Waterproof is obtained thanks to the minimal distance between the two glasses and to the magnetic seals of the doors' glass.

The overlap between door and fixed glass is always kept to a minimum. Few millimeters of overlap are necessary to ensure correct door regulation.



Rollers with ball bearings



Magnetic seals. Items in matt black 09, moka 38 or metal gun 39 finishing are equipped with black seals.



M4S handle



Wall profile AS20

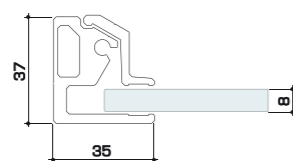

Upper rail



The door can be disengaged for an easy maintenance of the shower enclosure. The door can be moved inwards about 15 cm.

The complete range of Vismaravetro profiles is available upon request at the e-mail [info@vismaravetro.it](mailto:info@vismaravetro.it)

The wall must be perpendicular to the door and the fixing base not less than 50 mm.

The installation system needs a free space of 10/12 cm above the shower enclosure to operate with a screw-driver.

serie 8000  
type

recess



corner

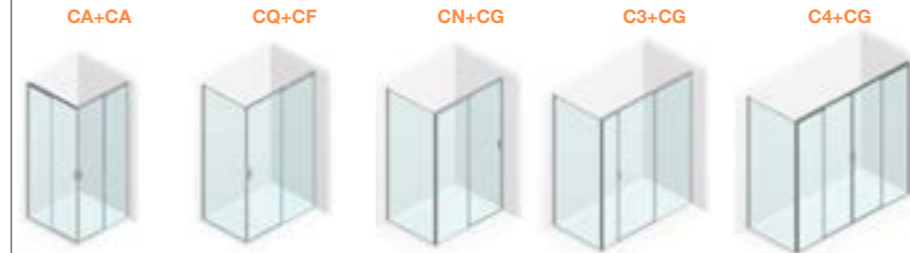

quadrant

3-sided

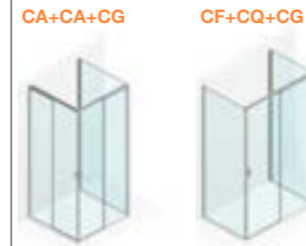

side panel



Custom solutions

The collection Serie 8000 fits to special configurations and bespoke solutions (such as special cuttings for small walls or underroof, models for people with reduced mobility, hotel or residential contracts, solutions for shipbuilding) Please send your enquiry to our technical office at [info@vismaravetro.it](mailto:info@vismaravetro.it)

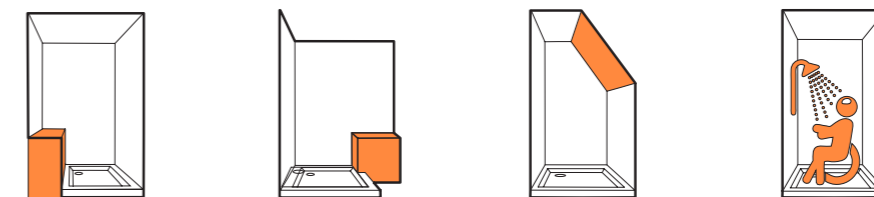

These examples are just indicative. Being customized solutions, it is necessary to submit an enquiry to our Technical Department so to check the feasibility and get an indication of the price.



**Product description**

Sliding shower enclosure, for built-in shower trays in recess.

**Characteristics**

Adjustability **10** mm,

Vertical PVC seals with magnetic strips. Items in matt black **09**, moka **38** or metal gun **39** finishing are equipped with black seals.

Door with releasable system.

**S.M.F.**  
(easy mounting system).

Product conforming to EN14428:2018 with **CE** marking.

**Materials**

Tempered glass 8 mm.

Anodised or enamelled aluminium profiles.



**Technical specifications**

Please always advise the exact dimensions of the recess **X**, the eventual overlap between wall and shower tray **y** and specify if **DX** right or **SX** left opening.

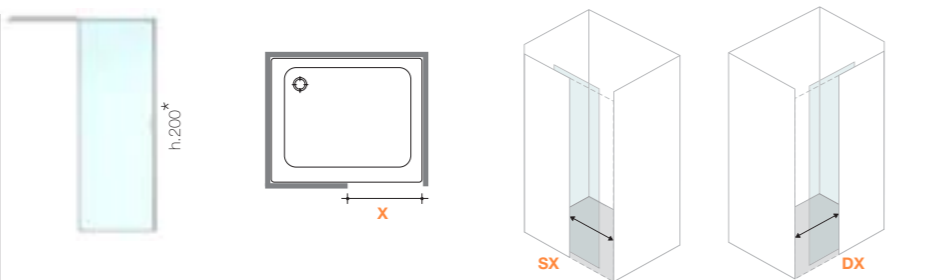
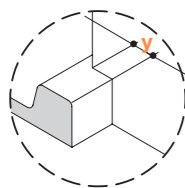

article	boxes	dimension of recess <b>X</b>	opening
<b>CL 48÷79</b>	1	Serie 8000 "CL" is always custom made (cm by cm).  Ex: <b>CL 68</b> = shower enclosure for recess between cm 68 and 69.	The dimension of the door is approximately 8 cm less than the recess.  Ex: recess 70 cm, opening 62 cm.

**ATTENTION:** Serie 8000 shower enclosures are designed to be installed on a standard shower tray. In the case of installation on the floor or on special shower trays that may need a custom size, the installation layout sheet (see pages 338-339) must be complete and attached to the order.

serie 8000  
**CL**

glasses

<b>04</b> clear glass	<b>05</b> Timeless® anti-corrosion low maintenance glass. NO TPA available	<b>03</b> clear bronze	<b>01</b> obscure glass	<b>06</b> reflecting
		<b>07</b> clear grey	<b>08</b> satin glass	<b>10</b> extra-reflex
			<b>11</b> cathedral	<b>14</b> satin extra-light
			<b>12</b> extra-light	<b>29</b> madras nuvola

**MADE TO MEASURE**

codes	dimension of recess	profiles					
<b>CL 48 ... CL 57</b>	+ 10 mm adjustability on item code measure	<b>31</b>	1.117,00	1.220,00	1.270,00	1.391,00	1.532,00
		<b>21</b>	1.140,00	1.243,00	1.296,00	1.417,00	1.557,00
		<b>09 - 14 - 39 - 61</b>	1.267,00	1.370,00	1.426,00	1.548,00	1.691,00
<b>CL 58 ... CL 67</b>	+ 10 mm adjustability on item code measure	<b>31</b>	1.151,00	1.264,00	1.319,00	1.451,00	1.596,00
		<b>21</b>	1.180,00	1.293,00	1.344,00	1.475,00	1.624,00
		<b>09 - 14 - 39 - 61</b>	1.310,00	1.423,00	1.481,00	1.613,00	1.763,00
<b>CL 68 ... CL 79</b>	+ 10 mm adjustability on item code measure	<b>31</b>	1.200,00	1.322,00	1.380,00	1.520,00	1.669,00
		<b>21</b>	1.227,00	1.349,00	1.411,00	1.547,00	1.703,00
		<b>09 - 14 - 39 - 61</b>	1.361,00	1.484,00	1.551,00	1.691,00	1.847,00

**OPTIONS - For customized solutions the additional costs have to be applied on made to measure prices**

<b>Glass</b>	<b>TPA</b>	133,00	treatment preventing limescale TPA Virgola included
	<b>Screen print</b>	144,00	decors: D50 D51 D52 D54 D55 D60 D61
	<b>Personal Glass</b>	222,00	decors: P13 P15 P16 P19 P32 P56 P70
<b>Profiles</b>	<b>Aluminium magnetic profile</b>	111,00	magnetic strip in aluminium profile
	<b>32</b>	+ 20%	on bright silver 21
	<b>05÷15 / 23 / 33 / 38 / 52 / 73 / 84</b>	+ 25%	on bright silver 21
	<b>34 / 35 / 54</b>	1.543,00	on bright silver 21
<b>Special sizes</b>	<b>Lower height</b>	+ 5%	less than cm 200
	<b>Higher height</b>	+ 15%	higher height - max. cm 215
	<b>Higher height</b>	+ 30%	higher height - max. cm 230

**Product description**

Shower enclosure with sliding opening, for shower trays in recess, composed by a central sliding door and two fixed in line panels.

**Characteristics**

Adjustability **60 mm**, obtained without the extension of the wall profile, which retains its aesthetic.

Optional compact wall profile **AS10** - supplied under separate order (ATTENTION: adjustability reduced to only 40 mm)

Door with releasable system.

Rollers with ball bearings.

Items in matt black **09**, moka **38** or metal gun **39** finishing are equipped with black seals.

Double possibility of adjustment, lateral and longitudinal.

**S.M.F.** (easy mounting system).

Prodotto conforme alla norma UNI-EN14428:2018:2015 e marchiato **CE**

**Materials**

Tempered glass 8 mm

Anodized or enamelled aluminium profiles.



**Technical specifications**

Please always advise the exact dimensions of the recess **X** and specify if **DX** right or **SX** left opening.

\* profiles' height 200 cm  
total height 201 cm

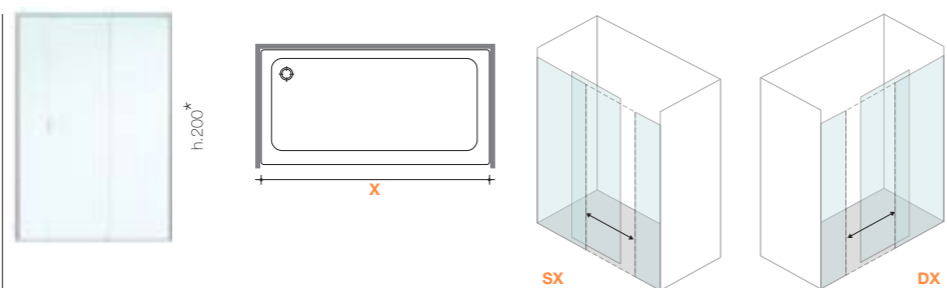

article	boxes	dimension of recess X	opening
<b>C3 138-199</b>	3	Serie 8000 shower enclosure "C3" is always custom made (cm by cm).  Ex: <b>C3 155</b> = shower enclosure for recess between cm 155 and 161.	Unless specific requests, the dimension of the door is approximately 40% of the recess.

**ATTENTION:** Serie 8000 shower enclosures are designed to be installed on a standard shower tray. In the case of installation on the floor or on special shower trays that may need a custom size, the installation layout sheet (see pages 338-339) must be complete and attached to the order.

serie 8000  
**C3**

glasses

<b>04</b> clear glass	<b>05</b> Timeless® anti-corrosion low maintenance glass. NO TPA available	<b>03</b> clear bronze	<b>01</b> obscure glass	<b>06</b> reflecting
		<b>07</b> clear grey	<b>08</b> satin glass	<b>10</b> extra-reflex
			<b>11</b> cathedral	<b>14</b> satin extra-light
			<b>12</b> extra-light	<b>29</b> madras nuvola

**MADE TO MEASURE**

codes	dimension of recess	profiles					
<b>C3 138 ... C3 157</b>	+ 60 mm adjustability on item code measure	<b>31</b>	2.170,00	2.372,00	2.456,00	2.677,00	2.947,00
		<b>21</b>	2.208,00	2.410,00	2.495,00	2.715,00	2.986,00
		<b>09 - 14 - 39 - 61</b>	2.451,00	2.653,00	2.747,00	2.969,00	3.242,00
<b>C3 158 ... C3 177</b>	+ 60 mm adjustability on item code measure	<b>31</b>	2.268,00	2.495,00	2.590,00	2.836,00	3.121,00
		<b>21</b>	2.307,00	2.534,00	2.628,00	2.876,00	3.164,00
		<b>09 - 14 - 39 - 61</b>	2.560,00	2.787,00	2.893,00	3.142,00	3.432,00
<b>C3 178 ... C3 199</b>	+ 60 mm adjustability on item code measure	<b>31</b>	2.363,00	2.620,00	2.721,00	2.998,00	3.301,00
		<b>21</b>	2.405,00	2.662,00	2.762,00	3.040,00	3.348,00
		<b>09 - 14 - 39 - 61</b>	2.672,00	2.928,00	3.040,00	3.320,00	3.629,00

**OPTIONS - For customized solutions the additional costs have to be applied on made to measure prices**

<b>Glass</b>	<b>TPA</b>	233,00	treatment preventing limescale TPA Virgola included
	<b>Screen print</b>	222,00	decors: D50 D51 D52 D54 D55 D60 D61
	<b>Personal Glass</b>	333,00	decors: P13 P15 P16 P19 P32 P56 P70
<b>Profiles</b>	<b>32</b>	+ 20%	on bright silver 21
	<b>05-15 / 23 / 33 / 38 / 52 / 73 / 84</b>	+ 25%	on bright silver 21
	<b>34 / 35 / 54</b>	2.015,00	on bright silver 21
<b>Special sizes</b>	<b>Lower height</b>	+ 5%	less than cm 200
	<b>Higher height</b>	+ 15%	more than cm 200 (max. cm 215)
	<b>Higher height</b>	+ 30%	more than cm 215 (max. cm 230)
	<b>Special width</b>	+ 10% on C3 138	less than cm 138 (min. cm 120)
	<b>Special configurations</b>	no extra charge	door/fix configuration in special dimensions

**Custom solutions** By connecting to the web page shown below, via QR code or by typing the address into your computer browser, you can get information on the custom solutions available for this model and the related additional costs. The examples are just indicative. Being customized solutions, it is necessary to submit an enquiry to our Technical Department so to check the feasibility and get an indication of the price.



[vism.it/LS/LSC3.pdf](http://vism.it/LS/LSC3.pdf)

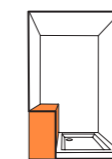

low wall in alignment to the door



shaped wall

**Product description**

Shower enclosure with sliding opening, for shower trays in recess, composed by two central doors and two fixes in line panels.

**Characteristics**

Adjustability **60 mm**, obtained without the extension of the wall profile, which retains its aesthetic.

Optional compact wall profile **AS10** - supplied under separate order (ATTENTION: adjustability reduced to only 40 mm)

Vertical PVC seals with magnetic strips. Items in matt black **09**, moka **38** or metal gun **39** finishing are equipped with black seals.

Rollers with ball bearings.

Door with releasable system.

Double possibility of adjustment, lateral and longitudinal.

**S.M.F.** (easy mounting system).

Product conforming to EN14428:2018 with **CE** marking.

**Materials**

Tempered glass 8 mm.

Anodized or enamelled aluminium profiles.



**Technical specifications**

Please always advise the exact dimensions of the recess **X**.

\* profiles' height 200 cm total height 201 cm

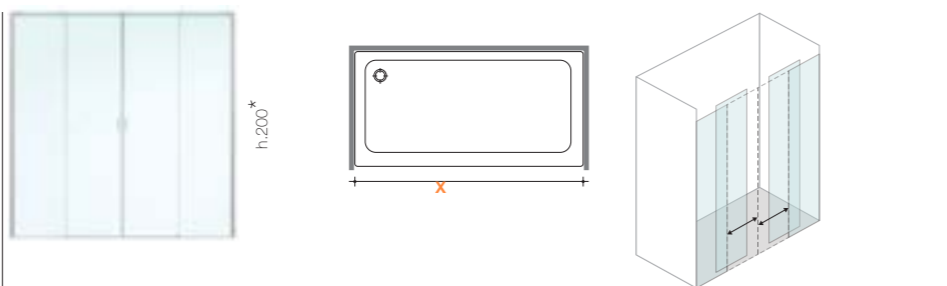

article	boxes	dimension of recess X	opening
<b>C4 158-219</b>	4	Serie 8000 shower enclosure "C4" is always custom made (cm by cm).  Ex: <b>C4 185</b> = shower enclosure for recess between cm 185 and 191.	The dimension of the two doors is approximately half of the recess.  Ex. recess: 180 cm opening: 78 cm

**ATTENTION:** Serie 8000 shower enclosures are designed to be installed on a standard shower tray. In the case of installation on the floor or on special shower trays that may need a custom size, the installation layout sheet (see pages 338-339) must be complete and attached to the order.

serie 8000  
**C4**

glasses

**04** clear glass

**05** Timeless®  
anti-corrosion low maintenance glass.  
NO TPA available

**03** clear bronze  
**07** clear grey

**01** obscure glass  
**08** satin glass

**06** reflecting  
**10** extra-reflex

**11** cathedral  
**12** extra-light

**14** satin extra-light  
**29** madras nuvola

**MADE TO MEASURE**

codes	dimension of recess	profiles					
<b>C4 158 ... C4 177</b>	+ 60 mm adjustability on item code measure	<b>31</b>	2.551,00	2.778,00	2.880,00	3.127,00	3.439,00
		<b>21</b>	2.587,00	2.815,00	2.920,00	3.168,00	3.485,00
		<b>09 - 14 - 39 - 61</b>	2.873,00	3.100,00	3.217,00	3.467,00	3.787,00
<b>C4 178 ... C4 197</b>	+ 60 mm adjustability on item code measure	<b>31</b>	2.653,00	2.907,00	3.017,00	3.294,00	3.624,00
		<b>21</b>	2.693,00	2.947,00	3.060,00	3.338,00	3.673,00
		<b>09 - 14 - 39 - 61</b>	2.993,00	3.247,00	3.370,00	3.652,00	3.990,00
<b>C4 198 ... C4 219</b>	+ 60 mm adjustability on item code measure	<b>31</b>	2.755,00	3.037,00	3.155,00	3.464,00	3.808,00
		<b>21</b>	2.803,00	3.085,00	3.200,00	3.511,00	3.861,00
		<b>09 - 14 - 39 - 61</b>	3.111,00	3.393,00	3.523,00	3.836,00	4.188,00

**OPTIONS**

<b>Glass</b>	<b>TPA</b>	261,00	treatment preventing limescale TPA Virgola included
	<b>Screen print</b>	239,00	decors: D50 D51 D52 D54 D55 D60 D61
	<b>Personal Glass</b>	361,00	decors: P13 P15 P16 P19 P32 P56 P70
<b>Profiles</b>	<b>Aluminium magnetic profile</b>	216,00	magnetic strip in aluminium profile
	<b>32</b>	+ 20%	on bright silver 21
	<b>05-15 / 23 / 33 / 38 / 52 / 73 / 84</b>	+ 25%	on bright silver 21
	<b>34 / 35 / 54</b>	2.320,00	on bright silver 21
<b>Special sizes</b>	<b>Lower height</b>	+ 5%	less than cm 200
	<b>Higher height</b>	+ 15%	higher height - max. cm 215
	<b>Higher height</b>	+ 30%	higher height - max. cm 230
	<b>Special width</b>	+ 10% on C4 158	less than cm 158 (min. cm 140)

**Custom solutions**

By connecting to the web page shown below, via QR code or by typing the address into your computer browser, you can get information on the custom solutions available for this model and the related additional costs. The examples are just indicative. Being customized solutions, it is necessary to submit an enquiry to our Technical Department so to check the feasibility and get an indication of the price.



[vism.it/LS/LSC4.pdf](http://vism.it/LS/LSC4.pdf)

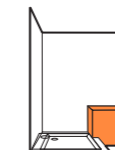

shaped wall



shower element compatible with the need of people with reduced mobility





**Product description**

Sliding door for corner shower trays.

**Characteristics**

A corner shower enclosure can be obtained with another element CA.

Adjustability **30** mm, obtained without the extension of the wall profile, which retains its aesthetic.

Optional compact wall profile **AS10** - supplied under separate order  
(ATTENTION: adjustability reduced to only 20 mm)

Vertical PVC seals with magnetic strips.  
Items in matt black **09**, moka **38** or metal gun **39** finishing are equipped with black seals.

Door with releasable system.

Double possibility of adjustment, lateral and longitudinal.

**S.M.F.**  
(easy mounting system).

Product conforming to EN14428:2018 with **CE** marking

**Materials**

Tempered glass 8 mm

Anodized or enamelled aluminium profiles.



**Technical specifications**

Please always advise the exact dimensions of the installed shower tray **X** and specify if **DX** right or **SX** left opening.

A corner shower enclosure can be obtained with two CA elements.

\* profiles' height 200 cm  
total height 201 cm

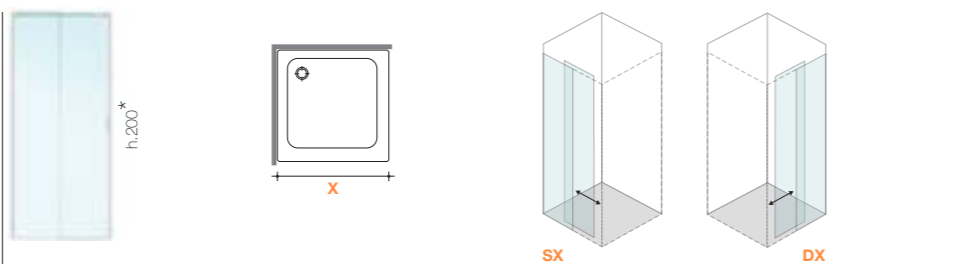

article	boxes	dimension of the installed shower tray X	corner opening cm
CA 68÷119	2	Serie 8000 "CA" is always custom made (cm by cm).  Es: CA 82 = shower enclosure for installed shower tray between cm 82 and cm 85.	The dimension of the door is approximately 1/2 of the element.  Ex: corner tray 90 x 90 cm; corner opening 54 cm

**ATTENTION:** Serie 8000 shower enclosures are designed to be installed on a standard shower tray. In the case of installation on the floor or on special shower trays that may need a custom size, the installation layout sheet (see pages 338-339) must be complete and attached to the order.

serie 8000  
CA

glasses

04 clear glass	04 + TPA Treatment preventing limescale TPA Virgola included					
----------------	---	--	--	--	--	--

**STANDARD DIMENSIONS**

codes	dimension of shower tray	profiles				
CA 68	68-71	21 bright silver	1.037,00	1.170,00	<b>ATTENTION</b> the model CA in standard dimension can be combined exclusively with another element CA.	
CA 78	78-81	21 bright silver	1.081,00	1.214,00		
CA 88	88-91	21 bright silver	1.129,00	1.262,00		
CA 98	98-101	21 bright silver	1.177,00	1.310,00		

Quick delivery items.

glasses

04 clear glass	05 Timeless® anti-corrosion low maintenance glass. NO TPA available	03 clear bronze	01 obscure glass	06 reflecting
		07 clear grey	08 satin glass	10 extra-reflex
			11 cathedral	14 satin extra-light
			12 extra-light	29 madras nuvola

**MADE TO MEASURE**

codes	dimension of shower tray	profiles					
CA 68 ... CA 77	+ 30 mm adjustability on item code measure	31	1.101,00	1.200,00	1.231,00	1.309,00	1.436,00
		21	1.128,00	1.227,00	1.263,00	1.333,00	1.470,00
		09 - 14 - 39 - 61	1.252,00	1.351,00	1.392,00	1.464,00	1.601,00
CA 78 ... CA 87	+ 30 mm adjustability on item code measure	31	1.151,00	1.263,00	1.301,00	1.400,00	1.536,00
		21	1.177,00	1.289,00	1.328,00	1.427,00	1.573,00
		09 - 14 - 39 - 61	1.306,00	1.419,00	1.463,00	1.563,00	1.711,00
CA 88 ... CA 97	+ 30 mm adjustability on item code measure	31	1.194,00	1.320,00	1.362,00	1.489,00	1.639,00
		21	1.227,00	1.352,00	1.392,00	1.518,00	1.669,00
		09 - 14 - 39 - 61	1.362,00	1.487,00	1.533,00	1.663,00	1.814,00
CA 98 ... CA 107	+ 30 mm adjustability on item code measure	31	1.315,00	1.453,00	1.495,00	1.636,00	1.803,00
		21	1.348,00	1.485,00	1.532,00	1.669,00	1.836,00
		09 - 14 - 39 - 61	1.494,00	1.632,00	1.685,00	1.825,00	1.994,00
CA 108 ... CA 119 (1)	+ 30 mm adjustability on item code measure	31	1.434,00	1.587,00	1.633,00	1.786,00	1.966,00
		21	1.472,00	1.625,00	1.671,00	1.823,00	2.002,00
		09 - 14 - 39 - 61	1.633,00	1.786,00	1.840,00	1.992,00	2.176,00

(1) Door's dimension max cm 49

**OPTIONS - For customized solutions the additional costs have to be applied on made to measure prices**

Category	Option	Cost	Description
<b>Glass</b>	TPA	144,00	treatment preventing limescale TPA Virgola included
	Screen print	155,00	decors: D50 D51 D52 D54 D55 D60 D61
	Personal Glass	244,00	decors: P13 P15 P16 P19 P32 P56 P70
<b>Profiles</b>	Aluminium magnetic profile	111,00	magnetic strip in aluminium profile
	32	+ 20%	on bright silver 21
	05÷15 / 23 / 33 / 38 / 52 / 73 / 84	+ 25%	on bright silver 21
	34 / 35 / 54	1.249,00	on bright silver 21
<b>Special sizes</b>	Lower height	+ 5%	less than cm 200
	Higher height	+ 15%	higher height - max. cm 215
	Higher height	+ 30%	higher height - max. cm 230
	Special width	no extra charge	less than cm 68 (min cm. 60)

**Custom solutions**

By connecting to the web page shown below, via QR code or by typing the address into your computer browser, you can get information on the custom solutions available for this model and the related additional costs. The examples are just indicative. Being customized solutions, it is necessary to submit an enquiry to our Technical Department so to check the feasibility and get an indication of the price.



[vism.it/LS/LSCA.pdf](http://vism.it/LS/LSCA.pdf)

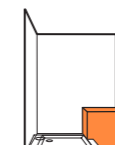

shaped wall only fixed side

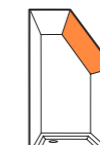

sloped or shape ceiling only fixed side

**Product description**

Additional fixed panel CG for corner or three sided shower enclosure.

**Characteristics**

Adjustability **20** mm, obtained without the extension of the wall profile, which retains its aesthetic.

Optional compact wall profile **AS10** - supplied under separate order (ATTENTION: adjustability reduced to only 10 mm).

Double possibility of adjustment, lateral and longitudinal.

It can be assembled to all elements of Serie 8000 programme.

**S.M.F.**  
(easy mounting system).

Product conforming to EN14428:2018 with **CE** marking

**Materials**

Tempered glass 8 mm

Anodized or enamelled aluminium profiles.



serie 8000  
**CG**

**MADE TO MEASURE**

codes	dimension of shower tray	profiles	glasses	04 clear glass	05 Timeless® anti-corrosion low maintenance glass. NO TPA available	03 clear bronze	01 obscure glass	06 reflecting
CG 68 ... CG 77	+ 20 mm adjustability on item code measure	31		850,00	949,00	988,00	1.127,00	1.241,00
		21		870,00	969,00	1.011,00	1.151,00	1.268,00
		09 - 14 - 39 - 61		966,00	1.064,00	1.111,00	1.253,00	1.369,00
CG 78 ... CG 87	+ 20 mm adjustability on item code measure	31		902,00	1.015,00	1.071,00	1.224,00	1.346,00
		21		925,00	1.037,00	1.093,00	1.244,00	1.370,00
		09 - 14 - 39 - 61		1.028,00	1.140,00	1.199,00	1.355,00	1.480,00
CG 88 ... CG 99	+ 20 mm adjustability on item code measure	31		956,00	1.081,00	1.153,00	1.319,00	1.451,00
		21		980,00	1.106,00	1.178,00	1.339,00	1.473,00
		09 - 14 - 39 - 61		1.087,00	1.212,00	1.288,00	1.455,00	1.590,00
CG 98 ... CG 107	+ 20 mm adjustability on item code measure	31		1.053,00	1.191,00	1.270,00	1.450,00	1.594,00
		21		1.077,00	1.214,00	1.291,00	1.474,00	1.622,00
		09 - 14 - 39 - 61		1.198,00	1.335,00	1.419,00	1.602,00	1.749,00
CG 108 ... CG 119 (1)	+ 20 mm adjustability on item code measure	31		1.194,00	1.348,00	1.443,00	1.648,00	1.814,00
		21		1.225,00	1.379,00	1.471,00	1.676,00	1.841,00
		09 - 14 - 39 - 61		1.361,00	1.514,00	1.612,00	1.819,00	1.987,00

(1) Attention: packed in wooden box, with no extra cost



**Technical specifications**

Please always advise the exact dimensions of the installed shower tray **X** and specify if **DX** right or **SX** left to the door

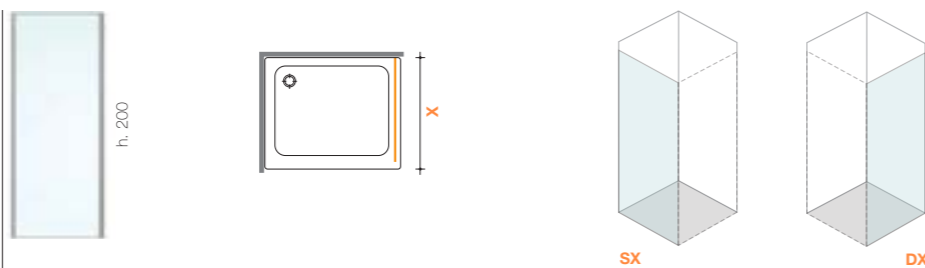

article	boxes	dimension of the installed shower tray <b>X</b>
CG 68-119	1	Serie 8000 shower element "CG" is always custom made (cm by cm). Ex: <b>CG 85</b> = shower enclosure for installed shower tray between cm 85 and cm 87.

**ATTENTION:** Serie 8000 shower enclosures are designed to be installed on a standard shower tray. In the case of installation on the floor or on special shower trays that may need a custom size, the installation layout sheet (see pages 338-339) must be complete and attached to the order.

**OPTIONS**

<b>Parete radiante heating panel</b>	see pages 318 ÷ 321 for information and prices
<b>External towelrack</b>	see page 326 for informations and prices
<b>Glass</b>	<b>TPA</b> 105,00 from DG 68 to DG 97 - treatment preventing limescale TPA
	<b>TPA</b> 150,00 from DG 98 to DG 139 - treatment preventing limescale TPA
	<b>Screen print</b> 144,00 decors: D50 D51 D52 D54 D55 D60 D61
	<b>Personal Glass</b> 144,00 decors: P13 P15 P16 P19 P32 P56 P70
<b>Profiles</b>	<b>32</b> + 20% on bright silver 21
	<b>05 ÷ 15 / 23 / 33 / 38 / 52 / 73 / 84</b> + 25% on bright silver 21
	<b>34 / 35 / 54</b> 1.077,00 on bright silver 21
<b>Special sizes</b>	<b>Lower height</b> + 5% less than cm 200
	<b>Higher height</b> + 15% higher height - max. cm 215
	<b>Higher height</b> + 30% higher height - max. cm 230 - till max CG 99
	<b>Special width</b> no extra charge less than cm 68

**Custom solutions** By connecting to the web page shown below, via QR code or by typing the address into your computer browser, you can get information on the custom solutions available for this model and the related additional costs. The examples are just indicative. Being customized solutions, it is necessary to submit an enquiry to our Technical Department so to check the feasibility and get an indication of the price.



[vism.it/LS/LSCG.pdf](http://vism.it/LS/LSCG.pdf)

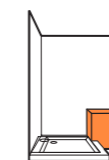

shaped wall

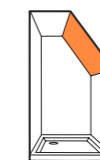

sloped or shape ceiling

**Product description**

Fixed panel CP for installations on a bath tub or on a low wall.

**Characteristics**

Adjustability **20** mm.

Adjustment of the panel for not vertical wall

It can be assembled to all elements of Serie 8000 programme.

Product conforming to EN14428:2018 with **CE** marking

**Materials**

Tempered glass 8 mm

Anodized or enamelled aluminium profiles.



**Technical specifications**

The CP panel is always custom made. Please advise the correct dimensions (width and height) and specify if left **SX** or right **DX** to the door.

Please always attach to the order sheet the technical drawing (from page 340 to page 343)

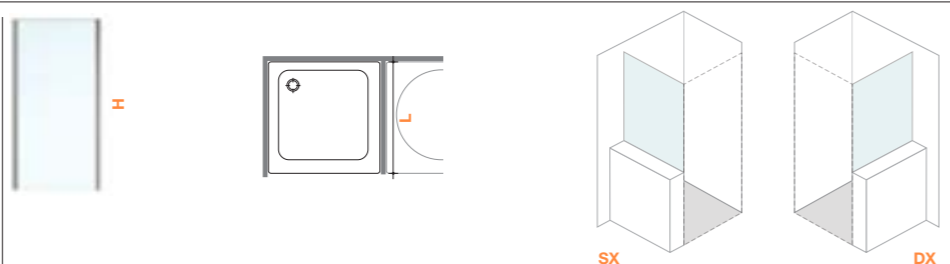

article	boxes	dimension L	dimension H
<b>CP 140</b>	1	from 60 to 100	from 100 to 170

serie 8000  
CP

glasses

**04** clear glass

**05** Timeless®  
anti-corrosion low  
maintenance glass.  
NO TPA available

**03** clear bronze  
**07** clear grey

**01** obscure glass  
**08** satin glass

**06** reflecting  
**10** extra-reflex

**11** cathedral  
**12** extra-light

**14** satin extra-light  
**29** madras nuvola

**MADE TO MEASURE**

codes	dimension of recess	profiles					
<b>CP 140</b>	+ 20 mm adjustability on item code measure	<b>31</b>	780,00	877,00	896,00	996,00	1.096,00
		<b>21</b>	821,00	918,00	940,00	1.037,00	1.138,00
		<b>09 - 14 - 39 - 61</b>	911,00	1.008,00	1.033,00	1.130,00	1.233,00

**OPTIONS**

<b>Glass</b>	<b>TPA</b>	89,00	treatment preventing limescale TPA
	<b>Screen print</b>	133,00	decors: D50 D51 D52 D54 D55 D60 D61
	<b>Personal Glass</b>	200,00	decors: P19 P32 P70
<b>Profiles</b>	<b>32</b>	+ 20%	on bright silver 21
	<b>05 ÷ 15 / 23 / 33 / 38 / 52 / 73 / 84</b>	+ 25%	on bright silver 21
	<b>34 / 35 / 54</b>	1.077,00	on bright silver 21
<b>Special sizes</b>			

**Custom solutions**

By connecting to the web page shown below, via QR code or by typing the address into your computer browser, you can get information on the custom solutions available for this model and the related additional costs. The examples are just indicative. Being customized solutions, it is necessary to submit an enquiry to our Technical Department so to check the feasibility and get an indication of the price.

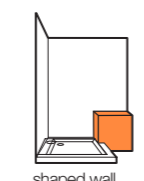

collections

# ESSENCE

smack

pag 244

junior

pag 264

serie 7200

pag 281

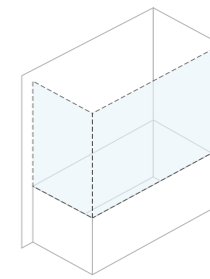
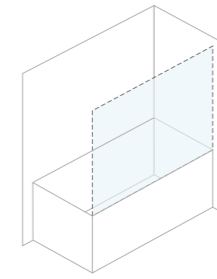
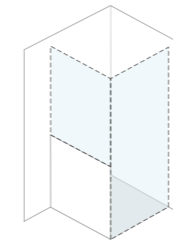
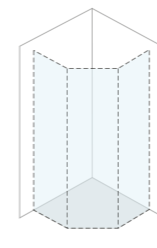
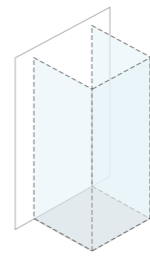
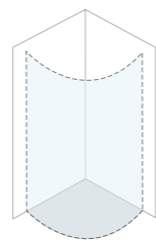
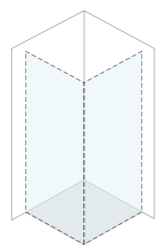
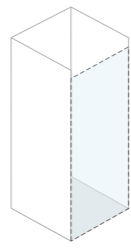

type	recess		corner		quadrant		3-sided		trial		side panel		bath screen 1 side		bath screen 2 sides	
	pag		pag		pag		pag		pag		pag		pag		pag	
smack	<b>MK</b>	248	<b>MK</b>	248							<b>MN+MP</b>	250/262				
	<b>MN</b>	250	<b>MA+MA</b>	256							<b>MB+MP</b>	252/262				
	<b>MB</b>	252	<b>MA+MF</b>	256/258							<b>M2+MP</b>	254/262				
	<b>M2</b>	254	<b>MB+MG</b>	252/260												
junior	<b>GN</b>	268	<b>GN+GF</b>	268/276			<b>GF+GN+GF</b>	276/268			<b>GN+GP</b>	268/278				
	<b>GM</b>	270	<b>GM+GF</b>	270/276			<b>GF+GA+GF</b>	276/272			<b>GM+GP</b>	270/278				
	<b>GA</b>	272	<b>GA+GF</b>	272/276							<b>GA+GP</b>	272/278				
	<b>G2</b>	274	<b>G2+GF</b>	274/276							<b>G2+GP</b>	274/278				
serie 7200	<b>ZN</b>	284	<b>ZQ+ZF</b>	286/288	<b>ZT</b>	294	<b>ZQ+ZF+ZG</b>	286/288/292			<b>ZN+ZP</b>	284/278				
			<b>ZA+ZA</b>	290	<b>ZD</b>	294	<b>ZA+ZA+ZG</b>	290/292								
			<b>ZN+ZG</b>	284/292												

# smack

collection



# smack

Simply light, simply functional!

**SMACK** goes to the very essence of its being, offering a basic version of the shower enclosure. Its inward or outward opening hinged door system adds versatility, making its everyday use and cleaning smooth and easy.

Available in several combinations: corner, recess, side panel or wall, single or double door, **SMACK** is a dream for any designer, who can adapt its minimal lines to any bathroom space.



The wall must be perpendicular to the door and the fixing base not less than 50 mm.

The installation system needs a free space of 10/12 cm above the shower enclosure to operate with a screw-driver.

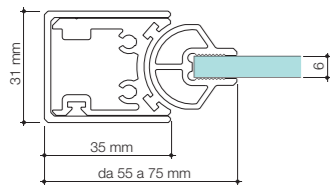

Wall profile on door elements

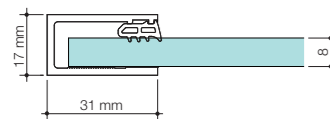

Wall profile on fixed elements

The complete range of Vismaravetro profiles is available upon request at the e-mail [info@vismaravetro.it](mailto:info@vismaravetro.it)

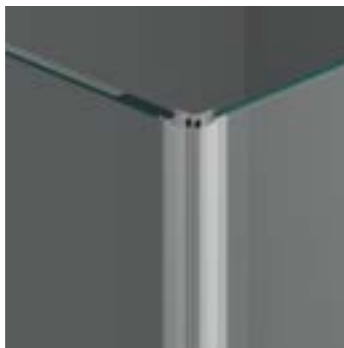

magnetic seals



SMF profiles



handle M7L



wall profile



smack  
type

recess



corner

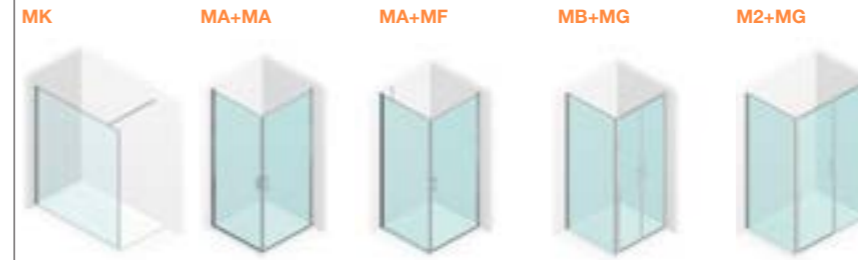

quadrant

3-sided

side panel



Descrizione prodotto

Fixed panel for recess or corner shower trays.

Characteristics

Adjustability 15 mm, obtained without the extension of the wall profile, which retains its aesthetic.

Reversible

Hardening rod 120 cm length

Reinforced cardboard packaging in two separate items.

Product conforming to EN14428:2018 with CE marking

Materials

Tempered glass 8 mm

Anodized or epoxy enamelled aluminium profiles.

Stability rod spec.

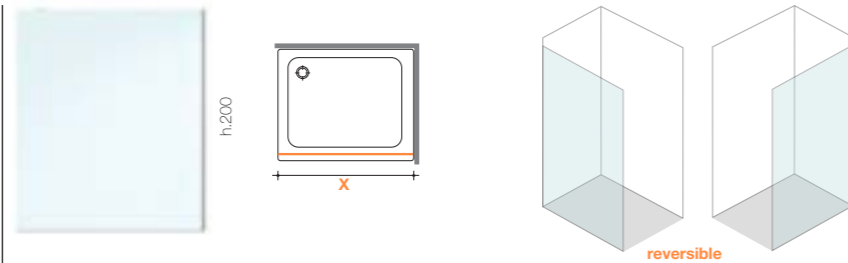

article	boxes	dimensions X
MK 78	2	78÷79,5 cm
MK 88	2	88÷89,5 cm
MK 98	2	98÷99,5 cm
MK 108	2	108÷109,5 cm
MK 118	2	118÷119,5 cm
MK 128	2	128÷129,5 cm
MK 138	2	138÷139,5 cm
MK 158	2	158÷159,5 cm

smack  
MK

STANDARD DIMENSIONS

codes	dimensions	profiles	glasses				
			04 clear glass	05 Timeless® anti-corrosion low maintenance glass	03 clear bronze	01 obscure glass	06 reflecting
MK 78	78÷79,5 cm	21 - 31	703,00	736,00	804,00	838,00	983,00
		09 - 15 - 39 - 61	772,00	838,00	873,00	908,00	1.053,00
		32 - 33 - 84	796,00	829,00	898,00	932,00	1.077,00
MK 88	88÷89,5 cm	21 - 31	749,00	824,00	864,00	902,00	1.066,00
		09 - 15 - 39 - 61	818,00	893,00	933,00	971,00	1.135,00
		32 - 33 - 84	843,00	917,00	957,00	996,00	1.159,00
MK 98	98÷99,5 cm	21 - 31	789,00	872,00	916,00	959,00	1.142,00
		09 - 15 - 39 - 61	858,00	942,00	986,00	1.029,00	1.211,00
		32 - 33 - 84	882,00	966,00	1.010,00	1.053,00	1.235,00
MK 108	108÷109,5 cm	21 - 31	825,00	914,00	966,00	1.013,00	1.214,00
		09 - 15 - 39 - 61	894,00	987,00	1.035,00	1.082,00	1.284,00
		32 - 33 - 84	919,00	1.008,00	1.059,00	1.107,00	1.308,00
MK 118	118÷119,5 cm	21 - 31	848,00	949,00	1.002,00	1.054,00	1.274,00
		09 - 15 - 39 - 61	917,00	1.019,00	1.071,00	1.123,00	1.343,00
		32 - 33 - 84	942,00	1.043,00	1.096,00	1.147,00	1.367,00
MK 128	128÷129,5 cm	21 - 31	901,00	1.011,00	1.068,00	1.124,00	1.364,00
		09 - 15 - 39 - 61	970,00	1.080,00	1.137,00	1.194,00	1.433,00
		32 - 33 - 84	994,00	1.104,00	1.162,00	1.218,00	1.458,00
MK 138	138÷139,5 cm	21 - 31	924,00	1.043,00	1.104,00	1.165,00	1.423,00
		09 - 15 - 39 - 61	993,00	1.112,00	1.174,00	1.234,00	1.493,00
		32 - 33 - 84	1.018,00	1.136,00	1.198,00	1.258,00	1.517,00
MK 158	158÷159,5 cm	21 - 31	987,00	1.123,00	1.194,00	1.263,00	1.559,00
		09 - 15 - 39 - 61	1.056,00	1.192,00	1.263,00	1.332,00	1.628,00
		32 - 33 - 84	1.080,00	1.217,00	1.287,00	1.356,00	1.652,00

Quick delivery items.

OPTIONS

Glass	TPA	95,00	from MK 78 to MK 88 - treatment preventing limescale TPA
	TPA	135,00	from MK 98 to MK 158 - treatment preventing limescale TPA
			TPA is available only on finitions: <b>01 - 03 - 06 - 07 - 08 - 11 - 14</b>
	Screen print	130,00	decor: D50

**Product description**

Frameless shower enclosure, pivot door (180°) for recess.

**Characteristics**

It can be extended up to 30 mm.

Double possibility of adjustment, lateral and longitudinal, upon completion of the installation, for an easy final adjustment before sealing.

Magnetic strips. Items in matt black **09** are equipped with black seals.

Inward and outward opening.

**S.M.F.** (easily mounting system).

Product conforming to EN 14428:2018 with **CE** marking.

**Materials**

Tempered safety glass 6 mm.

Anodised or enamelled aluminium profiles.

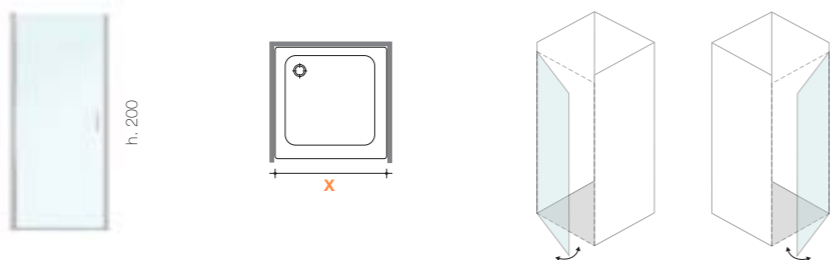

article	boxes	dimension of recess <b>X</b>	opening
<b>MN 67</b>	1	67÷70 cm	58 cm
<b>MN 77</b>	1	77÷80 cm	68 cm
<b>MN 87</b>	1	87÷90 cm	78 cm

**STANDARD DIMENSIONS**

codes	dimensions	profiles				
<b>MN 67</b>	67-70	<b>14</b> white	837,00	915,00	887,00	971,00
		<b>21</b> bright silver	855,00	933,00	905,00	989,00
		<b>09</b> matt black	886,00	964,00	936,00	1.019,00
<b>MN 77</b>	77-80	<b>14</b> white	868,00	958,00	926,00	1.022,00
		<b>21</b> bright silver	886,00	976,00	944,00	1.040,00
		<b>09</b> matt black	915,00	1.005,00	973,00	1.070,00
<b>MN 87</b>	87-90	<b>14</b> white	907,00	1.005,00	969,00	1.078,00
		<b>21</b> bright silver	921,00	1.019,00	983,00	1.092,00
		<b>09</b> matt black	951,00	1.049,00	1.013,00	1.122,00

**OPTIONS**

<b>Glass</b>	<b>07</b> clear grey	as <b>08</b> satin glass	minimum quantity: 10 pieces for each item
<b>Profiles</b>	finitions	no further finitions available	
<b>Special sizes</b>	<b>Special height</b>	NOT available	
	<b>Special width</b>	NOT available	

**Product description**

Frameless shower enclosure, two pivot doors (180°) for recess

**Characteristics**

Extensible **40** mm in recess.  
Extensible **30** mm in corner installations.

Double possibility of adjustment, lateral and longitudinal, upon completion of the installation, for an easy final adjustment before sealing.

Magnetic strips.  
Items in matt black **09** are equipped with black seals.

Inward and outward opening.

It can be assembled with a fix element MG to obtain a corner shower enclosure.

**S.M.F.**  
(easily mounting system).

Product conforming to EN 14428:2018 with **CE** marking.

**Materials**

Tempered safety glass 6 mm.  
Anodised or enamelled aluminium profiles.

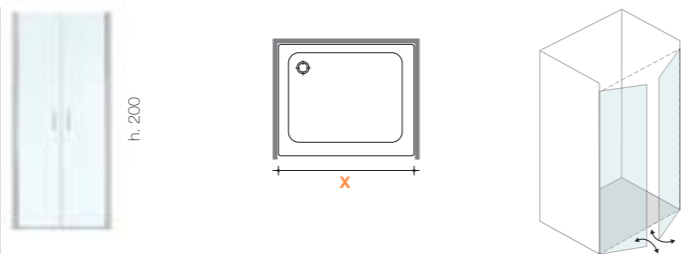

article	boxes	dimension of recess <b>x</b>	opening
<b>MB 86</b>	1	86÷90 cm	75 cm
<b>MB 96</b>	2	96÷100 cm	85 cm
<b>MB 116</b>	2	116÷120 cm	105 cm

**STANDARD DIMENSIONS**

codes	dimensions	profiles				
<b>MB 86</b>	86-90	<b>14</b> white	984,00	1.115,00	1.119,00	1.228,00
		<b>21</b> bright silver	998,00	1.129,00	1.133,00	1.243,00
		<b>09</b> matt black	1.032,00	1.164,00	1.169,00	1.279,00
<b>MB 96</b>	96-100	<b>14</b> white	1.016,00	1.165,00	1.164,00	1.293,00
		<b>21</b> bright silver	1.029,00	1.179,00	1.178,00	1.307,00
		<b>09</b> matt black	1.063,00	1.214,00	1.214,00	1.343,00
<b>MB 116</b>	116-120	<b>14</b> white	1.067,00	1.235,00	1.230,00	1.379,00
		<b>21</b> bright silver	1.081,00	1.249,00	1.245,00	1.393,00
		<b>09</b> matt black	1.114,00	1.284,00	1.281,00	1.429,00

**OPTIONS**

<b>Glass</b>	<b>07</b> clear grey	as <b>08</b> satin glass	minimum quantity: 10 pieces for each item
<b>Profiles</b>	finitions		no further finitions available
<b>Special sizes</b>	<b>Special height</b>		NOT available
	<b>Special width</b>		NOT available

**Product description**

Shower enclosure for recessed shower tray.  
One pivot door 180° and an in line fixed element.

**Characteristics**

Extensible **35** mm.  
Double possibility of adjustment, lateral and longitudinal, upon completion of the installation, for an easy final adjustment before sealing.

Magnetic strips.  
Items in matt black **09** are equipped with black seals.

Inward and outward opening.

It can be assembled with LG to obtain a corner shower enclosure.

**S.M.F.**  
(easily mounting system)

Product conforming to EN 14428:2018 with **CE** marking.

**Materials**

Tempered glass 6 mm for the door.  
Tempered glass 8 mm for the fix element.

Anodised or enamelled aluminium profiles.



**Technical specifications**

Please, always specify if left **SX** or right **DX** opening.

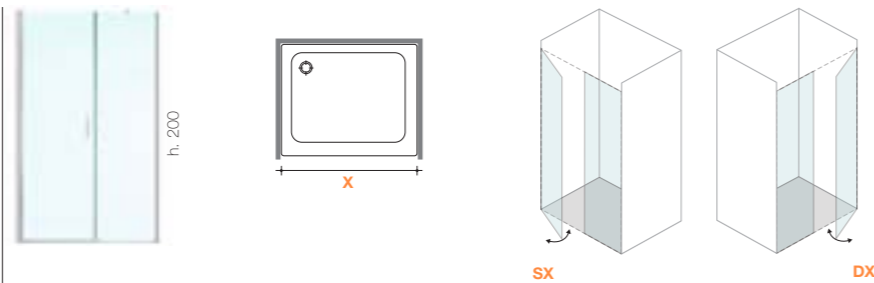

article	boxes	dimension X	opening
M2 97	1	97÷100,5 cm	59 cm
M2 107	2	107÷110,5 cm	66 cm
M2 117	2	117÷120,5 cm	72 cm
M2 137	2	137÷140,5 cm	86 cm

smack  
M2

glasses

**04** clear glass

**05** Timeless®  
anti-corrosion low maintenance glass

**08** satin glass

**08** satin glass + TPA

M2

**STANDARD DIMENSIONS**

codes	dimensions	profiles				
<b>M2 97</b>	97-100,5	<b>14</b> white	1.134,00	1.255,00	1.209,00	1.329,00
		<b>21</b> bright silver	1.145,00	1.266,00	1.220,00	1.340,00
		<b>09</b> matt black	1.172,00	1.293,00	1.247,00	1.367,00
<b>M2 107</b>	107-110,5	<b>14</b> white	1.157,00	1.291,00	1.240,00	1.374,00
		<b>21</b> bright silver	1.168,00	1.302,00	1.251,00	1.384,00
		<b>09</b> matt black	1.195,00	1.329,00	1.278,00	1.412,00
<b>M2 117</b>	117-120,5	<b>14</b> white	1.180,00	1.326,00	1.271,00	1.418,00
		<b>21</b> bright silver	1.191,00	1.337,00	1.282,00	1.429,00
		<b>09</b> matt black	1.218,00	1.364,00	1.309,00	1.456,00
<b>M2 137 (1)</b>	137-120,5	<b>14</b> white	1.348,00	1.531,00	1.461,00	1.641,00
		<b>21</b> bright silver	1.355,00	1.537,00	1.468,00	1.648,00
		<b>09</b> matt black	1.397,00	1.580,00	1.510,00	1.690,00

(1) Price includes 1 fixing bracket (fixing bracket "Q").

**OPTIONS**

<b>Glass</b>	<b>07</b> clear grey	as <b>08</b> satin glass	minimum quantity: 10 pieces for each item
<b>Profiles</b>	finitions		no further finitions available
<b>Special sizes</b>	<b>Special height</b>		NOT available
	<b>Special width</b>		NOT available

**Product description**

Frameless shower door; can be assembled with a fix element MF or with another MA to obtain a corner shower enclosure.

**Characteristics**

It can be extended up to **20** mm.

Double possibility of adjustment, lateral and longitudinal, upon completion of the installation, for an easy final adjustment before sealing.

Magnetic strips.  
Items in matt black **09** are equipped with black seals.

Only outward opening if assembled with MF.

**S.M.F.**  
(easily mounting system).

Product conforming to EN 14428:2018 with **CE** marking.

**Materials**

Tempered safety glass 6 mm.

Anodised or enamelled aluminium profiles.

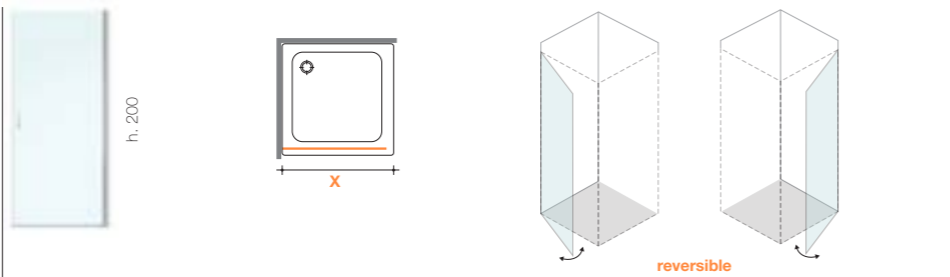

article	boxes	dimension X	opening
<b>MA 68</b>	1	68÷70 cm	61 cm
<b>MA 78</b>	1	78÷80 cm	71 cm
<b>MA 88</b>	1	88÷90 cm	81 cm

smack  
**MA**

glasses

**04** clear glass

**05** Timeless®  
anti-corrosion low  
maintenance glass

**08** satin glass

**08** satin glass + TPA

MA

**STANDARD DIMENSIONS**

codes	dimensions	profiles				
<b>MA 68</b>	68-70	<b>14</b> white	677,00	754,00	727,00	809,00
		<b>21</b> bright silver	685,00	762,00	734,00	817,00
		<b>09</b> matt black	703,00	780,00	753,00	835,00
<b>MA 78</b>	78-80	<b>14</b> white	708,00	798,00	766,00	861,00
		<b>21</b> bright silver	715,00	804,00	773,00	868,00
		<b>09</b> matt black	734,00	823,00	792,00	887,00
<b>MA 88</b>	88-90	<b>14</b> white	742,00	843,00	807,00	915,00
		<b>21</b> bright silver	750,00	851,00	815,00	923,00
		<b>09</b> matt black	768,00	869,00	833,00	941,00

**OPTIONS**

<b>Glass</b>	<b>07</b> clear grey	as <b>08</b> satin glass	minimum quantity: 10 pieces for each item
<b>Profiles</b>	finitions	no further finitions available	
<b>Special sizes</b>	<b>Special height</b>	NOT available	
	<b>Special width</b>	NOT available	

**Product description**

Fixed panel, can be combined with MA door to obtain a corner shower enclosure.

**Characteristics**

It can be extended up to **15** mm.

Double possibility of adjustment, lateral and longitudinal, upon completion of the installation, for an easy final adjustment before sealing

Magnetic strips. Items in matt black **09** are equipped with black seals.

**S.M.F.** (easily mounting system).

Product conforming to EN 14428:2018 with **CE** marking.

**Materials**

Tempered safety glass 8 mm.

Anodised or enamelled aluminium profiles.

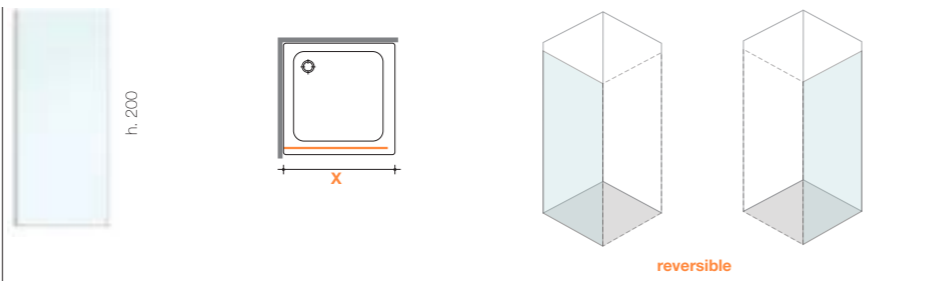

article	boxes	dimension X
<b>MF 68</b>	1	68÷69,5 cm
<b>MF 78</b>	1	78÷79,5 cm
<b>MF 88</b>	1	88÷89,5 cm
<b>MF 98</b>	1	98÷99,5 cm
<b>MF 118</b>	2	118÷119,5 cm

**STANDARD DIMENSIONS**

codes	dimensions	profiles				
<b>MF 68</b> (1)	68-69,5	<b>14</b> white	585,00	680,00	640,00	724,00
		<b>21</b> bright silver	588,00	683,00	644,00	728,00
		<b>09</b> matt black	599,00	694,00	654,00	738,00
<b>MF 78</b> (1)	78-79,5	<b>14</b> white	617,00	727,00	682,00	779,00
		<b>21</b> bright silver	620,00	730,00	685,00	782,00
		<b>09</b> matt black	631,00	741,00	696,00	792,00
<b>MF 88</b> (1)	88-89,5	<b>14</b> white	697,00	822,00	770,00	880,00
		<b>21</b> bright silver	700,00	825,00	774,00	883,00
		<b>09</b> matt black	711,00	835,00	784,00	894,00
<b>MF 98</b> (1)	98-99,5	<b>14</b> white	741,00	880,00	822,00	945,00
		<b>21</b> bright silver	744,00	883,00	826,00	948,00
		<b>09</b> matt black	755,00	894,00	836,00	959,00
<b>MF 118</b> (2) (3)	118-119,5	<b>14</b> white	913,00	1.082,00	1.012,00	1.160,00
		<b>21</b> bright silver	916,00	1.085,00	1.015,00	1.163,00
		<b>09</b> matt black	927,00	1.096,00	1.026,00	1.174,00

(1) Price includes 1 fixing bracket (fixing bracket "Q").  
 (2) Price includes 1 stabiliser rod (stabiliser rod "R 100").  
 (3) Packed in reinforced cardboard box with no extra costs.

**OPTIONS**

<b>Glass</b>	<b>07</b> clear grey	as <b>08</b> satin glass	minimum quantity: 10 pieces for each item
<b>Profiles</b>	finitions	no further finitions available	
<b>Special sizes</b>	<b>Special height</b>	NOT available	
	<b>Special width</b>	NOT available	

**Product description**

Fixed element for corner or 3 sided shower enclosure.

**Characteristics**

It can be assembled with MB - M2.

It can be extended up to **15** mm.

Double possibility of adjustment, lateral and longitudinal.

Hardening rod R120 included

**S.M.F.**

(easily mounting system).

Product conforming to EN 14428:2018 with **CE** marking

**Materials**

Tempered safety glass 8 mm.

Anodised or enamelled aluminium.



**Technical specifications**

Please, always specify if left **SX** or right **DX** opening.

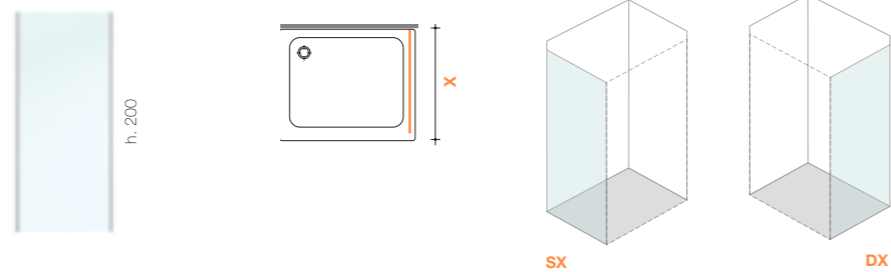
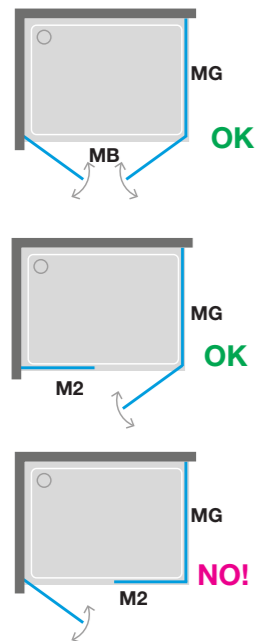

article	boxes	dimension X
<b>MG 68</b>	1	68÷69,5 cm
<b>MG 78</b>	1	78÷79,5 cm
<b>MG 88</b>	1	88÷89,5 cm

smack  
MG

glasses

**04** clear glass

**05** Timeless®  
anti-corrosion low  
maintenance glass

**08** satin glass

**08** satin glass + TPA

**STANDARD DIMENSIONS**

codes	dimensions	profiles				
<b>MG 68</b> (1)	68-69,5	<b>14</b> white	680,00	775,00	736,00	819,00
		<b>21</b> bright silver	683,00	778,00	739,00	823,00
		<b>09</b> matt black	700,00	795,00	756,00	840,00
<b>MG 78</b> (1)	78-79,5	<b>14</b> white	712,00	822,00	777,00	874,00
		<b>21</b> bright silver	716,00	825,00	780,00	877,00
		<b>09</b> matt black	733,00	842,00	797,00	894,00
<b>MG 88</b> (1)	88-89,5	<b>14</b> white	792,00	917,00	866,00	975,00
		<b>21</b> bright silver	796,00	920,00	869,00	978,00
		<b>09</b> matt black	813,00	937,00	886,00	996,00

(1) Price includes 1 stabiliser rod (stabiliser rod "R").

**OPTIONS**

<b>Glass</b>	<b>07</b> clear grey	as <b>08</b> satin glass	minimum quantity: 10 pieces for each item
<b>Profiles</b>	finitions	no further finitions available	
<b>Special sizes</b>	<b>Special height</b>	NOT available	
	<b>Special width</b>	NOT available	

**Product description**

Fixed panel MP for installations on a bath tub or on a low wall.

**Characteristics**

- Extensible **15** mm.
- To be assembled with elemen MN - MB - M2
- Horizontal and vertical of adjustment.
- Hardening rod R120 included
- Product conforming to EN 14428:2018 with **CE** marking.

**Materials**

- Tempered glass 8 mm.
- Anodised or enamelled aluminium profiles.



**Technical specifications**

The MP panel is always custom made. Please advise the correct dimensions (width and height) and specify if left **SX** or right **DX** to the door.

Please always attach to the order sheet the technical drawing (from page 340 to page 343)

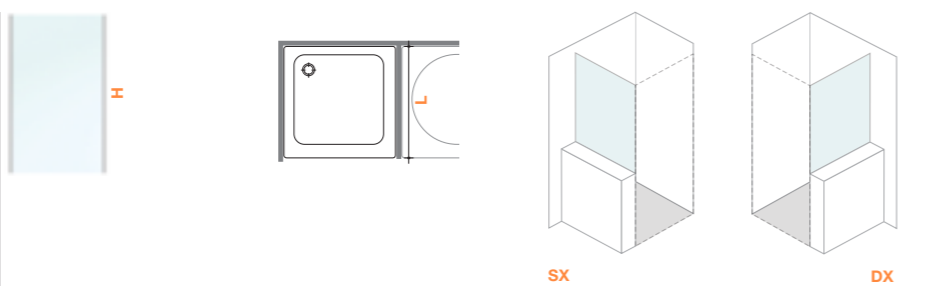

article	boxes	dimensions <b>L</b>	dimensions <b>H</b>
<b>MP 140</b>	1	from 60 to 100	from 100 to 170

smack  
**MP**

glasses

**04** clear glass

**05** Timeless®  
anti-corrosion low  
maintenance glass

**08** satin glass

**08** satin glass + TPA

**MP**

**MADE TO MEASURE**

codes	dimensions	profiles				
<b>MP 140</b>	+ 15 mm adjustability on item code measure	<b>14</b> white	746,00	842,00	968,00	1.057,00
		<b>21</b> bright silver	754,00	850,00	976,00	1.064,00
		<b>09</b> matt black	821,00	918,00	1.043,00	1.132,00

**OPTIONS**

<b>Glass</b>	<b>07</b> clear grey	as <b>08</b> satin glass
<b>Profiles</b>	finitions	no further finitions available
<b>Special sizes</b>		

low wall in alignment to the door      shaped wall      sloped or shape ceiling

# junior

collection



# junior

**Junior Collection** is the evolution of the shower enclosure through a new focus on the essential components: a hinged door, a folding door and a fixed side. A rigorous linear form, the extreme functionality of each detail, simple installation and exceptional performance are the main reference values of the Junior Collection: essentially as a project.

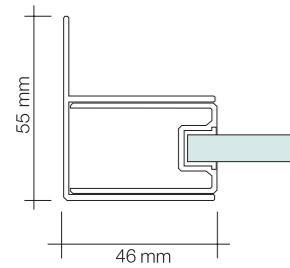

The complete range of **Vismaravetro profiles** is available upon request at the e-mail [info@vismaravetro.it](mailto:info@vismaravetro.it)

The glass panels of Junior Collection are inserted in the profiles using special self-locking seals. This solution guarantees the utmost stability of the ensemble and optimal waterproofing, all without the use of silicon for bonding and sealing components.

Hinges applied on the doors with flush screws. The inner face of the door is therefore free of obstructions to facilitate cleaning of the glass



folding hinge GN



pivoting hinge (inside)



pivoting hinge (outside)



sliding pin (engaged)



sliding pin (disengaged)

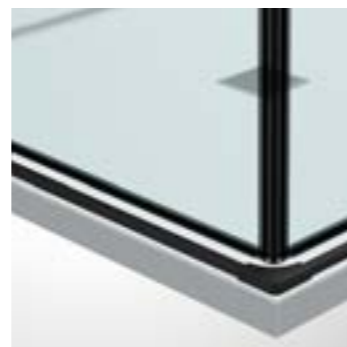

Items in matt black 09, moka 38 or metal gun 39 finishing are equipped with black seals.

junior  
type

recess



corner



quadrant

3-sided

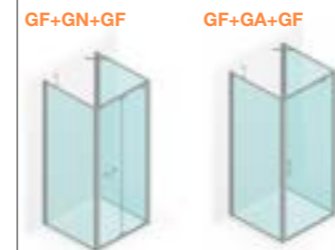

side panel



**Product description**

Framed shower enclosure with folding door.

**Characteristics**

It can be assembled with element GF to obtain a corner or three sided shower enclosure.

Extensible **60** mm in recess.  
Extensible **45** mm in corner installations.  
Extensible **30** mm in 3-sided installations.

Reversible.

Double possibility of adjustment, lateral and longitudinal, upon completion of the installation, for an easy final adjustment before sealing

Hinges applied on the doors with flush screws. The inner face of the door is therefore free of obstructions to facilitate cleaning of the glass

The door can be quickly uncoupled and opened outwards for cleaning and safety

This model is produced without silicon and is delivered completely assembled.

PVC seals with magnetic strips. Items in matt black **09**, moka **38** or metal gun **39** finishing are equipped with black seals.

Product conforming to EN 14428:2018 with **CE** marking

**Materials**

Tempered safety glass 6 mm.

Anodised or enamelled aluminium profiles.



**Technical specifications**

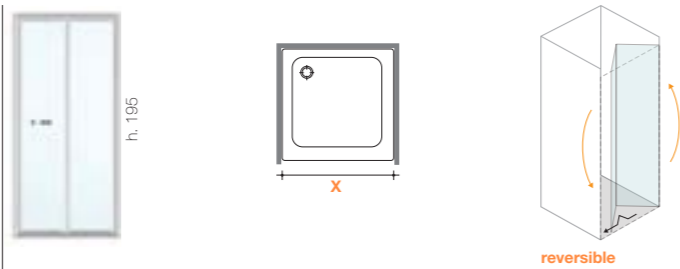

article	boxes	recess dimension X	corner dimension	opening
<b>GN 67</b>	1	67÷73	68÷72,5	50
<b>GN 72</b>	1	72÷78	73÷77,5	55
<b>GN 77</b>	1	77÷83	78÷82,5	60
<b>GN 82</b>	1	82÷88	83÷87,5	65
<b>GN 87</b>	1	87÷93	88÷92,5	70
<b>GN 92</b>	1	92÷98	93÷97,5	75

<b>04</b> clear glass	<b>05</b> Timeless® anti-corrosion low maintenance glass	<b>03</b> clear bronze	<b>01</b> obscure glass	<b>06</b> reflecting
		<b>07</b> clear grey	<b>08</b> satin glass	<b>10</b> extra-reflex
			<b>11</b> cathedral	<b>14</b> satin extra-light
			<b>12</b> extra-light	<b>29</b> madras nuvola

**STANDARD DIMENSIONS**

codes	dimension of shower tray	profiles					
<b>GN 67</b>	recess 67 ÷ 73 cm corner 68 ÷ 72,5 cm	<b>31</b>	1.049,00	1.139,00	1.152,00	1.224,00	1.346,00
		<b>21</b>	1.122,00	1.212,00	1.227,00	1.292,00	1.424,00
		<b>09 - 14 - 39</b>	1.233,00	1.323,00	1.363,00	1.435,00	1.567,00
<b>GN 72</b>	recess 72 ÷ 78 cm corner 73 ÷ 77,5 cm	<b>31</b>	1.066,00	1.162,00	1.179,00	1.257,00	1.381,00
		<b>21</b>	1.139,00	1.235,00	1.252,00	1.330,00	1.465,00
		<b>09 - 14 - 39</b>	1.253,00	1.350,00	1.392,00	1.472,00	1.611,00
<b>GN 77</b>	recess 77 ÷ 83 cm corner 78 ÷ 82,5 cm	<b>31</b>	1.083,00	1.187,00	1.199,00	1.290,00	1.421,00
		<b>21</b>	1.154,00	1.258,00	1.273,00	1.365,00	1.501,00
		<b>09 - 14 - 39</b>	1.272,00	1.375,00	1.419,00	1.511,00	1.649,00
<b>GN 82</b>	recess 82 ÷ 88 cm corner 83 ÷ 87,5 cm	<b>31</b>	1.102,00	1.212,00	1.225,00	1.325,00	1.459,00
		<b>21</b>	1.172,00	1.282,00	1.298,00	1.400,00	1.540,00
		<b>09 - 14 - 39</b>	1.290,00	1.400,00	1.444,00	1.547,00	1.691,00
<b>GN 87</b>	recess 87 ÷ 93 cm corner 88 ÷ 92,5 cm	<b>31</b>	1.122,00	1.238,00	1.248,00	1.363,00	1.497,00
		<b>21</b>	1.191,00	1.306,00	1.322,00	1.434,00	1.578,00
		<b>09 - 14 - 39</b>	1.310,00	1.425,00	1.470,00	1.584,00	1.732,00
<b>GN 92</b>	recess 92 ÷ 98 cm corner 93 ÷ 97,5 cm	<b>31</b>	1.148,00	1.270,00	1.279,00	1.404,00	1.543,00
		<b>21</b>	1.217,00	1.339,00	1.354,00	1.476,00	1.625,00
		<b>09 - 14 - 39</b>	1.339,00	1.461,00	1.506,00	1.633,00	1.782,00

Quick delivery items

**OPTIONS**

<b>Glass</b>	<b>TPA</b>	144,00	treatment preventing limescale TPA Virgola included
	<b>Screen print</b>	155,00	decors: D50 D51 D52 D54 D55 D60 D61
	<b>Personal Glass</b>	244,00	decors: P13 P15 P16 P19 P32 P56 P70
			ATTENTION for customized glasses, please always specify if left SX or right DX
<b>Profiles</b>	<b>32</b>	+ 20%	on bright silver 21
	<b>15 / 23 / 38 / 84</b>	+ 25%	on bright silver 21
<b>Special sizes</b>	<b>Lower height</b>	+ 5%	less than cm 195
	<b>Higher height</b>	+ 15%	more than cm 195 (max. cm 205)
	<b>Special width</b>	+ 10% on GN 67	less than cm 67 (min 62 cm)
	<b>Special width</b>	+ 10% on GN 92	larger than cm 92 (max. cm 95)
	<b>Special intermediate sizes</b>	+ 10%	on preceding standard measure

**Product description**

Framed shower enclosure with pivoting door.

**Characteristics**

It can be assembled with element GF to obtain a corner or three sided shower enclosure.

Extensible **60** mm in recess.  
Extensible **45** mm in corner installations.  
Extensible **30** mm in 3-sided installations.

Reversible.

Double possibility of adjustment, lateral and longitudinal, upon completion of the installation, for an easy final adjustment before sealing

Hinges applied on the doors with flush screws. The inner face of the door is therefore free of obstructions to facilitate cleaning of the glass

This model is produced without silicon and is delivered completely assembled.

PVC seals with magnetic strips.  
Items in matt black **09**, moka **38** or metal gun **39** finishing are equipped with black seals.

Product conforming to EN 14428:2018 with **CE** marking

**Materials**

Tempered safety glass 6 mm.  
Anodised or enamelled aluminium profiles.



**Technical specifications**

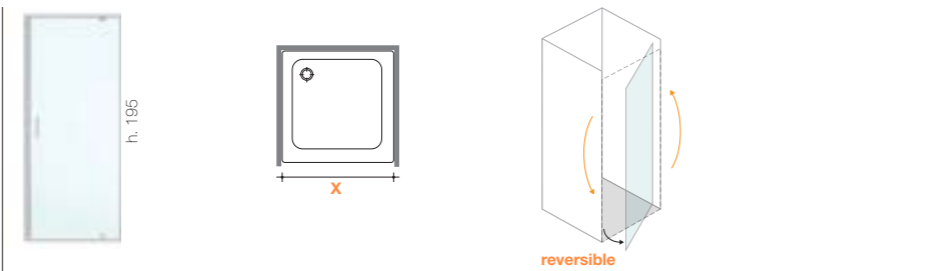

article	boxes	recess dimension X	corner dimension	opening cm	opening space cm
<b>GA 67</b>	1	67÷73	68÷72,5	52	52
<b>GA 72</b>	1	72÷78	73÷77,5	57	57
<b>GA 77</b>	1	77÷83	78÷82,5	57,5	57,5
<b>GA 82</b>	1	82÷88	83÷87,5	62,5	62,5
<b>GA 87</b>	1	87÷93	88÷92,5	63	63
<b>GA 92</b>	1	92÷98	93÷97,5	68	68

<b>04</b> clear glass	<b>05</b> Timeless® anti-corrosion low maintenance glass	<b>03</b> clear bronze	<b>01</b> obscure glass	<b>06</b> reflecting
		<b>07</b> clear grey	<b>08</b> satin glass	<b>10</b> extra-reflex
			<b>11</b> cathedral	<b>14</b> satin extra-light
			<b>12</b> extra-light	<b>29</b> madras nuvola

**STANDARD DIMENSIONS**

codes	dimension of shower tray	profiles					
<b>GA 67</b>	recess 67 ÷ 73 cm corner 68 ÷ 72,5 cm	<b>31</b>	872,00	962,00	972,00	1.040,00	1.146,00
		<b>21</b>	942,00	1.032,00	1.043,00	1.112,00	1.227,00
		<b>09 - 14 - 39</b>	1.037,00	1.127,00	1.159,00	1.231,00	1.346,00
<b>GA 72</b>	recess 72 ÷ 78 cm corner 73 ÷ 77,5 cm	<b>31</b>	890,00	987,00	997,00	1.076,00	1.183,00
		<b>21</b>	961,00	1.058,00	1.071,00	1.149,00	1.263,00
		<b>09 - 14 - 39</b>	1.060,00	1.157,00	1.189,00	1.270,00	1.389,00
<b>GA 77</b>	recess 77 ÷ 83 cm corner 78 ÷ 82,5 cm	<b>31</b>	906,00	1.009,00	1.018,00	1.108,00	1.222,00
		<b>21</b>	979,00	1.082,00	1.091,00	1.183,00	1.304,00
		<b>09 - 14 - 39</b>	1.077,00	1.180,00	1.214,00	1.308,00	1.430,00
<b>GA 82</b>	recess 82 ÷ 88 cm corner 83 ÷ 87,5 cm	<b>31</b>	922,00	1.032,00	1.042,00	1.147,00	1.259,00
		<b>21</b>	997,00	1.107,00	1.116,00	1.217,00	1.336,00
		<b>09 - 14 - 39</b>	1.096,00	1.205,00	1.239,00	1.343,00	1.466,00
<b>GA 87</b>	recess 87 ÷ 93 cm corner 88 ÷ 92,5 cm	<b>31</b>	942,00	1.058,00	1.067,00	1.180,00	1.300,00
		<b>21</b>	1.012,00	1.128,00	1.139,00	1.253,00	1.375,00
		<b>09 - 14 - 39</b>	1.112,00	1.228,00	1.265,00	1.380,00	1.506,00
<b>GA 92</b>	recess 92 ÷ 98 cm corner 93 ÷ 97,5 cm	<b>31</b>	968,00	1.090,00	1.098,00	1.224,00	1.346,00
		<b>21</b>	1.042,00	1.164,00	1.173,00	1.292,00	1.424,00
		<b>09 - 14 - 39</b>	1.148,00	1.270,00	1.302,00	1.425,00	1.558,00

Quick delivery items

**OPTIONS**

<b>Glass</b>	<b>TPA</b>	133,00	treatment preventing limescale TPA Virgola included
	<b>Screen print</b>	144,00	decors: D50 D51 D52 D54 D55 D60 D61
	<b>Personal Glass</b>	222,00	decors: P13 P15 P16 P19 P56 P70
		ATTENTION	for customized glasses, please always specify if left SX or right DX
<b>Profiles</b>	<b>32</b>	+ 20%	on bright silver 21
	<b>15 / 23 / 38 / 84</b>	+ 25%	on bright silver 21
<b>Special sizes</b>	<b>Lower height</b>	+ 5%	less than cm 195
	<b>Higher height</b>	+ 15%	more than cm 195 (max. cm 205)
	<b>Special width</b>	+ 10% on GA 67	less than cm 67 (min 62 cm)
	<b>Special width</b>	+ 10% on GA 92	larger than cm 92 (max. cm 95)
	<b>Special intermediate sizes</b>	+ 10%	on preceding standard measure

**Product description**

Fixed element for corner or three sided shower enclosures.

**Characteristics**

It can be assembled with element GN, GA, G2 and GM

Double possibility of adjustment, lateral and longitudinal, upon completion of the installation, for an easy final adjustment before sealing

Extensible **30** mm.

Reversible.

This model is assembled without silicon.

Items in matt black **09**, moka **38** or metal gun **39** finishing are equipped with black seals.

Product conforming to EN 14428:2018 with **CE** marking

**Materials**

Tempered safety glass 6 mm.

Anodised or enamelled aluminium profiles.



**Technical specifications**

If used for a 3-sided shower enclosure, two fixing brackets must be used (see page 330 - fixing bracket "G"). To be requested under separate order

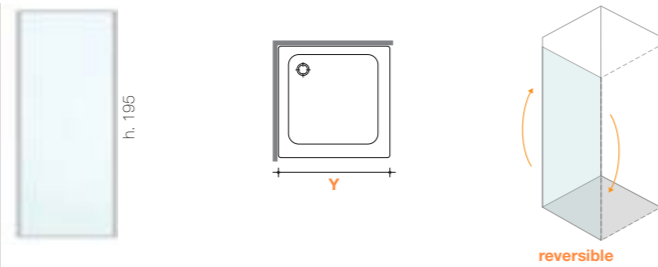

article	boxes	shower enclosure dimension Y
GF 67	1	67÷70
GF 72	1	72÷75
GF 77	1	77÷80
GF 82	1	82÷85
GF 87	1	87÷90
GF 92	1	92÷95
GF 97	1	97÷100
GF 107	1	107÷110
GF 117	1	127÷120

<b>04</b> clear glass	<b>05</b> Timeless® anti-corrosion low maintenance glass	<b>03</b> clear bronze <b>07</b> clear grey	<b>01</b> obscure glass <b>08</b> satin glass <b>11</b> cathedral <b>12</b> extra-light	<b>06</b> reflecting <b>10</b> extra-reflex <b>14</b> satin extra-light <b>29</b> madras nuvola
-----------------------	--	--	--	--

**STANDARD DIMENSIONS**

codes	dimension of shower tray	profiles					
<b>GF 67</b>	67 - 70 cm	<b>31</b>	549,00	639,00	646,00	713,00	785,00
		<b>21</b>	603,00	693,00	698,00	767,00	846,00
		<b>09 - 14 - 39</b>	664,00	754,00	774,00	846,00	924,00
<b>GF 72</b>	72 - 75 cm	<b>31</b>	571,00	667,00	666,00	748,00	824,00
		<b>21</b>	624,00	720,00	724,00	804,00	884,00
		<b>09 - 14 - 39</b>	686,00	783,00	801,00	882,00	963,00
<b>GF 77</b>	77 - 80 cm	<b>31</b>	587,00	690,00	693,00	784,00	861,00
		<b>21</b>	639,00	743,00	747,00	836,00	921,00
		<b>09 - 14 - 39</b>	702,00	805,00	827,00	916,00	1.002,00
<b>GF 82</b>	82 - 85 cm	<b>31</b>	603,00	713,00	714,00	818,00	899,00
		<b>21</b>	657,00	767,00	768,00	872,00	960,00
		<b>09 - 14 - 39</b>	725,00	835,00	851,00	957,00	1.047,00
<b>GF 87</b>	87 - 90 cm	<b>31</b>	624,00	739,00	739,00	850,00	936,00
		<b>21</b>	677,00	793,00	790,00	908,00	997,00
		<b>09 - 14 - 39</b>	745,00	860,00	877,00	992,00	1.084,00
<b>GF 92</b>	92 - 95 cm	<b>31</b>	647,00	769,00	771,00	896,00	987,00
		<b>21</b>	703,00	825,00	828,00	947,00	1.043,00
		<b>09 - 14 - 39</b>	775,00	897,00	915,00	1.039,00	1.137,00
<b>GF 97</b>	97 - 100 cm	<b>31</b>	677,00	806,00	805,00	939,00	1.031,00
		<b>21</b>	729,00	858,00	855,00	996,00	1.093,00
		<b>09 - 14 - 39</b>	804,00	932,00	947,00	1.087,00	1.188,00
<b>GF 107 (1)</b>	107 - 110 cm	<b>31</b>	896,00	1.038,00	1.018,00	1.199,00	1.321,00
		<b>21</b>	947,00	1.089,00	1.073,00	1.254,00	1.378,00
		<b>09 - 14 - 39</b>	1.020,00	1.162,00	1.168,00	1.350,00	1.476,00
<b>GF 117 (1)</b>	117 - 120 cm	<b>31</b>	987,00	1.141,00	1.122,00	1.385,00	1.527,00
		<b>21</b>	1.040,00	1.194,00	1.178,00	1.441,00	1.586,00
		<b>09 - 14 - 39</b>	1.112,00	1.267,00	1.274,00	1.541,00	1.691,00

**(1) Attention:**  
It can only be used in corner shower configurations.  
It cannot be used in niche configurations.

Quick delivery items

**OPTIONS**

Options	Price	Description
<b>Glass</b>	<b>TPA</b>	105,00 from GF 67 to GF 97 - treatment preventing limescale TPA
	<b>TPA</b>	150,00 from GF 107 to GF 117 - treatment preventing limescale TPA
	<b>Screen print</b>	144,00 decors: D50 D51 D52 D54 D55 D60 D61
	<b>Personal Glass</b>	222,00 decors: P13 P15 P16 P19 P56 P70
	ATTENTION	for customized glasses, please always specify if left SX or right DX
<b>Profiles</b>	<b>32</b>	+ 20% on bright silver 21
	<b>15 / 23 / 38 / 84</b>	+ 25% on bright silver 21
<b>Special sizes</b>	<b>Lower height</b>	+ 5% less than cm 195
	<b>Higher height</b>	+ 15% more than cm 195 - max. cm 205
	<b>Special width</b>	+ 10% on GF 67 less than cm 67 (min 30 cm)
	<b>Special intermediate sizes</b>	+ 10% on preceding standard measure

**Product description**

Framed shower enclosure with pivoting door and an in line fixed element.

**Characteristics**

It can be assembled with element GF to obtain a corner shower enclosure.

Extensible 60 mm in recess.  
Extensible 45 mm in corner installations.

Double possibility of adjustment, lateral and longitudinal, upon completion of the installation, for an easy final adjustment before sealing

Reversible.

Hinges applied on the doors with flush screws. The inner face of the door is therefore free of obstructions to facilitate cleaning of the glass

This model is produced without silicon

PVC seals with magnetic strips.  
Items in matt black **09**, moka **38** or metal gun **39** finishing are equipped with black seals.

Product conforming to EN 14428:2018 with **CE** marking

**Materials**

Tempered safety glass 6 mm.

Anodised or enamelled aluminium profiles



**Technical specifications**

Price includes one fixing bracket (see page 330 - fixing bracket "G").

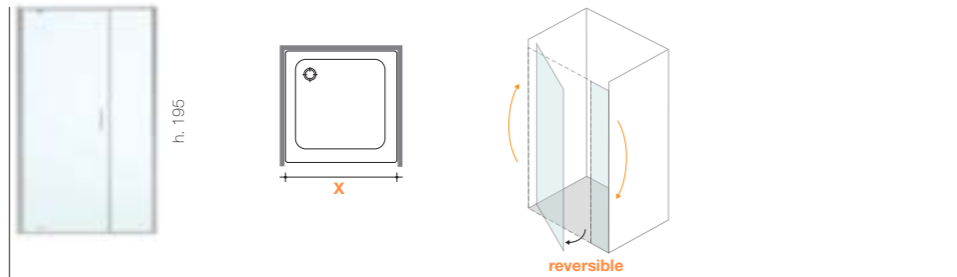

article	boxes	recess dimension X	corner dimension	door dimension cm	opening space cm
<b>G2 97</b>	2	97÷103	98÷102,5	60	52
<b>G2 107</b>	2	107÷113	108÷112,5	60	52
<b>G2 117</b>	2	117÷123	118÷122,5	70	57,5
<b>G2 137</b>	2	137÷143	138÷142,5	80	63

<b>04</b> clear glass	<b>05</b> Timeless® anti-corrosion low maintenance glass	<b>03</b> clear bronze	<b>01</b> obscure glass	<b>06</b> reflecting
		<b>07</b> clear grey	<b>08</b> satin glass	<b>10</b> extra-reflex
			<b>11</b> cathedral	<b>14</b> satin extra-light
			<b>12</b> extra-light	<b>29</b> madras nuvola

**STANDARD DIMENSIONS**

codes	dimension of shower tray	profiles	prices				
<b>G2 97</b>	recess 97 ÷ 103 cm corner 98 ÷ 102,5 cm	<b>31</b>	1.252,00	1.381,00	1.364,00	1.430,00	1.577,00
		<b>21</b>	1.319,00	1.447,00	1.430,00	1.500,00	1.651,00
		<b>09 - 14 - 39</b>	1.452,00	1.581,00	1.594,00	1.665,00	1.818,00
<b>G2 107</b>	recess 107 ÷ 113 cm corner 108 ÷ 112,5 cm	<b>31</b>	1.293,00	1.435,00	1.417,00	1.506,00	1.656,00
		<b>21</b>	1.363,00	1.505,00	1.487,00	1.578,00	1.735,00
		<b>09 - 14 - 39</b>	1.500,00	1.642,00	1.654,00	1.748,00	1.909,00
<b>G2 117</b>	recess 117 ÷ 123 cm corner 118 ÷ 122,5 cm	<b>31</b>	1.336,00	1.491,00	1.472,00	1.586,00	1.743,00
		<b>21</b>	1.404,00	1.558,00	1.540,00	1.652,00	1.818,00
		<b>09 - 14 - 39</b>	1.544,00	1.698,00	1.713,00	1.829,00	1.997,00
<b>G2 137</b>	recess 137 ÷ 143 cm corner 138 ÷ 142,5 cm	<b>31</b>	1.380,00	1.560,00	1.526,00	1.649,00	1.815,00
		<b>21</b>	1.447,00	1.627,00	1.592,00	1.718,00	1.894,00
		<b>09 - 14 - 39</b>	1.592,00	1.772,00	1.773,00	1.901,00	2.080,00

**OPTIONS**

<b>Glass</b>	<b>TPA</b>	172,00	treatment preventing limescale TPA Virgola included
	<b>Screen print</b>	200,00	decors: D50 D51 D52 D54 D55 D60 D61
	<b>Personal Glass</b>	294,00	decors: P13 P15 P16 P19 P56 P70
		ATTENTION	for customized glasses, please always specify if left SX or right DX
<b>Profiles</b>	<b>32</b>	+ 20%	on bright silver 21
	<b>15 / 23 / 38 / 84</b>	+ 25%	on bright silver 21
<b>Special sizes</b>	<b>Lower height</b>	+ 5%	less than cm 195
	<b>Higher height</b>	+ 15%	more than cm 195 (max. cm 205)
	<b>Special width</b>	+ 10% on G2 97	less than cm 97 (min 90 cm)
	<b>Special width</b>	+ 10%	special width fixed element
	<b>Special intermediate sizes</b>	+ 10%	on preceding standard measure

**Product description**

Framed shower enclosure with folding door and an aligned fixed element.

**Characteristics**

It can be assembled with element GF to obtain a corner shower enclosure.

Extensible 60 mm in recess.  
Extensible 45 mm in corner installations.

Double possibility of adjustment, lateral and longitudinal, upon completion of the installation, for an easy final adjustment before sealing

Reversible.

Hinges applied on the doors with flush screws. The inner face of the door is therefore free of obstructions to facilitate cleaning of the glass

The door can be quickly uncoupled and opened outwards for cleaning and safety.

This model is produced without silicon.

PVC seals with magnetic strips.  
Items in matt black 09, moka 38 or metal gun 39 finishing are equipped with black seals.

Product conforming to EN 14428:2018 with CE marking.

**Materials**

Tempered safety glass 6 mm.

Anodised or enamelled aluminium profiles



**Technical specifications**

Price includes one fixing bracket (see page 330 - fixing bracket "G").

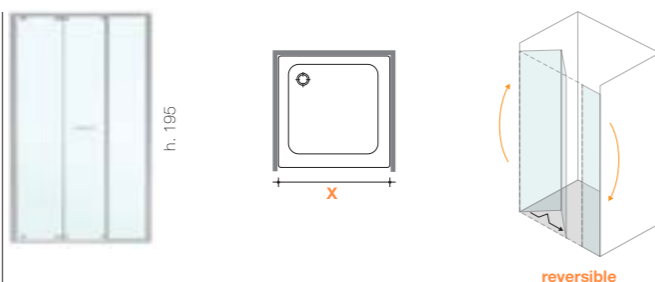

article	boxes	recess dimension X	corner dimension	door dimension cm	opening cm
GM 97	2	97÷103	98÷102,5	60	52
GM 107	2	107÷113	108÷112,5	60	52
GM 117	2	117÷123	118÷122,5	70	57,5
GM 137	2	137÷143	138÷142,5	80	63

04 clear glass

05 Timeless®  
anti-corrosion low maintenance glass

03 clear bronze  
07 clear grey

01 obscure glass  
08 satin glass

06 reflecting  
10 extra-reflex

**STANDARD DIMENSIONS**

codes	dimension of shower tray	profiles	glasses				
GM 97	recess 97 ÷ 103 cm corner 98 ÷ 102,5 cm	31	1.517,00	1.646,00	1.637,00	1.703,00	1.874,00
		21	1.588,00	1.717,00	1.703,00	1.774,00	1.952,00
		09 - 14 - 39	1.746,00	1.875,00	1.900,00	1.971,00	2.155,00
GM 107	recess 107 ÷ 113 cm corner 108 ÷ 112,5 cm	31	1.561,00	1.703,00	1.688,00	1.782,00	1.960,00
		21	1.631,00	1.773,00	1.760,00	1.851,00	2.035,00
		09 - 14 - 39	1.793,00	1.935,00	1.962,00	2.054,00	2.241,00
GM 117	recess 117 ÷ 123 cm corner 118 ÷ 122,5 cm	31	1.604,00	1.758,00	1.743,00	1.859,00	2.042,00
		21	1.672,00	1.826,00	1.814,00	1.927,00	2.120,00
		09 - 14 - 39	1.838,00	1.992,00	2.020,00	2.135,00	2.333,00
GM 137	recess 137 ÷ 143 cm corner 138 ÷ 142,5 cm	31	1.647,00	1.827,00	1.798,00	1.924,00	2.118,00
		21	1.714,00	1.894,00	1.866,00	1.992,00	2.191,00
		09 - 14 - 39	1.884,00	2.063,00	2.079,00	2.208,00	2.409,00

**OPTIONS**

Glass	TPA	205,00	treatment preventing limescale TPA Virgola included
	Screen print	222,00	decors: D50 D51 D52 D54 D55 D60 D61
	Personal Glass	333,00	decors: P13 P15 P16 P19 P56 P70
		ATTENTION	for customized glasses, please always specify if left SX or right DX
Profiles	32	+ 20%	on bright silver 21
	15 / 23 / 38 / 84	+ 25%	on bright silver 21
Special sizes	Lower height	+ 5%	less than cm 195
	Higher height	+ 15%	more than cm 195 (max. cm 205)
	Special width	+ 10% on GM 97	less than cm 97 (min 90 cm)
	Special width	+ 10%	special width fixed element
	Special intermediate sizes	+ 10%	on preceding standard measure

**Product description**

Fixed panel GP for installations on a bath tub or on a low wall.

**Characteristics**

Adjustability **20** mm.

Horizontal and vertical adjustment

To be assembled with  
GN - GA - G2 - GM - GF

Product conforming to EN 14428:2018  
with **CE** marking

**Materials**

Tempered safety glass 8 mm

Anodised or enamelled aluminium profiles.



**Technical specifications**

**The GP panel is always custom made. Please advise the correct dimensions (width and height) and specify if left SX or right DX to the door.**

**Please always attach to the order sheet the technical drawing (from page 340 to page 343)**

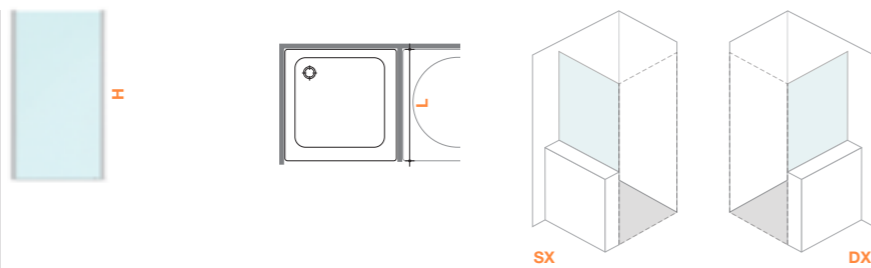

article	boxes	dimension L	dimension H
GP	1	from 60 to 100	from 100 to 170



**Product compatibility with Serie 7200.**

GP model can also be used for small wall configurations for **Serie 7200** collection. In this case it takes the code **ZP** instead of **GP**, but technically the product is identical.

junior  
GP

glasses

<b>04</b> clear glass	<b>05</b> Timeless® anti-corrosion low maintenance glass	<b>03</b> clear bronze <b>07</b> clear grey	<b>01</b> obscure glass <b>08</b> satin glass <b>11</b> cathedral <b>12</b> extra-light	<b>06</b> reflecting <b>10</b> extra-reflex <b>14</b> satin extra-light <b>29</b> madras nuvola
-----------------------	--	--	--	--

**MADE TO MEASURE**

codes	dimension of recess	profiles					
<b>GP 140</b>	+ 20 mm adjustability on item code measure	<b>31</b>	780,00	877,00	896,00	996,00	1.096,00
		<b>21</b>	821,00	918,00	940,00	1.037,00	1.138,00
		<b>09 - 14 - 39</b>	911,00	1.008,00	1.033,00	1.130,00	1.233,00

**OPTIONS**

<b>Glass</b>	<b>TPA</b>	89,00	treatment preventing limescale TPA
	<b>Screen print</b>	133,00	decors: D50 D51 D52 D54 D55 D60 D61
	<b>Personal Glass</b>	200,00	decors: P19 P70
<b>Profiles</b>	<b>32</b>	+ 20%	on bright silver 21
	<b>15 / 23 / 38 / 84</b>	+ 25%	on bright silver 21
<b>Special sizes</b>			

**Custom solutions** These examples below are just indicative. Being customized solutions, it is necessary to submit an enquiry to our Technical Department so to check the feasibility and get an indication of the price.

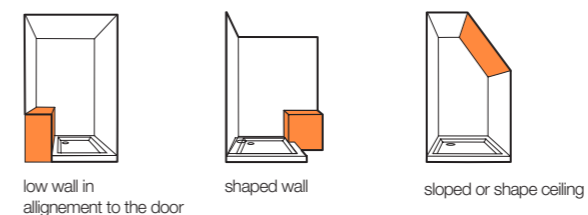

# serie 7200

collection



# serie 7200

The **Serie 7200** comes with new features that improve the appearance without changing the fact that it reflects the production capabilities of Vismaravetro, which expresses all its design skills in this collection. Smaller, more discreet frames enclose panels that slide smoothly on a ball-bearing slider system fixed to the glass and supported by a frame with a reduced size, yet still big enough to support the door without bending.

The return panel has also been enhanced, thanks to a very small profile attached to the glass section that avoids direct sealing between the glass and the shower tray.

Watertightness is guaranteed by the waterstop at the base of the door, which can be omitted for a more linear aesthetic without compromising the enclosure structure.

Repair and everyday cleaning are made easier by the ability to unhook the door and by the technology that enables the doors to be hung from the top rail by means of sliders attached directly to the glass.



The doors hung on the top track through trolleys fixed directly to the glass. In case of large doors larger than 60 cm, the rolleys are doubled to ensure a smooth and light running and with higher weights. The door is guided thanks to a sliding element in the lower gasket easily detachable for a rapidly and daily maintenance

The overlap between door and fixed glass is always kept to a minimum. Few millimeters of overlap are necessary to ensure correct door regulation.



The fixed glass is assembled on an aluminium profile of the same thickness, for easy adjustment and to avoid direct sealing between glass and shower tray.



The door can be disconnected (unhook) for easy maintenance of the shower enclosure. Door can be dislocated approximately 15 cm.



Sliding system. Door's height can be adjusted.

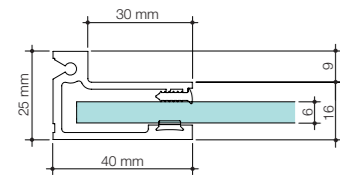

The complete range of Vismaravetro profiles is available upon request at the e-mail [info@vismaravetro.it](mailto:info@vismaravetro.it)



(1) Installation with lower dam profile.



(2) Installation without dam profile at the discretion of the installer, water tightness is reduced and may not comply with the performance required by EN 14428.



A special insert, always included in the packaging, can be added to the corner of the lower profile, to ensure an extraordinary watertight seal.



Handle M4S

serie 7200  
type

recess

ZN



corner

ZA+ZA

ZQ+ZF

ZN+ZG



quadrant

ZT

ZD



3-sided

ZA+ZA+ZG

ZF+ZQ+ZG



side panel

ZN+ZP

ZP element is equal to GP of Junior collection. See page 278/279 for information and prices.



**Product description**

Shower enclosure with sliding door for recess.

**Characteristics**

Extensible **3** cm.

Extension can be increased by **15** mm with the additional profile AD15.

It can be combined with a fixed element ZG for corner solutions. In this combination, the dimension of ZN is increased by **1** cm.

Double possibility of adjustment, lateral and longitudinal.

Ball bearings, fixed directly to the glass.

Magnetic strips.  
Items in matt black **09**, moka **38** or metal gun **39** finishing are equipped with black seals.

Lower profile of extremely reduced size, with the possibility of non-installation in the passage under the door (pay attention as to this assumption the water tightness is reduced)

Vertical adjustment of the door.

Door with releasable system.

This model is assembled without silicon.

Product conforming to EN14428:2018 with **CE** marking.

**Materials**

Tempered safety glass 6 mm.  
Anodised or enamelled aluminium profiles.



**Technical specifications**

Please always specify if **DX** right or **SX** left opening.

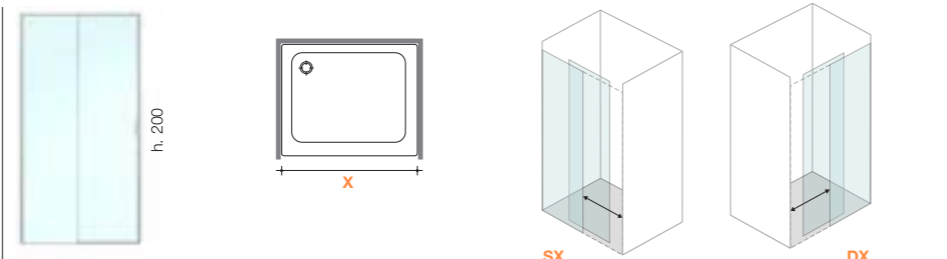

article	boxes	adjustement in recess <b>X</b>	opening
<b>ZN 97</b>	1	96÷102	43
<b>ZN 107</b>	1	106÷112	48
<b>ZN 117</b>	2	116÷122	53
<b>ZN 127</b>	2	126÷132	58
<b>ZN 137</b>	2	136÷142	63
<b>ZN 147</b>	2	146÷152	68
<b>ZN 157</b>	2	156÷162	73
<b>ZN 167</b>	2	166÷172	73
<b>ZN 177</b>	2	176÷182	73

serie 7200  
**ZN**

glasses	<b>04</b> transparente	<b>05</b> Timeless® vidrio anticorrosivo bajo mantenimiento TPA no aplicable	<b>03</b> cristal bronce <b>07</b> cristal gris	<b>01</b> piel naranja <b>08</b> cristal satinado	<b>06</b> reflexivo <b>10</b> extra-reflex
				<b>11</b> katedral <b>12</b> extra-claro	<b>14</b> extra-claro sat.

**STANDARD DIMENSIONS**

codici	dimension of recess	profiles					
<b>ZN 97</b>	recess 97 ÷ 100 cm	<b>31</b>	846,00	978,00	969,00	1.074,00	1.158,00
		<b>21</b>	857,00	987,00	978,00	1.078,00	1.164,00
		<b>09 - 14 - 39 - 61</b>	950,00	1.079,00	1.070,00	1.177,00	1.265,00
<b>ZN 107</b>	recess 107 ÷ 110 cm	<b>31</b>	868,00	1.012,00	1.005,00	1.113,00	1.210,00
		<b>21</b>	879,00	1.021,00	1.013,00	1.121,00	1.217,00
		<b>09 - 14 - 39 - 61</b>	972,00	1.114,00	1.106,00	1.221,00	1.319,00
<b>ZN 117</b>	recess 117 ÷ 120 cm	<b>31</b>	908,00	1.061,00	1.052,00	1.171,00	1.275,00
		<b>21</b>	918,00	1.069,00	1.061,00	1.182,00	1.285,00
		<b>09 - 14 - 39 - 61</b>	1.008,00	1.168,00	1.159,00	1.279,00	1.385,00
<b>ZN 127</b>	recess 127 ÷ 130 cm	<b>31</b>	991,00	1.162,00	1.149,00	1.280,00	1.394,00
		<b>21</b>	1.000,00	1.169,00	1.160,00	1.290,00	1.403,00
		<b>09 - 14 - 39 - 61</b>	1.097,00	1.270,00	1.261,00	1.394,00	1.510,00
<b>ZN 137</b>	recess 137 ÷ 140 cm	<b>31</b>	1.021,00	1.205,00	1.192,00	1.338,00	1.460,00
		<b>21</b>	1.035,00	1.217,00	1.203,00	1.342,00	1.463,00
		<b>09 - 14 - 39 - 61</b>	1.132,00	1.319,00	1.305,00	1.447,00	1.572,00
<b>ZN 147</b>	recess 147 ÷ 150 cm	<b>31</b>	1.061,00	1.259,00	1.245,00	1.394,00	1.526,00
		<b>21</b>	1.069,00	1.269,00	1.255,00	1.403,00	1.533,00
		<b>09 - 14 - 39 - 61</b>	1.177,00	1.376,00	1.363,00	1.514,00	1.647,00
<b>ZN 157</b>	recess 157 ÷ 160 cm	<b>31</b>	1.097,00	1.302,00	1.289,00	1.451,00	1.592,00
		<b>21</b>	1.104,00	1.312,00	1.299,00	1.459,00	1.597,00
		<b>09 - 14 - 39 - 61</b>	1.212,00	1.425,00	1.412,00	1.572,00	1.714,00
<b>ZN 167 (1)</b>	recess 167 ÷ 170 cm	<b>31</b>	1.118,00	1.342,00	1.329,00	1.500,00	1.648,00
		<b>21</b>	1.130,00	1.351,00	1.338,00	1.506,00	1.654,00
		<b>09 - 14 - 39 - 61</b>	1.239,00	1.465,00	1.452,00	1.621,00	1.772,00
<b>ZN 177 (1)</b>	recess 177 ÷ 180 cm	<b>31</b>	1.149,00	1.385,00	1.368,00	1.552,00	1.711,00
		<b>21</b>	1.160,00	1.394,00	1.376,00	1.558,00	1.714,00
		<b>09 - 14 - 39 - 61</b>	1.274,00	1.501,00	1.496,00	1.678,00	1.838,00

(1) door's maximum dimension **78** cm

**Quick delivery items (option Tpa available - see cost of tpa in the extra charges section)**

**OPTIONS**

<b>Glass</b>	<b>TPA</b>	172,00	treatment preventing limescale TPA Virgola included
	<b>Screen print</b>	200,00	decors: D50 D51 D52 D54 D55 D60 D61
	<b>Personal Glass</b>	294,00	decors: P13 P15 P16 P19 P56 P70
<b>Profiles</b>	<b>15 / 32 / 84</b>	+ 25%	on bright silver 21
	<b>Special sizes</b>	<b>Lower height</b>	+ 10% less than cm 200
	<b>Higher height</b>	+ 20% more than cm 200 (max. cm 215)	
	<b>Special width</b>	+ 10% on ZN 96	less than cm 96 (min cm. 92)
	<b>Special intermediate sizes</b>	+ 15%	on preceding standard measure

**Product description**

Sliding door to be combined with fixed panel ZF to obtain a corner shower enclosure.

**Characteristics**

It must be assembled with fixed element ZF.

Extensible **2 cm**.

Extension can be increased by **15 mm** with the additional profile AD15.

The corner shower enclosure ZQ+ZF can be combined to a fixed panel ZG to obtain a 3-sided shower enclosure. In this combination, the dimension of ZQ is increased by **1 cm**.

Magnetic strips.  
Items in matt black **09**, moka **38** or metal gun **39** finishing are equipped with black seals.

Double possibility of adjustment, lateral and longitudinal.

Ball bearings, fixed directly to the glass.

Lower profile of extremely reduced size, with the possibility of non-installation in the passage under the door (pay attention as to this assumption the water tightness is reduced).

Vertical adjustment of the door.

Door with releasable system.

This model is assembled without silicon.

Product conforming to EN14428:2018 with **CE** marking.

**Materials**

Tempered safety glass 6 mm.  
Anodised or enamelled aluminium profiles.



serie 7200  
ZQ

**STANDARD DIMENSIONS**

codici	shower tray dimension	profiles	prices (€)				
ZQ 97	corner 97 ÷ 99 cm	31	758,00	886,00	881,00	978,00	1.066,00
		21	758,00	884,00	879,00	975,00	1.061,00
		09 - 14 - 39 - 61	817,00	946,00	937,00	1.035,00	1.123,00
ZQ 107	corner 107 ÷ 109 cm	31	780,00	921,00	917,00	1.021,00	1.118,00
		21	779,00	918,00	914,00	1.018,00	1.112,00
		09 - 14 - 39 - 61	839,00	981,00	972,00	1.079,00	1.177,00
ZQ 117	corner 117 ÷ 119 cm	31	816,00	969,00	965,00	1.079,00	1.184,00
		21	818,00	970,00	966,00	1.078,00	1.182,00
		09 - 14 - 39 - 61	879,00	1.030,00	1.026,00	1.146,00	1.252,00
ZQ 127	corner 127 ÷ 147 cm	31	912,00	1.079,00	1.074,00	1.197,00	1.311,00
		21	914,00	1.078,00	1.073,00	1.194,00	1.308,00
		09 - 14 - 39 - 61	977,00	1.141,00	1.137,00	1.265,00	1.381,00
ZQ 137	corner 137 ÷ 149 cm	31	951,00	1.131,00	1.122,00	1.259,00	1.381,00
		21	952,00	1.130,00	1.121,00	1.251,00	1.376,00
		09 - 14 - 39 - 61	1.017,00	1.194,00	1.190,00	1.328,00	1.452,00
ZQ 147	corner 147 ÷ 149 cm	31	982,00	1.171,00	1.167,00	1.311,00	1.443,00
		21	982,00	1.169,00	1.164,00	1.308,00	1.437,00
		09 - 14 - 39 - 61	1.048,00	1.239,00	1.234,00	1.381,00	1.514,00
ZQ 157	corner 157 ÷ 159 cm	31	1.012,00	1.214,00	1.205,00	1.363,00	1.504,00
		21	1.013,00	1.212,00	1.208,00	1.360,00	1.497,00
		09 - 14 - 39 - 61	1.079,00	1.283,00	1.279,00	1.434,00	1.576,00
ZQ 167 (1)	corner 167 ÷ 169 cm	31	1.035,00	1.254,00	1.245,00	1.412,00	1.556,00
		21	1.039,00	1.251,00	1.242,00	1.403,00	1.550,00
		09 - 14 - 39 - 61	1.106,00	1.328,00	1.319,00	1.483,00	1.634,00
ZQ 177 (1)	corner 177 ÷ 179 cm	31	1.070,00	1.298,00	1.289,00	1.460,00	1.618,00
		21	1.064,00	1.294,00	1.285,00	1.459,00	1.611,00
		09 - 14 - 39 - 61	1.137,00	1.372,00	1.359,00	1.536,00	1.696,00

(1) door's maximum dimension **78 cm**

Quick delivery items (option Tpa available - see cost of tpa in the extra charges section)



**Technical specifications**

Please always specify if **DX** right or **SX** left opening.

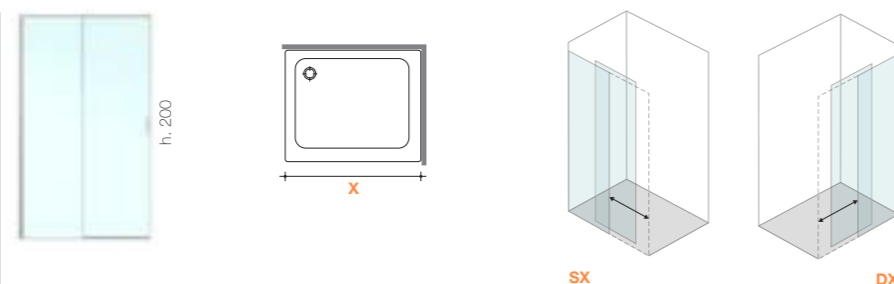

article	boxes	corner adjustment <b>x</b>	opening
ZQ 97	1	97÷99	43
ZQ 107	1	107÷109	48
ZQ 117	2	117÷119	43
ZQ 127	2	127÷129	58
ZQ 137	2	137÷139	63
ZQ 147	2	147÷149	68
ZQ 157	2	157÷159	73
ZQ 167	2	167÷169	73
ZQ 177	2	177÷179	73

**OPTIONS**

Glass	TPA	172,00	treatment preventing limescale TPA Virgola included
	Screen print	200,00	decors: D50 D51 D52 D54 D55 D60 D61
Personal Glass	294,00	decors: P13 P15 P16 P19 P56 P70	
Profiles	<b>15 / 32 / 84</b>	+ 25%	on bright silver 21
Special sizes	Lower height	+ 10%	less than cm 200
	Higher height	+ 20%	more than cm 200 (max. cm 215)
	Special width	+ 10% on ZQ 97	less than cm 97 (min cm. 92)
	Special intermediate sizes	+ 15%	on preceding standard measure

**Product description**

Fixed panel to be combined with door ZQ to obtain a corner shower enclosure.

**Characteristics**

It can be combined exclusively with an element ZQ.

Adjustability **2** cm.

Extension can be increased by **15** mm with the additional profile AD15.

The corner shower enclosure ZQ+ZF can be combined to a fixed panel ZG to obtain a 3-sided shower enclosure. In this combination, the dimension of ZF is increased by **1** cm.

Double possibility of adjustment, lateral and longitudinal, upon completion of the installation, for an easy final adjustment before sealing.

Magnetic closing.

This model is assembled without silicon.

Product conforming to EN14428:2018 with **CE** marking

**Materials**

Tempered safety glass 6 mm.  
Anodised or enamelled aluminium profiles.



**Technical specifications**

Please always specify if **DX** right or **SX** left opening.

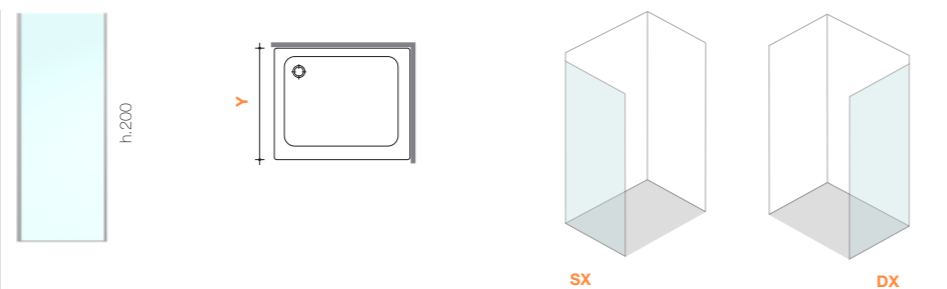

article	boxes	corner adjustment Y
ZF 67	1	67÷69
ZF 72	1	72÷74
ZF 77	1	77÷79
ZF 82	1	82÷84
ZF 87	1	87÷89
ZF 92	1	92÷94
ZF 97	1	97÷99

serie 7200  
ZF

glasses

<b>04</b> transparente	<b>05</b> Timeless® vidrio anticorrosivo bajo mantenimiento TPA no aplicable	<b>03</b> cristal bronce <b>07</b> cristal gris	<b>01</b> piel naranja <b>08</b> cristal satinado <b>11</b> katedral <b>12</b> extra-claro	<b>06</b> reflexivo <b>10</b> extra-reflex <b>14</b> extra-claro sat.
------------------------	---	--	---	---

**STANDARD DIMENSIONS**

codici	shower tray dimension	profiles					
<b>ZF 67</b>	corner 67 ÷ 69 cm	<b>31</b>	478,00	566,00	548,00	627,00	675,00
		<b>21</b>	485,00	572,00	554,00	628,00	679,00
		<b>09 - 14 - 39 - 61</b>	537,00	626,00	608,00	679,00	737,00
<b>ZF 72</b>	corner 72 ÷ 74 cm	<b>31</b>	486,00	583,00	562,00	640,00	702,00
		<b>21</b>	498,00	588,00	567,00	645,00	706,00
		<b>09 - 14 - 39 - 61</b>	546,00	644,00	622,00	702,00	759,00
<b>ZF 77</b>	corner 77 ÷ 79 cm	<b>31</b>	508,00	605,00	583,00	666,00	733,00
		<b>21</b>	515,00	611,00	588,00	675,00	736,00
		<b>09 - 14 - 39 - 61</b>	564,00	666,00	644,00	728,00	795,00
<b>ZF 82</b>	corner 82 ÷ 84 cm	<b>31</b>	517,00	618,00	596,00	684,00	754,00
		<b>21</b>	524,00	624,00	602,00	693,00	758,00
		<b>09 - 14 - 39 - 61</b>	577,00	679,00	657,00	750,00	817,00
<b>ZF 87</b>	corner 87 ÷ 89 cm	<b>31</b>	544,00	654,00	627,00	719,00	794,00
		<b>21</b>	549,00	658,00	632,00	727,00	797,00
		<b>09 - 14 - 39 - 61</b>	604,00	715,00	693,00	790,00	861,00
<b>ZF 92</b>	corner 92 ÷ 94 cm	<b>31</b>	562,00	675,00	649,00	754,00	825,00
		<b>21</b>	567,00	679,00	658,00	754,00	827,00
		<b>09 - 14 - 39 - 61</b>	622,00	741,00	715,00	817,00	892,00
<b>ZF 97</b>	corner 97 ÷ 99 cm	<b>31</b>	571,00	688,00	666,00	771,00	850,00
		<b>21</b>	576,00	697,00	672,00	775,00	852,00
		<b>09 - 14 - 39 - 61</b>	630,00	759,00	733,00	835,00	915,00

Quick delivery items (option Tpa available - see cost of tpa in the extra charges section)

**OPTIONS**

<b>Glass</b>	<b>TPA</b>	105,00	treatment preventing limescale TPA
	<b>Screen print</b>	144,00	decors: D50 D51 D52 D54 D55 D60 D61
	<b>Personal Glass</b>	222,00	decors: P13 P15 P16 P19 P56 P70
<b>Profiles</b>	<b>15 / 32 / 84</b>	+ 25%	on bright silver 21
<b>Special sizes</b>	<b>Lower height</b>	+ 10%	less than cm 200
	<b>Higher height</b>	+ 20%	more than cm 200 (max. cm 215)
	<b>Special width</b>	+ 10% on ZF 67	less than cm 67(min cm. 30)
	<b>Special intermediate sizes</b>	+ 15%	on preceding standard measure

**Product description**

Sliding door for corners.

**Characteristics**

A corner shower enclosure can be obtained combining it with another element ZA.

Extensible 2 cm.

Extension can be increased by 15 mm with the additional profile AD15.

The corner shower enclosure ZA+ZA can be combined to a fixed panel ZG to obtain a 3-sided shower enclosure. In this combination, the dimension of the central ZA is increased by 1 cm.

Double possibility of adjustment, lateral and longitudinal.

Ball bearings, fixed directly to the glass.

Lower profile of extremely reduced size, with the possibility of non-installation in the passage under the door (pay attention as to this assumption the water tightness is reduced).

Magnetic strips.  
Items in matt black 09, moka 38 or metal gun 39 finishing are equipped with black seals.

Vertical adjustment of the door.

Door with releasable system.

This model is assembled without silicon.

Product conforming to EN14428:2018 with CE marking.

**Materials**

Tempered safety glass 6 mm.  
Anodised or enamelled aluminium profiles.



serie 7200  
ZA

glasses

04 trasparente	05 Timeless® vidrio anticorrosivo bajo mantenimiento TPA no aplicable	03 cristal bronce 07 cristal gris	01 piel naranja 08 cristal satinado 11 kathedral 12 extra-claro	06 reflexivo 10 extra-reflex 14 extra-claro sat.
----------------	---	--------------------------------------	--	--

**STANDARD DIMENSIONS**

codici	shower tray dimension	profiles	prices				
<b>ZA 67</b>	67 ÷ 69 cm	31	662,00	746,00	758,00	807,00	890,00
		21	663,00	745,00	761,00	809,00	888,00
		09 - 14 - 39 - 61	710,00	795,00	813,00	861,00	941,00
<b>ZA 72</b>	72 ÷ 74 cm	31	679,00	771,00	785,00	837,00	925,00
		21	684,00	770,00	788,00	840,00	922,00
		09 - 14 - 39 - 61	733,00	821,00	839,00	892,00	977,00
<b>ZA 77</b>	77 ÷ 79 cm	31	702,00	794,00	811,00	868,00	960,00
		21	702,00	797,00	814,00	866,00	957,00
		09 - 14 - 39 - 61	750,00	848,00	866,00	924,00	1.017,00
<b>ZA 82</b>	82 ÷ 84 cm	31	719,00	820,00	841,00	899,00	996,00
		21	723,00	823,00	840,00	896,00	996,00
		09 - 14 - 39 - 61	773,00	875,00	892,00	955,00	1.052,00
<b>ZA 87</b>	87 ÷ 89 cm	31	737,00	841,00	864,00	925,00	1.030,00
		21	736,00	845,00	861,00	922,00	1.026,00
		09 - 14 - 39 - 61	790,00	897,00	915,00	981,00	1.083,00
<b>ZA 92</b>	92 ÷ 94 cm	31	754,00	868,00	886,00	956,00	1.061,00
		21	754,00	866,00	888,00	952,00	1.061,00
		09 - 14 - 39 - 61	808,00	919,00	941,00	1.008,00	1.119,00
<b>ZA 97</b>	97 ÷ 99 cm	31	780,00	899,00	921,00	991,00	1.104,00
		21	784,00	900,00	922,00	991,00	1.104,00
		09 - 14 - 39 - 61	839,00	959,00	981,00	1.052,00	1.168,00
<b>ZA 107 (1)</b>	107 ÷ 109 cm	31	816,00	947,00	969,00	1.048,00	1.171,00
		21	818,00	944,00	970,00	1.043,00	1.169,00
		09 - 14 - 39 - 61	875,00	1.003,00	1.030,00	1.106,00	1.234,00
<b>ZA 117 (1)</b>	117 ÷ 119 cm	31	864,00	1.005,00	1.030,00	1.113,00	1.250,00
		21	861,00	1.000,00	1.026,00	1.112,00	1.247,00
		09 - 14 - 39 - 61	924,00	1.066,00	1.092,00	1.177,00	1.314,00

(1) door's maximum dimension 45 cm

 Quick delivery items (option Tpa available - see cost of tpa in the extra charges section)



**Technical specifications**

Please always specify if DX right or SX left opening.

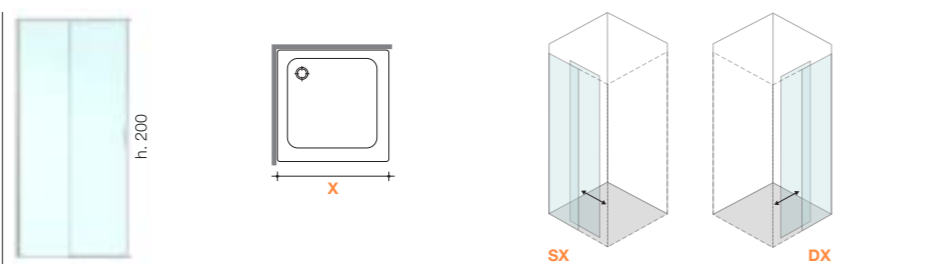

article	boxes	corner adjustment x	opening
<b>ZA 67</b>	1	67÷69	40
<b>ZA 72</b>	1	72÷74	43
<b>ZA 77</b>	1	77÷79	47
<b>ZA 82</b>	1	82÷84	50
<b>ZA 87</b>	1	87÷89	54
<b>ZA 92</b>	1	92÷94	57
<b>ZA 97</b>	1	97÷99	61
<b>ZA 107</b>	2	107÷109	61
<b>ZA 117</b>	2	117÷119	61

OPTIONS			
<b>Glass</b>	<b>TPA</b>	144,00	treatment preventing limescale TPA Virgola included
	<b>Screen print</b>	155,00	decors: D50 D51 D52 D54 D55 D60 D61
	<b>Personal Glass</b>	244,00	decors: P13 P15 P16 P19 P56 P70
<b>Profiles</b>	<b>15 / 32 / 84</b>	+ 25%	on bright silver 21
<b>Special sizes</b>	<b>Lower height</b>	+ 10%	less than cm 200
	<b>Higher height</b>	+ 20%	more than cm 200 (max. cm 215)
	<b>Special width</b>	+ 10% on ZA 67	less than cm 67 (min cm. 60)
	<b>Special intermediate sizes</b>	+ 15%	on preceding standard measure

**Product description**

Additional fixed panel ZG for corner or three sided shower enclosure.

**Characteristics**

It can be combined with an element ZN to obtain a corner shower enclosure or with the corner elements ZQ+ZF and ZA+ZA to obtain 3-sided shower enclosures.

Double possibility of adjustment, lateral and longitudinal.

Extensible **2** cm.

Extension can be increased by **15** mm with the additional profile AD15.

This model is assembled without silicon.

Product conforming to EN 14428:2018 with **CE** marking.

**Materials**

Tempered safety glass 6 mm.

Anodised or enamelled aluminium profiles.



**Technical specifications**

Please always specify if **DX** right or **SX** left opening.

If used for a 3-sided shower enclosure, two fixing brackets must be used (see page 258 - fixing bracket "G").  
To be requested under separate order

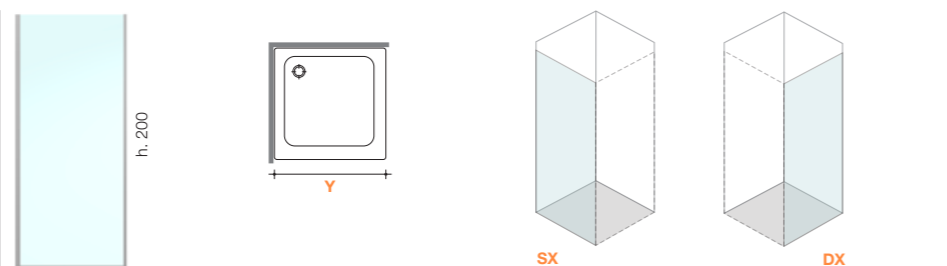

article	boxes	corner adjustment Y
ZG 67	1	67÷69
ZG 72	1	72÷74
ZG 77	1	77÷79
ZG 82	1	82÷84
ZG 87	1	87÷89
ZG 92	1	92÷94
ZG 97	1	97÷99

serie 7200  
**ZG**

glasses	<b>04</b> transparente	<b>05</b> Timeless® vidrio anticorrosivo bajo mantenimiento TPA no aplicable	<b>03</b> cristal bronce	<b>01</b> piel naranja	<b>06</b> reflexivo
			<b>07</b> cristal gris	<b>08</b> cristal satinado	<b>10</b> extra-reflex
				<b>11</b> katedral	<b>14</b> extra-chlaro sat.
				<b>12</b> extra-claro	

**STANDARD DIMENSIONS**

codici	shower tray dimension	profiles					
<b>ZG 67</b>	67 ÷ 69 cm	<b>31</b>	544,00	636,00	592,00	666,00	719,00
		<b>21</b>	549,00	640,00	597,00	672,00	723,00
		<b>09 - 14 - 39 - 61</b>	599,00	693,00	653,00	728,00	781,00
<b>ZG 82</b>	72 ÷ 74 cm	<b>31</b>	553,00	654,00	605,00	684,00	746,00
		<b>21</b>	558,00	654,00	611,00	688,00	745,00
		<b>09 - 14 - 39 - 61</b>	613,00	710,00	666,00	746,00	804,00
<b>ZG 77</b>	77 ÷ 79 cm	<b>31</b>	578,00	684,00	636,00	719,00	780,00
		<b>21</b>	585,00	688,00	640,00	723,00	784,00
		<b>09 - 14 - 39 - 61</b>	639,00	746,00	693,00	781,00	844,00
<b>ZG 82</b>	82 ÷ 84 cm	<b>31</b>	601,00	715,00	662,00	749,00	816,00
		<b>21</b>	606,00	715,00	667,00	754,00	818,00
		<b>09 - 14 - 39 - 61</b>	662,00	773,00	719,00	813,00	879,00
<b>ZG 87</b>	87 ÷ 89 cm	<b>31</b>	627,00	746,00	693,00	785,00	855,00
		<b>21</b>	632,00	749,00	697,00	788,00	861,00
		<b>09 - 14 - 39 - 61</b>	693,00	813,00	755,00	852,00	924,00
<b>ZG 92</b>	92 ÷ 94 cm	<b>31</b>	640,00	763,00	706,00	807,00	881,00
		<b>21</b>	645,00	766,00	710,00	809,00	884,00
		<b>09 - 14 - 39 - 61</b>	702,00	830,00	768,00	870,00	946,00
<b>ZG 97</b>	97 ÷ 99 cm	<b>31</b>	649,00	780,00	719,00	825,00	904,00
		<b>21</b>	654,00	784,00	723,00	827,00	905,00
		<b>09 - 14 - 39 - 61</b>	715,00	844,00	786,00	888,00	950,00

**OPTIONS**

<b>Glass</b>	<b>TPA</b>	105,00	treatment preventing limescale TPA
	<b>Screen print</b>	144,00	decors: D50 D51 D52 D54 D55 D60 D61
	<b>Personal Glass</b>	222,00	decors: P13 P15 P16 P19 P56 P70
<b>Profiles</b>	<b>15 / 32 / 84</b>	+ 25%	on bright silver 21
<b>Special sizes</b>	<b>Lower height</b>	+ 10%	less than cm 200
	<b>Higher height</b>	+ 20%	more than cm 200 (max. cm 215)
	<b>Special width</b>	+ 10% on ZG 67	less than cm 67 (min cm. 30)
	<b>Special intermediate sizes</b>	+ 15%	on preceding standard measure

**Product description**

Shower enclosure with sliding doors for quadrant shower trays (R. 55 cm).

**Characteristics**

Extensible **30** mm each side

Double possibility of adjustment, lateral and longitudinal, upon completion of the installation, for an easy final adjustment before sealing.

Reversible.

Magnetic strips.  
Items in matt black **09**, moka **38** or metal gun **39** finishing are equipped with black seals.

Vertical adjustment of doors.

Rollers with ball bearings.

End stoppers.

Product conforming to EN 14428:2018 with **CE** marking.

**Materials**

Tempered safety glass 6 mm.

Anodised or enamelled aluminium profiles.

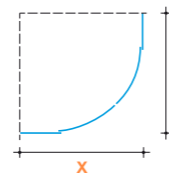

**Technical specifications**

Suitable for quadrant shower trays R. 55 cm.

The radius of the quadrant shower tray must be checked by the customer.

article	boxes	dimensions X	opening	width fixed panels
ZT 80	2	78÷81	44	24
ZT 90	2	88÷91	57	34
ZT 100	2	98÷101	74	44

**Product description**

Shower enclosure with sliding doors for offset quadrant shower trays (R. 38 cm).

**Characteristics**

Extensible **30** mm each side.

Double possibility of adjustment, lateral and longitudinal, upon completion of the installation, for an easy final adjustment before sealing.

Reversible.

Magnetic strips.  
Items in matt black **09**, moka **38** or metal gun **39** finishing are equipped with black seals.

Vertical adjustment of doors.

Rollers with ball bearings.

End stoppers.

Product conforming to EN 14428:2018 with **CE** marking

**Materials**

Tempered safety glass 6 mm.

Anodised or enamelled aluminium profiles.

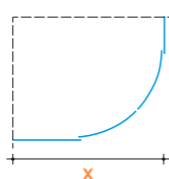

**Technical specifications**

Suitable for quadrant shower trays R. 38 cm.

The radius of the quadrant shower tray must be checked by the customer

article	boxes	dimension short side Y	dimension long side X	opening	width fixed panels short side	width fixed panels long side
ZD 79	2	68÷71	88÷91	50	30	50
ZD 81	2	78÷81	98÷101	50	40	60

**STANDARD DIMENSIONS**

codes	dimension of shower tray	profiles			
ZT 80	shower tray from 78 to 81 cm	14 - 31	1.649,00	1.779,00	2.092,00
		21	1.759,00	1.893,00	2.202,00
		09 - 39 - 61	1.936,00	2.110,00	2.425,00
ZT 90	shower tray from 88 to 91 cm	14 - 31	1.759,00	1.900,00	2.239,00
		21	1.867,00	2.012,00	2.350,00
		09 - 39 - 61	2.056,00	2.242,00	2.590,00
ZT 100	shower tray from 98 to 101 cm	14 - 31	1.867,00	2.018,00	2.388,00
		21	1.974,00	2.128,00	2.499,00
		09 - 39 - 61	2.170,00	2.374,00	2.748,00

Quick delivery items

**OPTIONS**

<b>Glass</b>	<b>TPA</b>	294,00	treatment preventing limescale TPA Virgola included
	<b>Screen print</b>		NOT possible for this model
	<b>Personal Glass</b>		NOT possible for this model
<b>Profiles</b>	<b>15 / 32 / 84</b>	+ 25%	on bright silver 21
<b>Special sizes</b>	<b>Special height</b>		NO special heights
	<b>Special width</b>	+ 15%	special width fixed panels

**STANDARD DIMENSIONS**

codes	dimension of shower tray	profiles			
ZD 79	shower tray short side from 68 to 71 cm long side from 88 to 91 cm	14 - 31	1.813,00	1.945,00	2.260,00
		21	1.930,00	2.063,00	2.378,00
		09 - 39 - 61	2.125,00	2.303,00	2.623,00
ZD 81	shower tray short side from 78 to 81 cm long side from 98 to 101 cm	14 - 31	1.930,00	2.078,00	2.412,00
		21	2.045,00	2.197,00	2.533,00
		09 - 39 - 61	2.249,00	2.449,00	2.792,00

**OPTIONS**

<b>Glass</b>	<b>TPA</b>	294,00	treatment preventing limescale TPA Virgola included
	<b>Screen print</b>		NOT possible for this model
	<b>Personal Glass</b>		NOT possible for this model
<b>Profiles</b>	<b>15 / 32 / 84</b>	+ 25%	on bright silver 21
<b>Special sizes</b>	<b>Special height</b>		NO special heights
	<b>Special width</b>	+ 15%	special width fixed panels

# OTHER SOLUTIONS

bathscreens

pag 298

radiante - heating panel

pag 318

complements

pag 322

# bathscreens

Vismaravetro, with the care it usually takes in producing a bathroom area, has designed Sistemi per Bathscreens, a range of bath screens in tempered glass of different sizes, which are intended to enhance the concept of the use of the bathtub.



bathscreens  
type

	bathscreen 1 side			bathscreen 2 sides
<b>serie 8000</b>	<p><b>VR</b></p> <p>Bathscreen with sliding opening. A third folding panel completes the unit.</p>	<p><b>BN</b></p> <p>Sliding bathscreen with a sliding panel and a fixed one.</p>	<p><b>B4</b></p> <p>Sliding bathscreen with two central sliding panels and two lateral fixed ones.</p>	<p><b>SV+SI</b></p>
<b>sintesi</b>	<p><b>SV</b></p> <p>Frameless bathscreen with folding hinged panel.</p>	<p><b>PV</b></p> <p>Folding bathscreen made by a fixed panel and a folding door.</p>	<p><b>SV+SI</b></p> <p>Frameless bathscreen with folding hinged panel. Corner solutions can be obtained combining a fixed element SI.</p>	
<b>replay</b>	<p><b>SR</b></p> <p>Folding bathscreen made by a plain and a curved panel.</p>		<p><b>SR+SE</b></p> <p>Folding bathscreen made by a plain and a curved panel. Corner solutions can be obtained combining a fixed element SE.</p>	
<b>linea</b>	<p><b>LV</b></p> <p>Frameless shower panel for bathtub with one pivot panel (180°).</p>	<p><b>FB</b></p> <p>Fixed bathscreen.</p>	<p><b>NP</b></p> <p>Frameless bathscreen with folding hinged panel.</p>	<p><b>NP+SI</b></p> <p>Frameless bathscreen with folding hinged panel. Corner solutions can be obtained combining a fixed element SI.</p>
<b>serie F</b>	<p><b>HV</b></p> <p>Frameless folding bathscreen with one hinged pivot panel.</p>			

**Product description**

Bathscreen with sliding opening.  
A third folding panel completes the unit.

**Characteristics**

Adjustability **20** mm, obtained without the extension of the wall profile, which retains its aesthetic.

It can be installed even on bathtub where the taps are placed at the head of the bathtub

No opening space

PVC lower profiles for waterproof.

**S.M.F.**  
(easy mounting system)

Product conforming to EN14428  
with **CE** marking

**Materials**

Anodised aluminium profiles

Tempered glass 8 mm for the fixed panel  
Tempered glass 8 mm for the sliding panel  
Tempered glass 5 mm for the pivot panel



**Technical specifications**

Please always specify left **SX** or right **DX** version.

\* total height 150 cm  
profiles' height 149 cmm

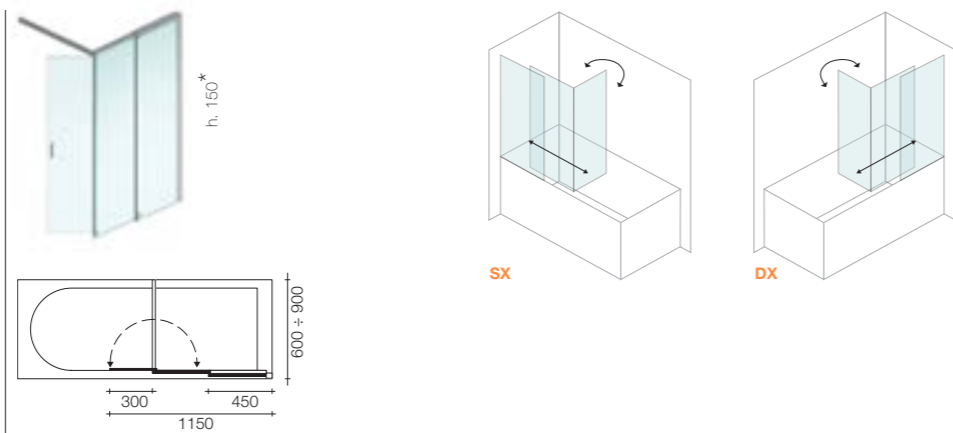

article                  boxes                  dimensions bathscreen

<b>VR</b>	2	60±90
-----------	---	-------

bathscreens  
**VR**

glasses

**04** clear glass

**03** clear bronze  
**07** clear grey

**08** satin glass  
**12** extra-light

**STANDARD DIMENSIONS**

codes	profiles			
<b>VR</b>	<b>31</b>	1.552,00	1.772,00	1.930,00
	<b>21</b>	1.604,00	1.828,00	1.986,00
	<b>09</b>	1.779,00	2.010,00	2.171,00

**OPTIONS**

<b>Glass</b>	<b>TPA</b>	205,00	treatment preventing limescale TPA Virgola included
	<b>Screen print</b>	200,00	decors: D50 D51 D52 D54 D55 D60 D61
	<b>Personal Glass</b>	294,00	decors: P19 P56 P70
<b>Profiles</b>			
<b>Special sizes</b>	<b>Lower height</b>	+ 5%	less than cm 150
	<b>Higher height</b>	+ 15%	more than cm 150 (max cm. 160)
	<b>Special width</b>	+ 20%	special width fixed panel (max cm. 65)

**Custom solutions**

By connecting to the web page shown below, via QR code or by typing the address into your computer browser, you can get information on the custom solutions available for this model and the related additional costs. The examples are just indicative. Being customized solutions, it is necessary to submit an enquiry to our Technical Department so to check the feasibility and get an indication of the price.



[vism.it/LS/LSVR.pdf](http://vism.it/LS/LSVR.pdf)

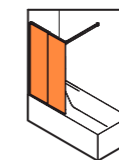

solution without pivot panel

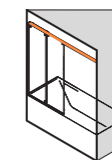

recess solution

patented

**Product description**

Inward gliding bathscreen  
It opens by combining a curved sliding panel and a pivot door.

**Characteristics**

- Extensible 20 mm
- No opening space
- PVC lower profiles for waterproof.

**S.M.F.**  
(easy mounting system)

Product conforming to EN14428  
with **CE** marking

**Materials**

Tempered safety glass 6 mm for curved panel  
Tempered safety glass 8 mm for plain panel

Anodised or enamelled aluminium profiles

Unless specific requests, **SR** bath screens are supplied with standard hinges **C68**.  
The hinge R61 is not suitable to the model SR



**Technical specifications**

Please always specify left **SX** or right **DX** version.

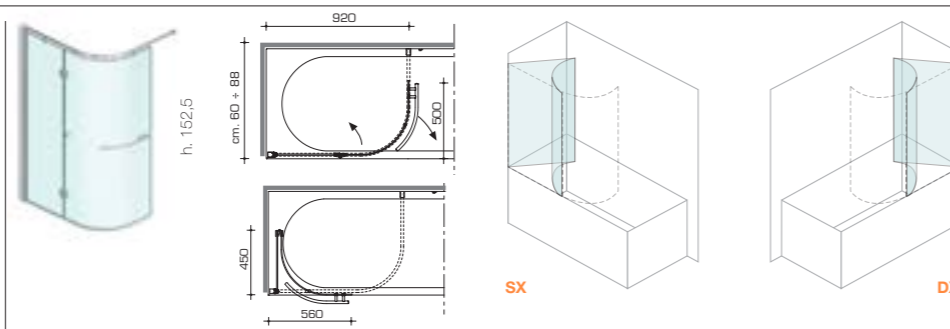

article boxes dimensions bathscreen cm

<b>SR</b>	2	60÷88
-----------	---	-------

bathscreens  
**SR**

glasses 04 clear glass

**STANDARD DIMENSIONS**

codes	profiles	
<b>SR</b>	<b>31</b>	1.567,00
	<b>21</b>	1.616,00
	<b>09 - 14 - 39</b>	1.794,00

<b>OPTIONS</b>			
<b>Glass</b>	<b>TPA</b>	205,00	treatment preventing limescale TPA Virgola included
<b>Profiles</b>	<b>05÷15 / 23 / 32 / 38 / 84</b>	+ 25%	on bright silver 21
<b>Special sizes</b>	<b>Special sizes</b>		no special size

**Product description**

Folding bathscreen made by a pivot panel hinged on a fixed screen.

**Characteristics**

Adjustability **20** mm, obtained without the extension of the wall profile, which retains its aesthetic.

Double possibility of adjustment, lateral and longitudinal.

A fixing bracket is always provided

PVC lower profiles for waterproof

**S.M.F.**

(easily mounting system).

Product conforming to EN14428 with **CE** marking

**Materials**

Tempered glass 6 mm

Anodised or enamelled aluminium profiles

Unless specific requests, **PV** bath screens are supplied with standard hinges:

**C68** (outwards opening)

**C67** (inwards opening)



**Technical specifications**

Please always specify the **DX** right or **SX** left position and if **inwards** or **outwards** open

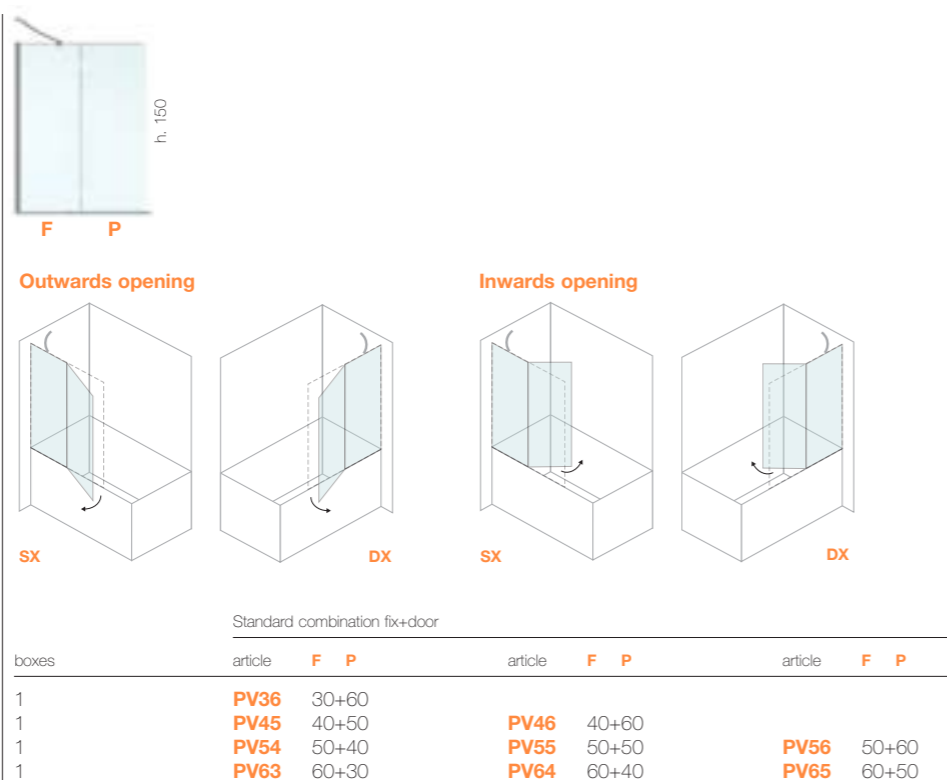

**04** clear glass

**05** Timeless®  
anti-corrosion low  
maintenance glass.  
NO TPA available

**03** clear bronze  
**07** clear grey

**01** obscure glass  
**08** satin glass

**06** reflecting  
**10** extra-reflex

**11** cathedral  
**12** extra-light

**14** satin extra-light  
**29** madras nuvola

**STANDARD DIMENSIONS**

codes	element's dimension	profiles					
<b>PV 36</b>	90 ÷ 92 cm	<b>31</b>	876,00	962,00	996,00	1.099,00	1.210,00
<b>PV 45</b>	90 ÷ 92 cm	<b>21</b>	924,00	1.010,00	1.050,00	1.151,00	1.269,00
<b>PV 54</b>	90 ÷ 92 cm	<b>09 - 14 - 39</b>	1.028,00	1.114,00	1.158,00	1.261,00	1.378,00
<b>PV 63</b>	90 ÷ 92 cm		<b>31</b>	931,00	1.018,00	1.077,00	1.190,00
<b>PV 46</b>	100 ÷ 102 cm	<b>21</b>	985,00	1.071,00	1.127,00	1.244,00	1.369,00
<b>PV 55</b>	100 ÷ 102 cm	<b>09 - 14 - 39</b>	1.093,00	1.180,00	1.240,00	1.359,00	1.485,00
<b>PV 64</b>	100 ÷ 102 cm		<b>31</b>	991,00	1.078,00	1.154,00	1.284,00
<b>PV 56</b>	110 - 112 cm	<b>21</b>	1.046,00	1.132,00	1.207,00	1.336,00	1.472,00
<b>PV 65</b>	110 - 112 cm	<b>09 - 14 - 39</b>	1.162,00	1.249,00	1.326,00	1.460,00	1.595,00



**Important:**  
Always specify the **DX** right or **SX** left position and if **inwards** or **outwards** open

**OPTIONS**

<b>Glass</b>	<b>TPA</b>	161,00	treatment preventing limescale TPA Virgola included
	<b>Screen print</b>	155,00	decors: D50 D51 D52 D54 D55 D60 D61
	<b>Personal Glass</b>	244,00	decors: P56 P70
<b>Profiles</b>	<b>32</b>	+ 20%	on bright silver 21
	<b>05÷15 / 23 / 33 / 38 / 84</b>	+ 25%	on bright silver 21
<b>Special sizes</b>	<b>Lower height</b>	+ 5%	less than cm 150
	<b>Higher height</b>	+ 15%	more than cm 150 (max cm. 160)
	<b>Special width</b>	+ 10%	special combinations door/fixe

**Custom solutions**

By connecting to the web page shown below, via QR code or by typing the address into your computer browser, you can get information on the custom solutions available for this model and the related additional costs. The examples are just indicative. Being customized solutions, it is necessary to submit an enquiry to our Technical Department so to check the feasibility and get an indication of the price.



[vism.it/L/LSPV.pdf](http://vism.it/L/LSPV.pdf)



shaped wall

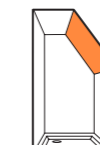

sloped or shape ceiling

**Product description**

Frameless bathscreen with folding panels.

**Characteristics**

- Extensible **20** mm
- Both panels fold completely back and lean against the wall
- PVC lower profile for waterproof

**S.M.F.**  
(easily mounting system).

Product conforming to EN14428 with **CE** marking

**Materials**

- Tempered glass 6 mm.
- Anodised or enamelled aluminium profiles



**Technical specifications**

Please always specify left **SX** or right **DX** version.

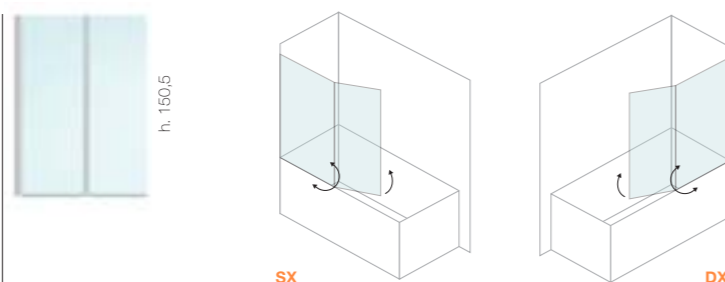

article	boxes	dimensions cm
<b>NP 60</b>	1	60+50
<b>NP 65</b>	1	65+55

- 04** clear glass
- 05** Timeless® anti-corrosion low maintenance glass. NO TPA available
- 03** clear bronze
- 01** obscure glass
- 06** reflecting
- 07** clear grey
- 08** satin glass
- 10** extra-reflex
- 11** cathedral
- 14** satin extra-light
- 12** extra-light
- 29** madras nuvola

**STANDARD DIMENSIONS**

codes	element's dimension	profiles					
<b>NP 60</b>	110 - 112 cm	<b>31</b>	785,00	891,00	931,00	1.063,00	1.171,00
		<b>21</b>	823,00	929,00	975,00	1.106,00	1.218,00
		<b>09 - 14 - 39 - 61</b>	915,00	1.021,00	1.071,00	1.202,00	1.314,00
<b>NP 65</b>	120 - 122 cm	<b>31</b>	831,00	938,00	1.006,00	1.149,00	1.265,00
		<b>21</b>	877,00	983,00	1.049,00	1.190,00	1.312,00
		<b>09 - 14 - 39 - 61</b>	972,00	1.079,00	1.151,00	1.292,00	1.415,00

Quick delivery items

**OPTIONS**

<b>Glass</b>	<b>TPA</b>	161,00	treatment preventing limescale TPA Virgola included
	<b>Screen print</b>	155,00	decors: D50 D51 D52 D54 D55 D60 D61
	<b>Personal Glass</b>	244,00	decors: P32 P56 P70
<b>Profiles</b>	<b>32</b>	+ 20%	on bright silver 21
	<b>05÷15 / 23 / 33 / 38 / 84</b>	+ 25%	on bright silver 21
<b>Special sizes</b>	<b>Lower height</b>	+ 5%	less than cm 150,5
	<b>Higher height</b>	+ 15%	more than cm 150,5 (max cm. 160)
	<b>Special width</b>	+ 10% on NP 60	less than cm 110
	<b>Special width</b>	+ 10% on NP 65	larger than 120 cm (max 130)

**Custom solutions**

By connecting to the web page shown below, via QR code or by typing the address into your computer browser, you can get information on the custom solutions available for this model and the related additional costs. The examples are just indicative. Being customized solutions, it is necessary to submit an enquiry to our Technical Department so to check the feasibility and get an indication of the price.



[vism.it/LS/LSNP.pdf](http://vism.it/LS/LSNP.pdf)



sloped or shape ceiling



shower element compatible with the need of people with reduced mobility

**Product description**

Frameless bathscreen with folding hinged panel.

**Characteristics**

- Extensible 20 mm
- Both panels fold completely back and lean against the wall
- PVC lower profile for waterproof

**S.M.F.**  
(easily mounting system).

Product conforming to EN14428 with **CE** marking

**Materials**

- Tempered glass 6 mm.
- Anodised or enamelled aluminium profiles
- Unless specific requests, **SV** bath screens are supplied with standard hinges **C68**. The hinge R61 is not suitable to the model SV



**Technical specifications**

Please always specify left **SX** or right **DX** version.

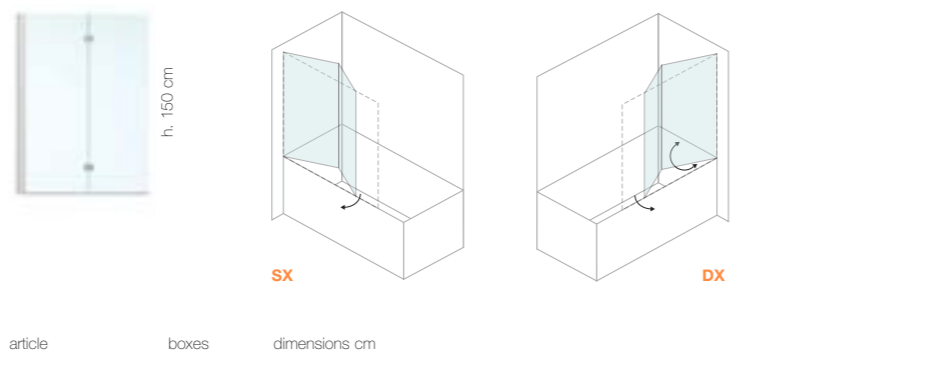

article	boxes	dimensions cm
<b>SV 60</b>	1	60+50

bathscreens  
**SV**

glasses

- 04** clear glass
- 05** Timeless® anti-corrosion low maintenance glass. NO TPA available
- 03** clear bronze
- 01** obscure glass
- 06** reflecting
- 07** clear grey
- 08** satin glass
- 10** extra-reflex
- 11** cathedral
- 14** satin extra-light
- 12** extra-light
- 29** madras nuvola

**STANDARD DIMENSIONS**

codes	element's dimension	profiles				
<b>SV 60</b>	110 - 112 cm	<b>31</b>	972,00	1.079,00	1.134,00	1.291,00
		<b>21</b>	1.039,00	1.146,00	1.199,00	1.359,00
		<b>09 - 14 - 39</b>	1.151,00	1.258,00	1.319,00	1.477,00

**Quick delivery items (option Tpa available - see cost of tpa in the extra charges section)**

**OPTIONS**

<b>Glass</b>	<b>TPA</b>	161,00	treatment preventing limescale TPA Virgola included
	<b>Screen print</b>	155,00	decors: D50 D51 D52 D54 D55 D60 D61
	<b>Personal Glass</b>	244,00	decors: P32 P56 P70
<b>Profiles</b>	<b>32</b>	+ 20%	on bright silver 21
	<b>05÷15 / 23 / 33 / 38 / 84</b>	+ 25%	on bright silver 21
<b>Special sizes</b>	<b>Lower height</b>	+ 5%	less than cm 150,5
	<b>Higher height</b>	+ 15%	more than cm 150,5 (max cm. 160)
	<b>Special width</b>	+ 10%	less than cm 110
	<b>Special width</b>	+ 10%	larger than 110 cm (max 130)

**Custom solutions** By connecting to the web page shown below, via QR code or by typing the address into your computer browser, you can get information on the custom solutions available for this model and the related additional costs. The examples are just indicative. Being customized solutions, it is necessary to submit an enquiry to our Technical Department so to check the feasibility and get an indication of the price.



[vism.it/LS/LSSV.pdf](http://vism.it/LS/LSSV.pdf)



sloped or shape ceiling



shower element compatible with the need of people with reduced mobility

**Product description**

Fixed panel for bathtub

**Characteristics**

- Extensible **20** mm
- Horizontal and vertical adjustment
- Equipped with an "Q" fixing bracket
- To be assembled with SR (SE)
- To be assembled with SV and NP (SI)

**S.M.F.**  
(easily mounting system)

Product conforming to EN14428 with **CE** marking

**Materials**

- Tempered glass 8 mm
- Anodised or enamelled aluminium profiles



**Technical specifications**

Please always specify left **SX** or right **DX** version.  
Please always advise the exact dimension of the installed bathtub.

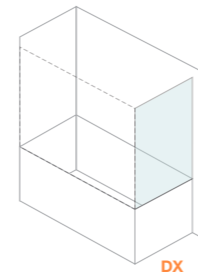
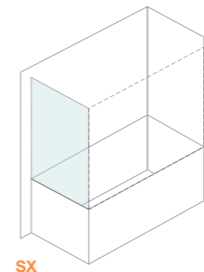

article	boxes	height H
<b>SE</b>	1	152,5
<b>SI</b>	1	150,5

<b>04</b> clear glass	<b>05</b> Timeless® anti-corrosion low maintenance glass. <b>NO TPA</b> available	<b>03</b> clear bronze	<b>01</b> obscure glass	<b>06</b> reflecting
		<b>07</b> clear grey	<b>08</b> satin glass	<b>10</b> extra-reflex
			<b>11</b> cathedral	<b>14</b> satin extra-light
			<b>12</b> extra-light	<b>29</b> madras nuvola

**MADE TO MEASURE**

codes	dimension bathtub	profiles					
<b>SE 67 ... SE 89</b>	+ 20 mm adjustability on item code measure	<b>31</b>	910,00	997,00			
		<b>21</b>	960,00	1.047,00			
		<b>09 - 14 - 39</b>	1.064,00	1.151,00			
<b>SI 67 ... SI 89</b>	+ 20 mm adjustability on item code measure	<b>31</b>	910,00	997,00	1.029,00	1.126,00	1.239,00
		<b>21</b>	960,00	1.047,00	1.081,00	1.177,00	1.291,00
		<b>09 - 14 - 39</b>	1.064,00	1.151,00	1.191,00	1.286,00	1.403,00

**OPTIONS**

<b>Glass</b>	<b>TPA</b>	89,00	treatment preventing limescale TPA
	<b>Screen print</b>	133,00	decors: D50 D51 D52 D54 D55 D60 D61
	<b>Personal Glass</b>	200,00	decors: P56 P70
<b>Profiles</b>	<b>32</b>	+ 20%	on bright silver 21
	<b>05÷15 / 23 / 33 / 38 / 84</b>	+ 25%	on bright silver 21
<b>Special sizes</b>	<b>Lower height</b>	+ 5%	less than cm 150,5 (solo SI)
	<b>Higher height</b>	+ 15%	more than cm 150,5 (max. cm 160) (solo SI)
	<b>Special width</b>	no extra charge	less than cm 67 (min cm 30)
Attention to the need of installing a stabilizer bar			

**Product description**

Fixed bathscreen

**Characteristics**

- Extensible **15** mm
- Horizontal and vertical adjustment
- Product conforming to EN14428 with **CE** marking.
- A fixing bracket Q is always provided

**Materials**

- Tempered glass 8 mm
- Anodised or enamelled aluminium profiles

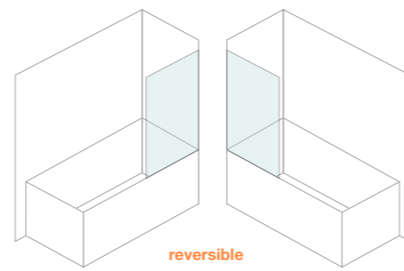

article	boxes	dimensions cm
<b>FB 70</b>	1	70÷71,5
<b>FB 80</b>	1	80÷81,5
<b>FB 90</b>	1	90÷91,5

<b>04</b> clear glass	<b>05</b> Timeless® anti-corrosion low maintenance glass. <b>NO TPA</b> available	<b>03</b> clear bronze	<b>01</b> obscure glass	<b>06</b> reflecting
		<b>07</b> clear grey	<b>08</b> satin glass	<b>10</b> extra-reflex
			<b>11</b> cathedral	<b>14</b> satin extra-light
			<b>12</b> extra-light	<b>29</b> madras nuvola

**STANDARD DIMENSIONS**

codes	element's dimension	profiles					
<b>FB 70</b>	70 - 71,5 cm	<b>31</b>	474,00	542,00	556,00	636,00	714,00
		<b>21</b>	495,00	563,00	577,00	655,00	733,00
		<b>09 - 14 - 39 - 61</b>	548,00	616,00	635,00	713,00	789,00
<b>FB 80</b>	80 - 81,5 cm	<b>31</b>	496,00	564,00	592,00	686,00	767,00
		<b>21</b>	514,00	582,00	611,00	703,00	785,00
		<b>09 - 14 - 39 - 61</b>	572,00	639,00	670,00	764,00	848,00
<b>FB 90</b>	90 - 91,5 cm	<b>31</b>	515,00	583,00	625,00	733,00	821,00
		<b>21</b>	536,00	604,00	644,00	753,00	842,00
		<b>09 - 14 - 39 - 61</b>	593,00	660,00	706,00	816,00	907,00

Quick delivery item

**OPTIONS**

<b>External towel holder</b>		<b>PST - PSR</b>	see page 326 for information and prices
<b>Glass</b>	<b>TPA</b>	117,00	treatment preventing limescale TPA Virgola included
	<b>Screen print</b>	133,00	decors: D60 D61
	<b>Personal Glass</b>	200,00	decors: P56 P70
<b>Profiles</b>	<b>32</b>	+ 20%	on bright silver 21
	<b>05÷15 / 23 / 38 / 84</b>	+ 25%	on bright silver 21
<b>Special sizes</b>	<b>Lower height</b>	+ 5%	less than cm 150
	<b>Higher height</b>	+ 10%	more than cm 150 (max cm. 160)
	<b>Special width</b>	no extra charge	less than cm 70 (min cm 30)

**Product description**

Frameless shower panel for bathtub with one pivot panel (180°)

**Characteristics**

Extensible **20** mm.

Double possibility of adjustment, lateral and longitudinal, upon completion of the installation, for an easy final adjustment before sealing.

Inward and outward opening

**S.M.F.**  
(easily mounting system)

Product conforming to EN14428 with **CE** marking

**Materials**

Tempered glass 6 mm

Anodised or enamelled aluminium profiles

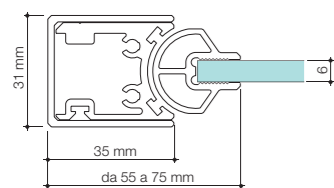

**Technical specifications**

Please always specify left **SX** or right **DX** version.

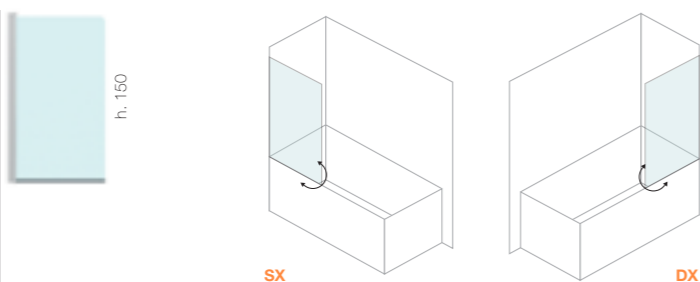

article	boxes	dimensions cm
<b>LV 70</b>	1	70÷72
<b>LV 80</b>	1	80÷82
<b>LV 90</b>	1	90÷92

<b>04</b> clear glass	<b>05</b> Timeless® anti-corrosion low maintenance glass. NO TPA available	<b>03</b> clear bronze	<b>01</b> obscure glass	<b>06</b> reflecting
		<b>07</b> clear grey	<b>08</b> satin glass	<b>10</b> extra-reflex
			<b>11</b> cathedral	<b>14</b> satin extra-light
			<b>12</b> extra-light	<b>29</b> madras nuvola

**STANDARD DIMENSIONS**

codes	element's dimension	profiles	prices				
<b>LV 70</b>	70 - 72 cm	<b>31</b>	658,00	726,00	753,00	830,00	916,00
		<b>21</b>	703,00	770,00	797,00	875,00	963,00
		<b>09 - 14 - 39 - 61</b>	781,00	849,00	876,00	957,00	1.047,00
<b>LV 80</b>	80 - 82 cm	<b>31</b>	687,00	755,00	791,00	889,00	977,00
		<b>21</b>	729,00	797,00	835,00	931,00	1.025,00
		<b>09 - 14 - 39 - 61</b>	810,00	878,00	918,00	1.015,00	1.110,00
<b>LV 90</b>	90 - 92 cm	<b>31</b>	717,00	785,00	830,00	942,00	1.036,00
		<b>21</b>	759,00	827,00	875,00	988,00	1.086,00
		<b>09 - 14 - 39 - 61</b>	842,00	910,00	963,00	1.076,00	1.174,00

Quick delivery items

**OPTIONS**

<b>External towel holder</b>	<b>TPA</b>	<b>PST - PSR</b>	see page 326 for information and prices
<b>Glass</b>	<b>Screen print</b>		117,00 treatment preventing limescale TPA Virgola included
	<b>Personal Glass</b>		133,00 decors: D50 D51 D52 D54 D55 D60 D61
			200,00 decors: P30 P32 P56 P70
<b>Profiles</b>	<b>32</b>		+ 20% on bright silver 21
	<b>05÷15 / 23 / 33 / 38 / 52 / 84</b>		+ 25% on bright silver 21
	<b>34</b> rame satinato / <b>35</b> oro matt		938,00 on bright silver 21
<b>Special sizes</b>	<b>Lower height</b>		+ 5% less than cm 150
	<b>Higher height</b>		+ 15% more than cm 150 (max cm. 160)
	<b>Special width</b>		no extra charge less than cm 70 (min cm 30)

**Custom solutions**

By connecting to the web page shown below, via QR code or by typing the address into your computer browser, you can get information on the custom solutions available for this model and the related additional costs. The examples are just indicative. Being customized solutions, it is necessary to submit an enquiry to our Technical Department so to check the feasibility and get an indication of the price.



[vism.it/LS/LSLV.pdf](http://vism.it/LS/LSLV.pdf)



sloped or shape ceiling



shower element compatible with the need of people with reduced mobility

**Product description**

Frameless folding bathscreen with one hinged pivot panel.

**Characteristics**

Made to measure to millimetre precision.

No adjustment is possible.

The walls of the recess must be of masonry construction and perfectly plumb.

Brass hinges with inward and outward opening.

Items in matt black **09** or metal gun **39** finishing are equipped with black seals.

An additional water-stop profile is supplied in the package, which can be used on the edge of the bathtub in order to achieve the best seal.

Maximum width up to 100 cm can be achieved with the addition of a third hinge.  
(see chart on page 054))

SIS™ Simple Installation System.

**Materials**

Tempered glass 8 mm.

Brass hinges

Anodised or enamelled aluminium profiles.



bathscreens

HV

glasses

**04** clear glass

**05** Timeless®  
anti-corrosion low  
maintenance glass.  
NO TPA available

**03** clear bronze  
**07** clear grey

**01** obscure glass  
**08** satin glass

**06** reflecting  
**10** extra-reflex

**11** cathedral  
**12** extra-light

**14** satin extra-light  
**29** madras nuvola

**MADE TO MEASURE to the mm**

codici	bathscreen	hinges and accessories						
<b>width</b>	<b>from 550 to 700 mm</b>	<b>21 31</b>	989,00	989,00	1.118,00	1.194,00	1.329,00	
		<b>14 15 09 39 61</b>	1.058,00	1.058,00	1.188,00	1.267,00	1.401,00	
			<b>23 32 33 38 73 84</b>	1.243,00	1.243,00	1.351,00	1.430,00	1.563,00
			<b>34 35 54</b>	1.459,00	1.459,00	1.568,00	1.648,00	1.783,00
<b>width</b>	<b>from 701 to 900 mm</b>	<b>21 31</b>	1.040,00	1.040,00	1.200,00	1.326,00	1.461,00	
		<b>09 14 15 39 61</b>	1.108,00	1.108,00	1.270,00	1.396,00	1.534,00	
			<b>23 32 33 38 73 84</b>	1.294,00	1.294,00	1.432,00	1.561,00	1.697,00
			<b>34 35 54</b>	1.511,00	1.511,00	1.651,00	1.780,00	1.916,00



**Technical specifications**

The height of the element HV is always custom made. Prices refer to height between 1400 and 1600 mm.

If a specific height is not given, the element is supplied 1500 mm high.

Unless specific requests, bathscreen HV is supplied without any knob or handle.

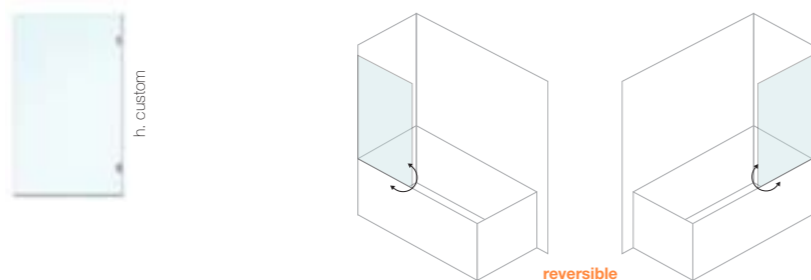

article	boxes	dimensions
<b>HV 550÷900</b>	1	Bathscreen "HV" is always custom made (mm by mm).  No adjustments are possible

**OPTIONS**

<b>External towel holder</b>	<b>PST - PSR</b>	see page 326 for information and prices
<b>Knob</b>	<b>POT</b>	92,00 solution with drilled hole (see page 056 for information)
<b>Glass</b>	<b>TPA</b>	133,00 TPA anti-limescale treatment with Virgola included
	<b>Serigrafie</b>	133,00 decors: D50 D51 D52 D54 D55 D60 D61
	<b>Personal Glass</b>	200,00 decors: P13 P15 P16 P19 P30 D56 D70
<b>Special sizes</b>	see chart on page 054 for feasibility	+ 20% special sizes may require a third hinge

**Product description**

Sliding bath screen, for recess bathtubs.  
One sliding door and in line fixed panel.

**Characteristics**

Adjustability **30** mm, obtained without the extension of the wall profile, which retains its aesthetic.

Optional compact wall profile **AS10** - supplied under separate order (ATTENTION: adjustability reduced to only 20 mm)

Vertical PVC seals with magnetic strips. Items in matt black **09**, moka **38** or metal gun **39** finishing are equipped with black seals.

Horizontal and vertical adjustment.

**S.M.F.**  
(easy mounting system)

Door with releasable system.

Ball bearings

Product conforming to EN14428:2018 with **CE** marking

**Materials**

Tempered glass 8 mm

Anodised or enamelled aluminium profiles



**Technical specifications**

Please always advise the exact dimensions of the recess **X** and specify if **DX** right or **SX** left opening.

\* total height 150 cm  
profiles' height 149 cm

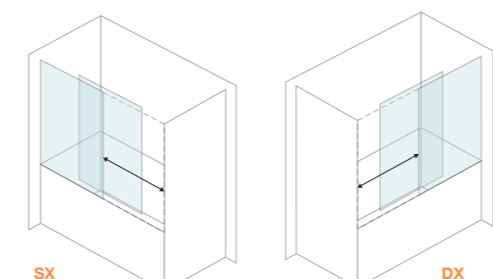

article	boxes	dimension of recess X	
<b>BN 140÷179</b>	3	Bath screen "BN" is always custom made (cm by cm).	Ex: <b>BN 155</b> = bath screen for recess between cm 155 and 158.

**Product description**

Sliding bath screen, for recess bathtubs.  
Two central sliding doors and two fixed in line panels.

**Characteristics**

Adjustability **60** mm, obtained without the extension of the wall profile, which retains its aesthetic.

Optional compact wall profile **AS10** - supplied under separate order (ATTENTION: adjustability reduced to only 40 mm)

Vertical PVC seals with magnetic strips. Items in matt black **09**, moka **38** or metal gun **39** finishing are equipped with black seals.

Horizontal and vertical adjustment.

**S.M.F.**  
(easy mounting system)

Doors with releasable system.

Ball bearings

Product conforming to EN14428:2018 with **CE** marking

**Materials**

Tempered glass 8 mm

Anodised or enamelled aluminium profiles



**Technical specifications**

Please always advise the exact dimensions of the recess **X**

\* total height 150 cm  
profiles' height 149 cm

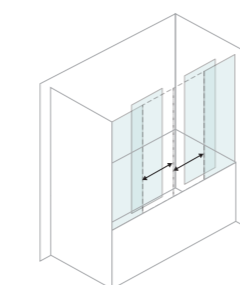

article	boxes	dimension of recess X	
<b>B4 158÷219</b>	5	Bath screen "B4" is always custom made (cm by cm).	Ex: <b>B4 185</b> = bath screen for recess between cm 185 and 191.

<b>04</b> clear glass	<b>05</b> Timeless® anti-corrosion low maintenance glass. NO TPA available	<b>03</b> clear bronze	<b>01</b> obscure glass	<b>06</b> reflecting
		<b>07</b> clear grey	<b>08</b> satin glass	<b>10</b> extra-reflex
			<b>11</b> cathedral	<b>14</b> satin extra-light
			<b>12</b> extra-light	<b>29</b> madras nuvola

**MADE TO MEASURE**

codes	dimension bathtub	profiles					
<b>BN 140 ... BN 159</b>	+ 30 mm adjustability on item code measure	<b>31</b>	1.188,00	1.341,00	1.325,00	1.447,00	1.594,00
		<b>21</b>	1.219,00	1.372,00	1.355,00	1.480,00	1.627,00
		<b>09 - 14 - 39 - 61</b>	1.354,00	1.507,00	1.493,00	1.618,00	1.768,00
<b>BN 160 ... BN 179</b>	+ 30 mm adjustability on item code measure	<b>31</b>	1.240,00	1.393,00	1.385,00	1.523,00	1.675,00
		<b>21</b>	1.268,00	1.421,00	1.415,00	1.552,00	1.709,00
		<b>09 - 14 - 39 - 61</b>	1.406,00	1.560,00	1.558,00	1.696,00	1.855,00

**OPTIONS**

<b>Glass</b>	<b>TPA</b>	172,00	treatment preventing limescale TPA Virgola included
	<b>Screen print</b>	200,00	decors: D50 D51 D52 D54 D55 D60 D61
	<b>Personal Glass</b>	294,00	decors: P32 P56 P70
<b>Profiles</b>	<b>Aluminium magnetic profile</b>	111,00	magnetic strip in aluminium profile
	<b>32</b>	+ 20%	on bright silver 21
	<b>05÷15 / 23 / 33 / 38 / 84</b>	+ 25%	on bright silver 21
	<b>34</b> matt copper / <b>35</b> matt gold	1.604,00	on bright silver 21
<b>Special sizes</b>	<b>Lower height</b>	+ 10%	less than cm 150

<b>04</b> clear glass	<b>05</b> Timeless® anti-corrosion low maintenance glass. NO TPA available	<b>03</b> clear bronze	<b>01</b> obscure glass	<b>06</b> reflecting
		<b>07</b> clear grey	<b>08</b> satin glass	<b>10</b> extra-reflex
			<b>11</b> cathedral	<b>14</b> satin extra-light
			<b>12</b> extra-light	<b>29</b> madras nuvola

**MADE TO MEASURE**

codes	dimension bathtub	profiles					
<b>B4 158 ... B4 177</b>	+ 60 mm adjustability on item code measure	<b>31</b>	2.243,00	2.414,00	2.544,00	2.762,00	3.039,00
		<b>21</b>	2.277,00	2.448,00	2.580,00	2.801,00	3.080,00
		<b>09 - 14 - 39 - 61</b>	2.531,00	2.702,00	2.840,00	3.062,00	3.349,00
<b>B4 178 ... B4 197</b>	+ 60 mm adjustability on item code measure	<b>31</b>	2.332,00	2.503,00	2.657,00	2.908,00	3.199,00
		<b>21</b>	2.367,00	2.537,00	2.697,00	2.949,00	3.242,00
		<b>09 - 14 - 39 - 61</b>	2.628,00	2.799,00	2.969,00	3.223,00	3.520,00
<b>B4 198 ... B4 219</b>	+ 60 mm adjustability on item code measure	<b>31</b>	2.421,00	2.592,00	2.776,00	3.056,00	3.361,00
		<b>21</b>	2.458,00	2.628,00	2.816,00	3.094,00	3.403,00
		<b>09 - 14 - 39 - 61</b>	2.729,00	2.900,00	3.098,00	3.378,00	3.690,00

**OPTIONS**

<b>Glass</b>	<b>TPA</b>	261,00	treatment preventing limescale TPA Virgola included
	<b>Screen print</b>	239,00	decors: D50 D51 D52 D54 D55 D60 D61
	<b>Personal Glass</b>	361,00	decors: P32 P56 P70
<b>Profiles</b>	<b>Aluminium magnetic profile</b>	216,00	magnetic strip in aluminium profile
	<b>32</b>	+ 20%	on bright silver 21
	<b>05÷15 / 23 / 33 / 38 / 84</b>	+ 25%	on bright silver 21
	<b>34</b> matt copper / <b>35</b> matt gold	2.004,00	on bright silver 21
<b>Special sizes</b>	<b>Lower height</b>	+ 5%	less than cm 150
	<b>Special width</b>	+ 10% on B4 158	less than cm 158 (min. cm 140)

# radiante - heating panel

**Radiante** is a fixed glass panel that emits heat. Paired with various types of doors, it creates a "heated" shower enclosure. In addition to providing the utmost comfort inside the shower, **Radiante** also heats the bathroom, intensifying and at times even replacing the classic radiator or traditional heating systems.

The glass panel that forms the radiating wall is composed of two sheets of tempered, layered glass. Heat is generated by an electric current inside the panel, which is protected by double insulation around its edges. The above system complies with all safety requirements approved by EU certification authorities. Vismaravetro holds an EU patent for the innovative technical solutions used to power the panel while ensuring conditions of maximum safety as required by the above standards.



Product certified by IMQ a that guarantees the safety and the quality.



#### Installation:

the electrical equipment should be mounted on an already installed and prepared fixed wall and must be installed by an electrician, who is required to oversee connection to an external power supply following the upstream installation of a two-way safety switch.

#### Adjustment:

The option of setting 4 power levels for surface temperatures of 44° - 48° - 52° - 56° C. Temperature is regulated using a sensor applied to the glass surface, which electronically regulates the electric current and maintains the pre-set temperature. Another sensor detects overheating and can automatically shut off power.

#### Options:

Installation of a timer for turning heat on and off. Installation of a connection to an ambient thermostat that can regulate room temperature and also be controlled electronically.

radiante  
heating panel

#### Preparation of the power supply point

Dimension of the cover plate

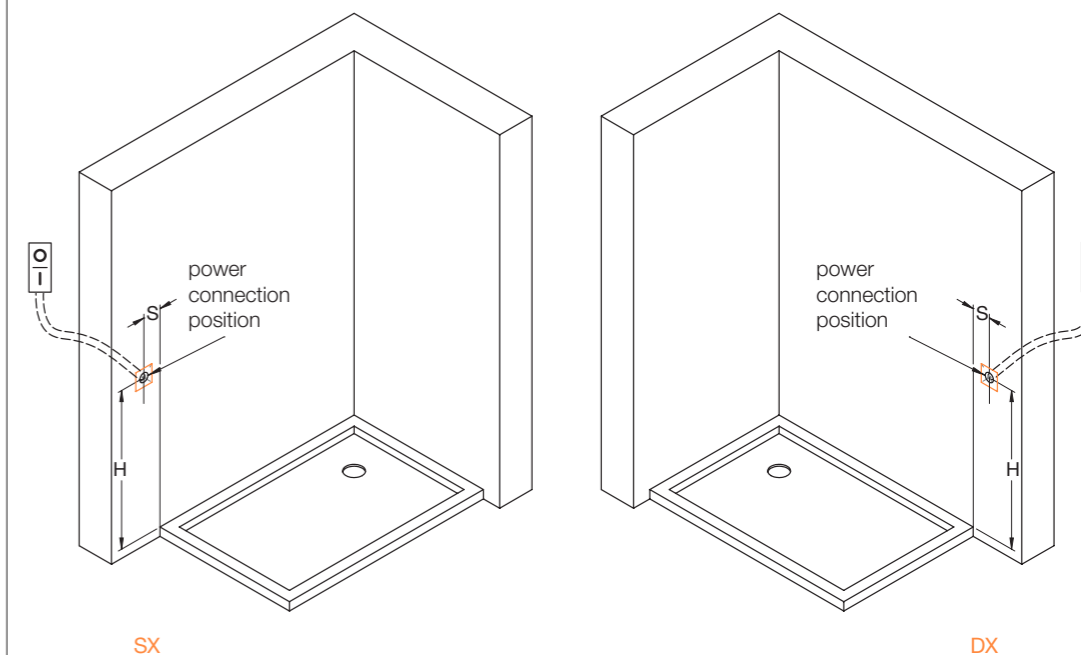
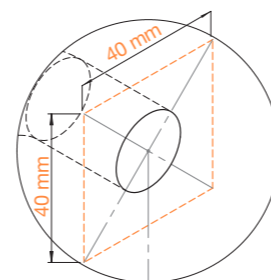

Prepare a corrugated tube in correspondence of the hole and connect its end to a bipolar switch, preferably of a differential type.

The length of the supplied cable is 3 meters.

In case of shower enclosures in non standard height it is necessary to obtain the dimensions S and H concerning the special height.

item	S	H	item	S	H
R-CF / R-CG / R-DF / R-DG R-SK / R-SJ / R-S2	33 mm	1002 mm	R-RF / R-LF	25 mm	967 mm
R-SF / R-SG / R-QF / R-QG	26 mm	980 mm	R-RG / R-LG / R-TWIN	25 mm	978 mm

S = distance from the outer edge of the tray H = height from the top surface of the tray

#### Technical features:

Supply voltage	220-240 V single phase 50 HZ
Power consumption	maximum instantaneous power 1650 W (max 7 A) steady-state : 400/600 W depending on the size of the panel
Pre-heating time	about 10/15 minutes, depending on settings used
Surface temperature	selectable temperatures 56-52-48-44° C

Vismaravetro does not respond in case of the non correct functioning caused by the wrong installation and reserves the right to modify its product at any time without notice.

programme  
gliss - sk-in - serie 8000

\* only with AS20 profile

Radiante  
Heating Panel

- R-DF
- R-DG
- R-SK (l.max cm 98)
- R-SJ (l.max cm 98)
- R-S2
- R-CF
- R-CG

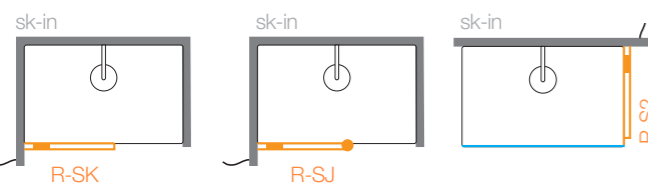
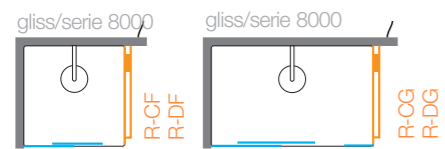
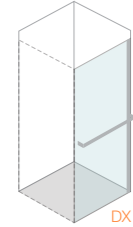
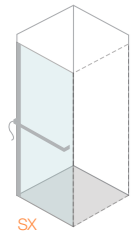
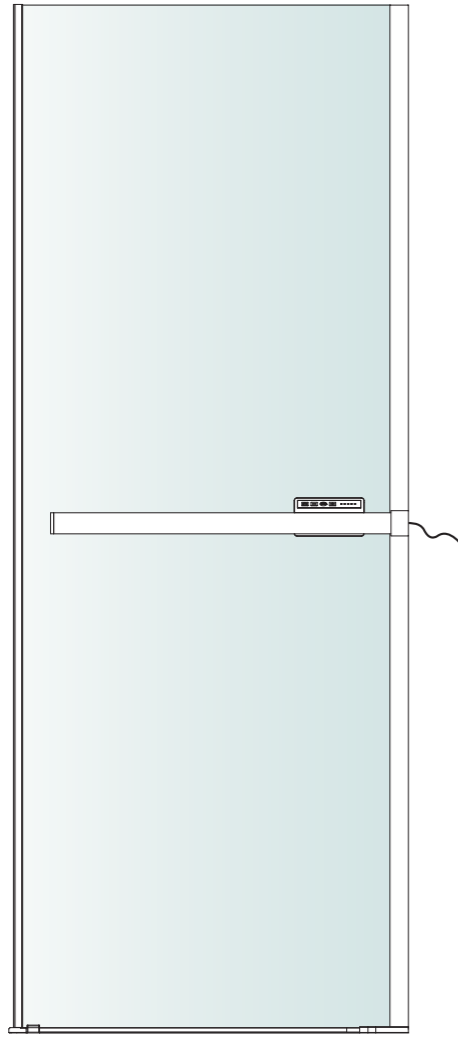

programme  
sintesi - tiquadro

Radiante  
Heating Panel

- R-SF
- R-SG
- R-QF
- R-QG

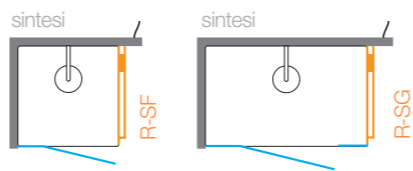
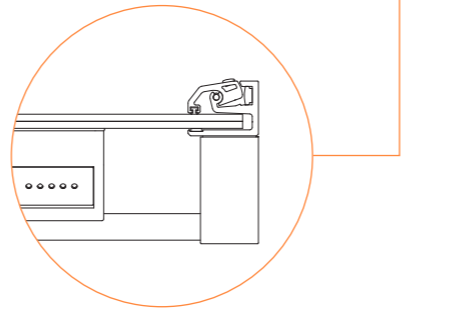
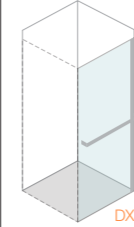
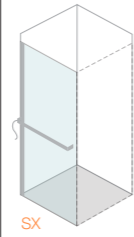
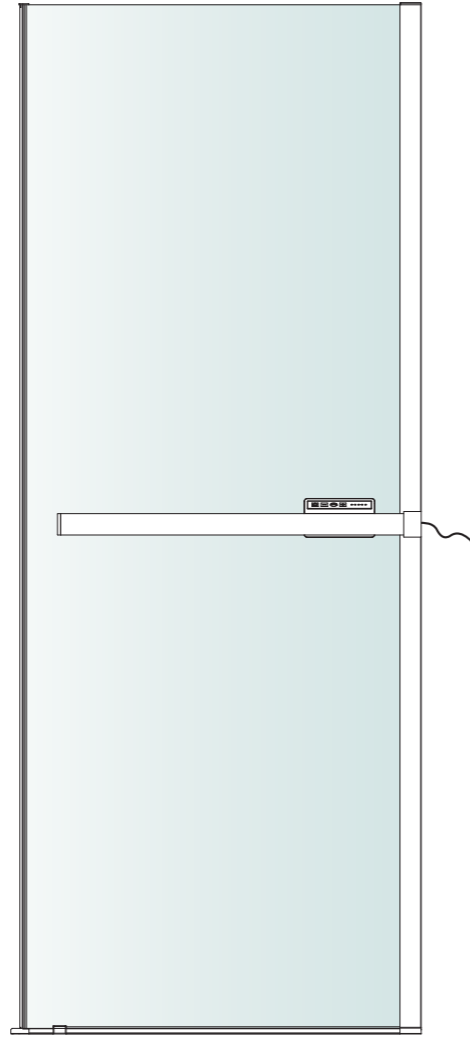

programme  
replay - linea - twin

Radiante  
Heating Panel

- R-RF
- R-RG
- R-LF
- R-LG
- R-TWIN

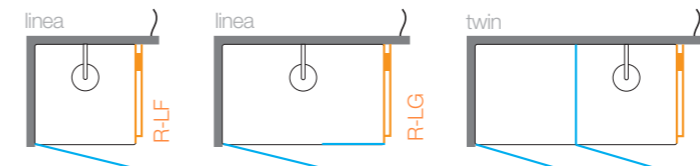
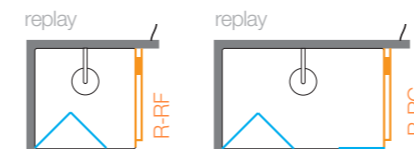
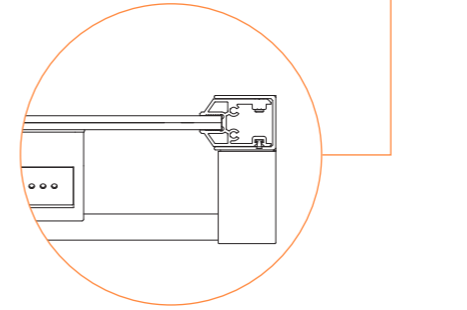
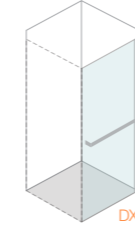
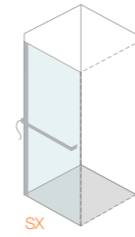
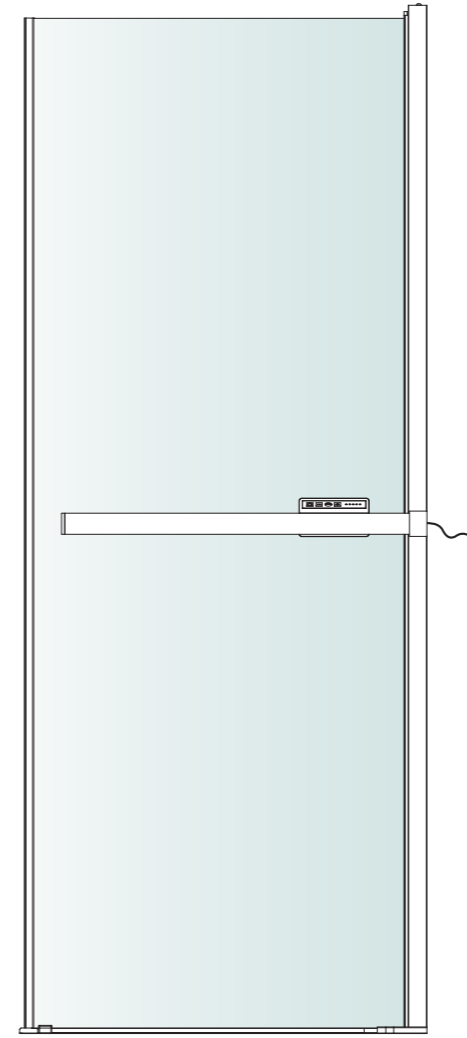

Extra charge for heating version to add to the standard fixed panel price.

dimensions cm	price for 04 clear glass
standard	1.502,00
width L = 78 adjustment 78 - 80	
standard height H = 195 for Sintesi, Replay, Linea, Twin H = 200 for Gliss, SK-in e Serie 8000	
standard	1.557,00
width L = 88 adjustment 88 - 90	
standard height H = 195 for Sintesi, Replay, Linea, Twin H = 200 for Gliss, SK-in e Serie 8000	
MADE TO MEASURE	1.666,00
width L = 78÷87 adjustment 2 cm	
standard height H = 195 for Sintesi, Replay, Linea, Twin H = 200 for Gliss, SK-in e Serie 8000	
MADE TO MEASURE	1.727,00
width L = 88÷98 adjustment 2 cm	
standard height H = 195 for Sintesi, Replay, Linea, Twin H = 200 for Gliss, SK-in e Serie 8000	

Special heights

Special height (min cm. 185 - max cm. 200):  
+ 20% on made to measure price

# complements

In order to meet with the well-being expectations, Vismaravetro dedicates a special selection of accessories to personalize the shower area.



- virgola
- maintenance products
- towel holder
- separating panel
- equipped columns
- brackets
- hardening rods
- special fittings
- profiles
- spare parts
- installations
- layout for measures

# virgola

## Product description

Accessory for glass cleaning with ergonomic handle.



## Technical specifications

Virgola is supplied with shower enclosures having treatment preventing limescale and its price is already included in TPA extra charge for each model.

**Packing: single unit or box of 10 units (can be different finishes)**

Virgola makes the glass cleaning and maintenance easy. It is used without detergents because its shape leaves no water residuals and glass remains clean and shiny. It's ergonomic, practical, always handy, thanks to its magnetic support that can be fitted anywhere.

## How to use Virgola to obtain shiny glass surfaces

- after showering, dry all wet glass surfaces with Virgola
- if necessary use a mild detergent, (e.g. lemon or vinegar based)
- following these simple instructions will prevent water to dry on the glass surface and leave limestone deposits
- if these deposits are not removed they will become very hard to eliminate in time: but with Virgola, glass surfaces will be shiny.

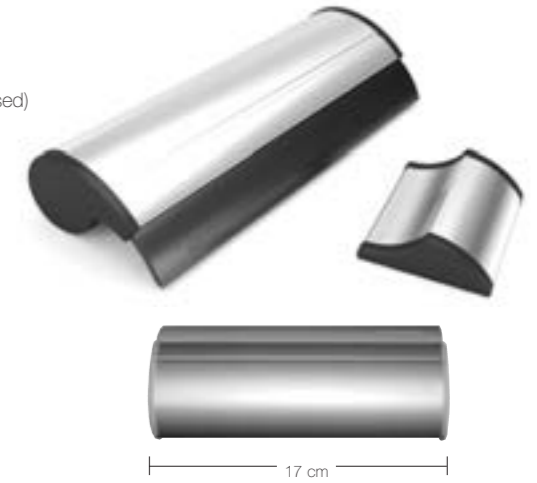

virgola	white 14	satin silver 31	bright silver 21	mat black 09	brushed steel fin. 61	bright gold 23
unit price	56,00	56,00	56,00	61,00	61,00	61,00
unit price in box of 10 units	48,00	48,00	48,00	52,00	52,00	52,00

# maintenance products

## Product description

### Limescale cleansing

This is a product for the everyday cleaning of the shower enclosure, with efficient anti limescale action. It is compatible with T.P.A.

### Maintenance kit

Treatment for the periodic maintenance of T.P.A. This renovates the original T.P.A. for lasting protection against the effects of limescale.



Limescale cleansing

Maintenance kit

unit price	46,00			77,00		
------------	-------	--	--	-------	--	--

**Product description**

Shower trays in composite material

**Materials**

Shower trays in composite material obtained by mixing 75% mineral materials with 25% high-quality resin. The surface coating is coloured throughout its mass, and its matt effect, combined with its finish, make it non-slip. Available in 4 colors and 2 different surface finishes

**Technical specifications**

Inspectional siphon-drain included.

A steel grill is placed as drain cover.

Height h. 3 cm

Basin's dimensions change according to shower tray's dimension



**shower trays**  
**vi.p**

	dimensions cm X x Y	weight	basin dimensioni cm L x P	colours: finishing:
<b>M0709R</b>	70x90	23,5 kg	60x60	14 White - 11 Grey - 09 Black - 10 Dove grey FL smooth - FP stone
<b>M0710R</b>	70x100	27,5 kg	60x60	
<b>M0712R</b>	70x120	35,0 kg	60x60	
<b>M0714R</b>	70x140	40,5 kg	60x130	
<b>M0716R</b>	70x160	47,0 kg	60x130	
<b>M0808R</b>	80x80 square	24,5 kg	70x70	
<b>M0810R</b>	80x100	31,0 kg	70x70	
<b>M0812R</b>	80x120	38,0 kg	70x70	
<b>M0814R</b>	80x140	44,0 kg	70x130	
<b>M0816R</b>	80x160	50,0 kg	70x130	
<b>M0816T</b>	80x160	50,0 kg	70x70	suitable with Twin T1
<b>M8018R</b>	80x180	55,5 kg	70x130	
<b>M8018T</b>	80x180	55,5 kg	70x70	suitable with Twin T1
<b>M0909R</b>	90x90 square	29,0 kg	80x80	
<b>M0912R</b>	90x120	42,0 kg	80x80	
<b>M0914R</b>	90x140	49,0 kg	80x130	
<b>M0916R</b>	90x160	57,0 kg	80x130	
<b>M0981R</b>	90x180	66,0 kg	80x130	
<b>M1010R</b>	100x100	41,0 kg	90x90	only FP stone
<b>M1014R</b>	100x140	50,0 kg	90x130	only FP stone
<b>M1016R</b>	100x160	62,0 kg	90x150	only FP stone

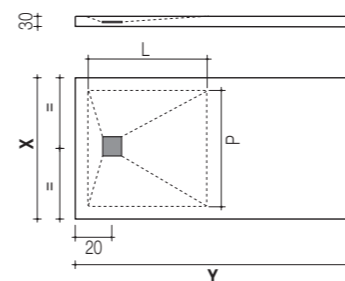

Quick delivery items  
only in versions 14 White - FL smooth

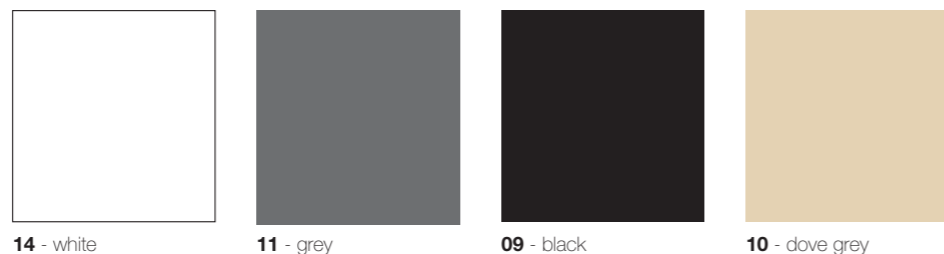

14 - white

11 - grey

09 - black

10 - dove grey

**shower tray with central drain**  
**vi.p**

	dimensions cm X x Y	weight	basin dimensioni cm L x P	colours: finishing:
<b>M0918C</b>	90x180 central drain	66,0 kg	150x70	14 White - 11 Grey - 09 Black - 10 Dove grey FL smooth - FP stone
<b>M0920C</b>	90x200 central drain	73,5 kg	150x70	
<b>M0922C</b>	90x220 central drain	81,0 kg	150x70	

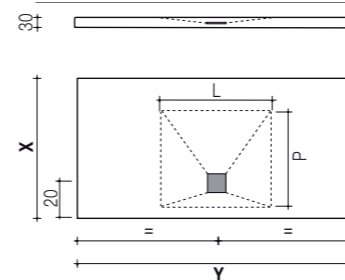

FL - smooth finish

FP - stone finish

**round shower tray R. 55 cm**  
**vi.p**

	dimensions cm X x Y	weight	colours: finishing:
<b>M0808T</b>	80x80 round R.55 cm	22,0 kg	14 White - 11 Grey - 09 Black - 10 Dove grey FL smooth - FP stone
<b>M0909T</b>	90x90 round R.55 cm	28,5 kg	
<b>M1010T</b>	100x100 round R.55 cm	39,2 kg	

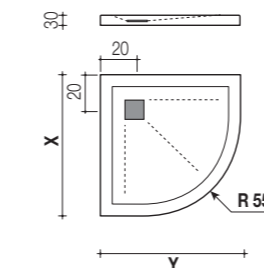

**ATTENTION:** The technical sheets of Vi.p shower trays are available on our webpage [www.vismaravetro.it](http://www.vismaravetro.it) or on request to our technical department.

Quick delivery items  
only in versions 14 White - FL smooth

# towel holder towel holder PST

## Product description

External towel holder.

Can be used on all fixed elements made of 8mm tempered glass.  
The element is fixed to the glass by two through screws and anchored to two interior supports.  
The towel holder is positioned centred horizontally to the wall, if not requested otherwise.



External size 76 mm



towel holder PST	dimension 50 cm	dimension 60 cm 80 cm	dimension 100 cm 120 cm
21 bright silver	229,00	235,00	251,00
09 matt black 15 matt white 31 satin silver 61 brushed steel fin.	251,00	262,00	274,00
32 satin bronze 38 moka 39 metal gun 84 bond copper	262,00	273,00	286,00
23 bright gold	435,00	460,00	485,00

other finishing: on demand

# towel holder PSR

## Product description

External towel holder

Can be used on all fixed elements made of 8mm tempered glass.  
The element is fixed to the glass by two flush screws: the inner surface is free from obstructions.  
The towel holder is positioned centred horizontally to the wall, if not requested otherwise.



External size 90 mm



towel holder PSR	dimension 50 cm	dimension 60 cm 80 cm	dimension 100 cm 120 cm
21 bright silver	144,00	153,00	168,00
09 matt black 15 matt white 31 satin silver 61 brushed steel fin.	148,00	157,00	172,00
32 satin bronze 38 moka 39 metal gun 84 bond copper	157,00	172,00	180,00
23 bright gold	168,00	183,00	189,00

other finishing: on demand

# separating panel

## Product description

Screen is a sliding panel made of tempered glass, as a room inside the shower area.

It is equipped with 3 shelves on one side and 2 hooks for towels and bathrobes on the other. When showering, Screen protects the bathrobe while shelves can be used for objects.

After the shower, the bathrobe is quite easy to take so to get dried in comfort and pleasant temperature.

## Technical characteristics

It can be fitted on most shower enclosures.

For frameless shower enclosures it is suitable for 6 mm and 8 mm thickness glass.

Equipped with two towels' hook

Depth 25 cm.

Reversible.

## Materials

Safety tempered glass  
Sliding panel 6 mm  
Central panel 8 mm  
Shelves 10 mm

Anodised aluminium profiles

# screen

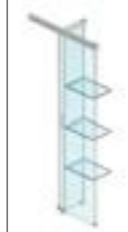

article

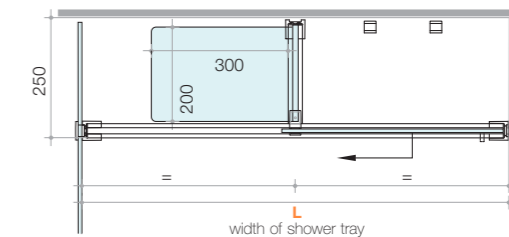

dimension L

SCREEN 70  
SCREEN 80  
SCREEN 90

69÷76  
76÷83  
83÷90

## separating panel

h. 160 cm

codes	profiles	sliding panel glass			
		04 clear glass	08 satin glass	10 extra-reflex 14 satin extra-light 19 madras pavè	04 clear glass with decoration D61
SCREEN 70	31 satin silver	1.084,00	1.273,00	1.364,00	1.245,00
SCREEN 80	21 bright silver	1.141,00	1.330,00	1.420,00	1.304,00
SCREEN 90					

**Product description**

Complementary column for corner shower enclosures

**Characteristics**

Double aluminium profile having a groove to position some accessories at various levels.

Anodized or enamelled aluminum profile

Tempered satin glass shelves on sliding fixing bracket.

Hanging hook

Handle (chromed)

Foot rest (chromed)

All accessories can be placed at changeable positions.

amico



amico junior



equipped columns h. 195 cm	amico 2 shelves code <b>BAM2</b>	amico 3 shelves code <b>BAM3</b>
enamelled white	744,00	845,00
satin silver	763,00	864,00
enamelled colours bright silver	781,00	882,00
bright gold	894,00	995,00

equipped columns h. 90 cm	amico JR 2 shelves code <b>BAJ2</b>	amico JR 3 shelves code <b>BAJ3</b>
enamelled white	352,00	453,00
satin silver	363,00	464,00
enamelled colours bright silver	373,00	474,00
bright gold	447,00	548,00

**Options**

Additional shelf in satin glass **MA:**

101,00

Hook **GA:**

21,00

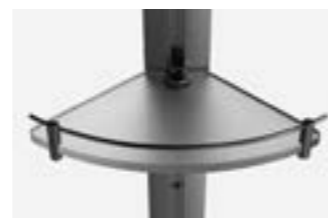

**Product description**

Equipped columns for shower enclosure.

**Characteristics**

Corner element made of double stainless steel double profile with possibility to position some accessories at various level.

Available in 2 versions: against wall or in corner.

The wall version can be installed against wall or glass.

Shelves made of tempered clear glass complete with fixing holder frame.

Hanging hook.

The shelves can be set at desired height.

Stainless steel, bright finish.

wall solution



equipped columns h. 85 cm	basket 2 shelves code <b>BKP221</b>	basket 3 shelves code <b>BKP321</b>
bright stainless steel	466,00	594,00

corner solution



equipped columns h. 85 cm	basket 2 shelves code <b>BKA221</b>	basket 3 shelves code <b>BKA321</b>
bright stainless steel	493,00	621,00

**Options**

Additional shelf in clear glass **MA:**

128,00

Please specify if the requested shelf is right **DX** or left **SX**



# corner fixing brackets

## Product description

Adjustable corner fixing bracket.

### Fixing bracket "P"

Used for the programme Supersintesi

### Fixing bracket "Q"

Suitable for all the programmes with frameless fixed panels made of 8 mm glass.

### Fixing bracket "Q - G"

"Q" fixing bracket customized to be suitable with Junior and Serie 7200 programmes.

### Fixing bracket "Z"

Bracket suitable only for Link programme.



bracket P

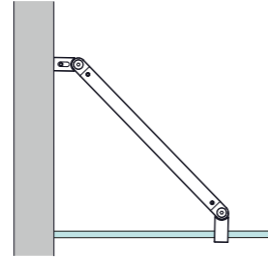

bracket Q - G

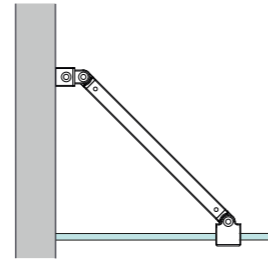

bracket Z

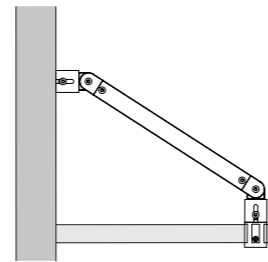

## Technical specifications

On request it is possible to use the brackets "P" or "Q" to harden two glass panels.

14 white	31 satin silver	21 bright silver	09 matt black	23 bright gold	34 matt copper
			39 metal gun	32 satin bronze	35 matt gold
			61 brushed steel fin.	33 satin gold	54 brushed copper
				38 moka	
				52 brushed bronze	
				72 dark bronze	
				84 bond copper	

items	dimensions min - max	14 white	31 satin silver	21 bright silver	09 matt black	23 bright gold	34 matt copper
P 20	15 cm - 25 cm	74,00	88,00	94,00	114,00	130,00	216,00
P 30	20 cm - 35 cm	74,00	88,00	94,00	114,00	130,00	216,00
P 40	25 cm - 45 cm	74,00	88,00	94,00	114,00	130,00	216,00
Q 20 - G 20	15 cm - 25 cm	74,00	88,00	94,00	114,00	130,00	216,00
Q 30 - G 30	20 cm - 35 cm	74,00	88,00	94,00	114,00	130,00	216,00
Q 40 - G 40	25 cm - 45 cm	74,00	88,00	94,00	114,00	130,00	216,00
Q 50 - G 50	30 cm - 55 cm	74,00	88,00	94,00	114,00	130,00	216,00
Z 20	15 cm - 25 cm	131,00	120,00	120,00	131,00	138,00	226,00
Z 30	20 cm - 35 cm	131,00	120,00	120,00	131,00	138,00	226,00
Z 40	25 cm - 45 cm	131,00	120,00	120,00	131,00	138,00	226,00

# straight stabiliser rods

## Product description

Adjustable straight stabiliser rod.

## Characteristics

If necessary, the stabiliser rod can be cut at wall side.

### Stabiliser rod "K - T"

Supplied for Sk-in programme. For combinations SK+SZ and SB+SZ we suggest to install the stabiliser rods K and T to strengthen SZ stability.

### Stabiliser rod "R - J"

Supplied for Sk-in, Flare, Sintesi and Linea programmes. Suitable for all the programmes with frameless fixed panels made of 8 mm glass.

### Stabiliser rod "PKR"

"R" stabilizer rod customized to be suitable with Frame programme.

### Stabiliser rod "P"

Supplied for Supersintesi programme.

### Stabiliser rod "Z"

Rod suitable only for Link programme.



rod K



rod K + T



rod R



rod R + J



rod P



rod P + J



rod Z

14 white	31 satin silver	21 bright silver	09 matt black	23 bright gold	34 matt copper
			39 metal gun	32 satin bronze	35 matt gold
			61 brushed steel fin.	33 satin gold	54 brushed copper
				38 moka	
				52 brushed bronze	
				72 dark bronze	
				84 bond copper	

items	dimension max	14 white	31 satin silver	21 bright silver	09 matt black	23 bright gold	34 matt copper
R 100	100 cm	82,00	95,00	101,00	124,00	141,00	275,00
R 120	120 cm	82,00	95,00	101,00	124,00	141,00	275,00
J 15	15 cm	70,00	75,00	82,00	101,00	118,00	189,00
K 100	100 cm	138,00	157,00	172,00	209,00	229,00	329,00
K 120	120 cm	138,00	157,00	172,00	209,00	229,00	329,00
K 160	160 cm	179,00	198,00	214,00	259,00	229,00	415,00
T 15	15 cm	104,00	122,00	132,00	160,00	176,00	294,00
T 70	70 cm	125,00	140,00	157,00	188,00	208,00	310,00
P 100	100 cm	82,00	95,00	101,00	124,00	141,00	275,00
P 120	120 cm	82,00	95,00	101,00	124,00	141,00	275,00
Z 100	100 cm	121,00	99,00	99,00	121,00	138,00	269,00
Z 120	120 cm	121,00	99,00	99,00	121,00	138,00	269,00

# special fittings

**type 1**  
Lateral fitting for aligned shower tray  
**Frame** PKT - PKF  
**Link** all models  
**Supersintesi** all models  
**Flare** FF - F2 (fixed panel)  
**Serie F** H2 (fixed panel)  
**Gliss** all models  
**Sk-in** SK - SJ - S2  
**Linea** all models  
**Sintesi** SN - SM - SA - SF - SG  
**Replay** all models  
**Serie 8000** all models  
**Junior** all models  
**Serie 7200** all models  
**Bathscreens** SV - NP - BN - B4 - LV

**type 2**  
Lateral fitting for built-in shower tray  
**Frame** PKT - PKF  
**Link** all models  
**Supersintesi** all models  
**Flare** FF - F2 (fixed panel)  
**Serie F** H2 (fixed panel)  
**Gliss** all models  
**Sk-in** SK - SJ - S2  
**Linea** all models  
**Sintesi** SN - SM - SA - SF - SG  
**Replay** all models  
**Serie 8000** all models  
**Junior** all models  
**Serie 7200** all models  
**Bathscreens** SV - NP - BN - B4 - LV

**type 3**  
Lateral fitting for 'narrow' shower tray  
**Frame** PKT - PKF  
**Link** all models  
**Supersintesi** all models  
**Flare** FF - F2 (fixed panel)  
**Serie F** H2 (fixed panel)  
**Gliss** all models  
**Sk-in** SK - SJ - S2  
**Linea** all models  
**Sintesi** SN - SM - SA - SF - SG  
**Replay** all models  
**Serie 8000** all models  
**Junior** all models  
**Serie 7200** all models  
**Bathscreens** SV - NP - BN - B4 - LV

**type 4**  
Special fitting for oblique walls.  
**Frame** PKT - PKF  
**Link** all models  
**Supersintesi** all models  
**Flare** FF - F2 (fixed panel)  
**Gliss** all models  
**Sk-in** SK - SJ - S2  
**Linea** all models  
**Sintesi** SN - SM - SA - SF - SG  
**Replay** RN - RA  
**Serie 8000** all models  
**Junior** all models  
**Serie 7200** all models  
**Bathscreens** SV - NP - BN - B4 - LV

**type 5**  
Special fitting for standing out shower trays.  
**Frame** PKT - PKF  
**Link** all models  
**Supersintesi** all models  
**Flare** FF - F2 (fixed panel)  
**Serie F** H2 (fixed panel)  
**Gliss** all models  
**Sk-in** SK - SJ - S2  
**Linea** all models  
**Sintesi** SN - SM - SA - SF - SG  
**Replay** all models  
**Serie 8000** all models  
**Junior** all models  
**Serie 7200** all models  
**Bathscreens** SV - NP - BN - B4 - LV

Prices for profiles with a maximum height of 225 cm  
For higher heights, surcharge + 50%.

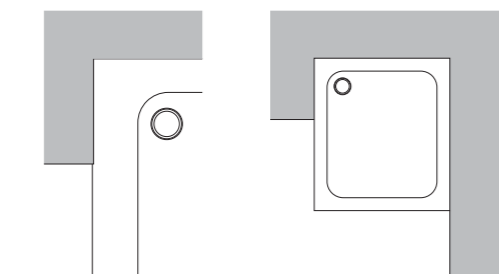

Only for walls aligned to the outer part of the shower tray

The below solutions and relevant prices refer to the most common situations.  
For complex requirements involving special executions, we suggest to require a quotation in advance.

14 white 31 satin silver	21 bright silver	09 matt black 39 metal gun 61 brushed steel fin.
173,00	201,00	223,00
		Other finishing on request

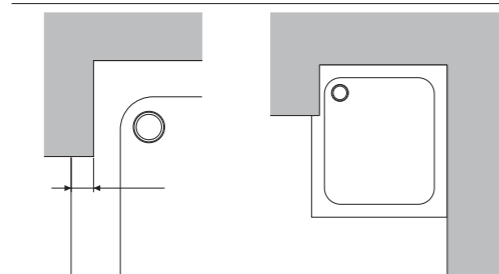

Please always advise the overlap's dimension in mm

14 white 31 satin silver	21 bright silver	09 matt black 39 metal gun 61 brushed steel fin.
185,00	216,00	239,00
		Other finishing on request

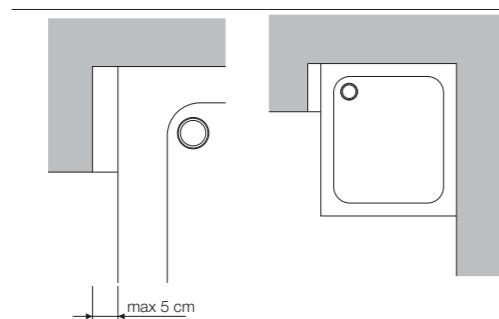

Please always advise the dimension in mm

14 white 31 satin silver	21 bright silver	09 matt black 39 metal gun 61 brushed steel fin.
245,00	274,00	301,00
		Other finishing on request

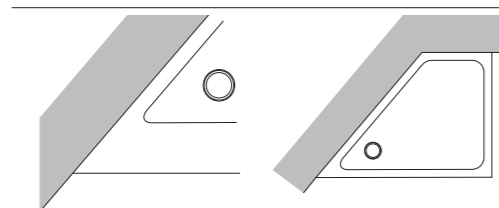

Please always advise angle's dimension

14 white 31 satin silver	21 bright silver	09 matt black 39 metal gun 61 brushed steel fin.
185,00	216,00	239,00
		Other finishing on request

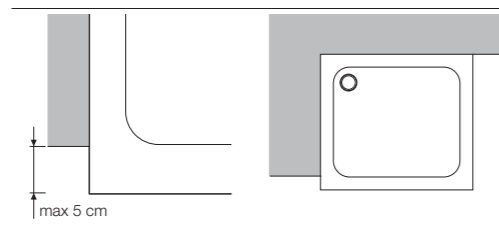

Please always advise the dimension in mm

14 white 31 satin silver	21 bright silver	09 matt black 39 metal gun 61 brushed steel fin.
173,00	201,00	223,00
		Other finishing on request

# profiles

Prices for profiles with a maximum height of 225 cm  
For higher heights, surcharge + 50%.

## AS10

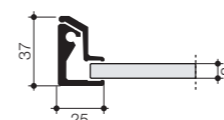

dimensions  
axbxc  
wall profile for **Gliss** and **Serie 8000**  
h = 199 cm  
Suitable for SK with standard height

14 white 31 satin silver	21 bright silver	09 matt black 39 metal gun 61 brushed steel fin.	23 bright gold 32 satin bronze 38 moka 05±15 colored 84 bond copper
216,00	232,00	256,00	291,00

## Corner square profiles

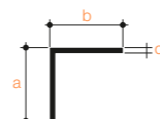

QAZ11L	10x10x2	75,00	78,00	85,00	97,00
QAZ15L	15x15x2	75,00	78,00	85,00	97,00
QAZ22L	20x20x2	78,00	85,00	94,00	105,00
QAZ25L	25x25x2	82,00	88,00	97,00	111,00
QAZ33L	30x30x2	88,00	91,00	101,00	117,00
QAZ35L	35x35x2	90,00	95,00	104,00	120,00
QAZ44L	40x40x2	95,00	100,00	111,00	127,00
QAZ45L	45x45x2	99,00	104,00	117,00	130,00
QAZ55L	50x50x2	101,00	110,00	120,00	138,00

## Corner rectangular profiles

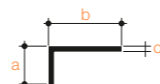

QAZ13L	10x30x2	78,00	85,00	94,00	105,00
QAZ14L	10x40x2	82,00	88,00	97,00	111,00
QAZ54L	15x40x2	85,00	89,00	99,00	114,00
QAZ24L	20x40x2	87,00	90,00	100,00	115,00
QAZ27L	25x50x2	91,00	99,00	110,00	124,00

## Tube squared profiles

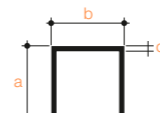

QAZ44T	40x40x2	127,00	133,00	147,00	168,00

## Tube rectangular profiles

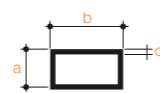

QAZ15T	15x40x2	103,00	114,00	124,00	141,00
QAZ24T	20x40x2	110,00	119,00	130,00	148,00
QAZ36T	30x60x2	133,00	141,00	155,00	176,00

## "U" profiles

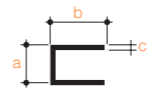

QAZ10U	10x15x1,5	88,00	90,00	100,00	115,00
QAZ12U	12x15x1,5	94,00	97,00	105,00	122,00

## Rectangular rods



QAZ010P	10x2	67,00	71,00	78,00	88,00
QAZ020P	20x2	69,00	72,00	80,00	89,00
QAZ050P	50x2	85,00	89,00	99,00	114,00
QAZ080P	80x2	95,00	100,00	111,00	127,00
QAZ100P	100x3	125,00	130,00	144,00	165,00
QAZ036P	35x6	103,00	114,00	124,00	141,00
QAZ081P	15x8	85,00	88,00	97,00	111,00
QAZ038P	35x8	122,00	128,00	140,00	160,00

## Additional profile AD15

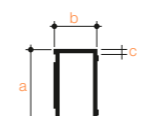

QAD15	25x15x2,2	78,00	78,00	91,00	105,00

Other finishing on request

spare parts SEALS

Price  
(not including transport)

	spare part's code:	description:	suitable for:	
	<b>MAB1700</b>	magnetic ALIBI	Linea, Alibi	33,61
	<b>MAB2000</b>	dripstone ALIBI - cm. 100	Alibi	42,62
	<b>MAB2100</b>	dripstone ALIBI quadrant - (pair)		62,30
	<b>MAL1300</b>	dripstone ALA - cm. 130	Bathscreens	52,46
	<b>MFL40500</b>	dripstone door FLARE - cm. 100	Flare, SerieF	31,97
	<b>MND40300</b>	dripstone with ledge GA 2014	Junior	35,25
	<b>MND40600</b>	balloon gasket JUNIOR 2014	Junior	35,25
	<b>MND40700</b>	vertical oblique dripstone GN 2014	Junior	35,25
	<b>MND40800</b>	rail gasket GN - cm. 100	Junior	27,87
	<b>MND40900</b>	magnetic 180° JUNIOR GA 2014	Junior	40,98
	<b>MNJ01400</b>	vertical central fin JUNIOR 2015	Junior	36,89
	<b>MNJ40200</b>	magnetic GA GN G2 2015	Junior	35,25
	<b>MNJ40300</b>	magnetic rising GA GN 2015	Junior	45,90
	<b>MNJ40400</b>	magnetic fin rising GA GN 2015	Junior	35,25
	<b>MRP40100</b>	dripstone LINEA-REPLAY-JUNIOR - cm. 100	Linea, Twin, Replay, Junior.	26,23
	<b>MRP401T00</b>	dripstone quadrant LINEA LT - (pair)		53,28

For spare parts' codes, please refer to the exploded drawings on the assembly instruction or on our webpage: [www.vismaravetro.it](http://www.vismaravetro.it)

Price  
(not including transport)

	spare part's code:	description:	suitable for:	
	<b>MSC40100</b>	glass fasten for 6000 - 7000 - JUNIOR - 6 meters	Junior, Serie7000, Serie6000	33,61
	<b>MSC40200</b>	slot cover for Serie 6000 - 4 meters	Serie7000, Serie6000	27,87
	<b>MSC40400</b>	vertical FIXED-DOOR 6000	Serie6000	33,61
	<b>MSC40500</b>	45° magnetic 6200 thickness 6mm - (pair)	Sintesi, Serie6000	59,84
	<b>MSC40700</b>	Door closing 6100	Serie6000	45,90
	<b>MSC40900</b>	180° magnetic 6000T 6000D thikness 6mm - (pair)	Sintesi, Serie6000, Serie7000	59,84
	<b>MSC3100</b>	vertical fixed-door 7000	Serie7000	33,61
	<b>MSI0800</b>	dripstone SINTESI 45° glass 6 mm - cm. 70	Sintesi, Serie6000	36,89
	<b>MSI0808</b>	dripstone SINTESI SV SR glass 8 mm - cm. 100		36,89
	<b>MSI0800SL</b>	dripstone SINTESI 45° DX-SX for SL - cm 100		36,89
	<b>MSI0938</b>	CURVED dripstone under door SD	Replay (models up to 2010), Sintesi, Tiquadro, Bathscreens	47,54
	<b>MSI0955</b>	CURVED dripstone under door SX		47,54
	<b>MSI09SR</b>	CURVED dripstone SR		49,18
	<b>MSI11900 /D /S</b>	dripstone NP - (pair) Always inform handing and dimension of original product	Bathscreens	55,74
	<b>MSI1200</b>	balloon gasket fix and door 8 mm glass	Sintesi, Tiquadro, Junior, Bathscreens	37,70
	<b>MSI1201</b>	balloon gasket fix and door 6 mm glass		36,89
	<b>MSI1203</b>	balloon gasket "8PT8" 8mm for SY	Sk-in, SerieF	40,98
	<b>MSI1204</b>	balloon gasket "8PT10" 8 mm for Serie F	SerieF	40,98
	<b>MSI1300</b>	silicone rubber - cm. 100	Linea, Twin, Replay, Sintesi, Tiquadro, Bathscreens, Alibi	21,31

	spare part's code:	description:	suitable for:	
	<b>MSI2100</b>	magnetic SINTESI_LITE SA SN 6 mm	Sintesi, Serie6000	40,98
	<b>MSI2200</b>	magnetic SINTESI_LITE SF 8 mm	Sintesi, Serie8000	47,54
	<b>MSI40300</b>	glass assembly seal - 4 mt	SerieF, Bathscreens	40,98
	<b>MSI8900</b>	magnetic SINTESI - LINEA - REPLAY	Flare, Linea, Twin, Replay, Sintesi, Tiquadro, Alibi	35,25
	<b>MSS40100</b>	glass faster SLIDE GLISS SERIE 8000 - cm. 100	Gliss, Sk-in, Serie8000, Bathscreens	26,23
	<b>MSS40200</b>	vertical FIXED-DOOR	Gliss, Serie8000, Bathscreens	35,25
	<b>MSS40300</b>	magnetic SLIDE GLISS SERIE 8000	Gliss, Serie8000, Bathscreens	31,15
	<b>MSS40500</b>	dripstone door - cm. 100	SerieF, Gliss, Serie8000, Bathscreens	31,15
	<b>MST40700</b>	magnetic 180°	Serie7000	31,15
	<b>MST40900</b>	dripston with double wing for the door - cm. 100	Serie7000	36,89
	<b>MSU402</b>	magnetic 45° 8 mm for Serie 8000	Sintesi, Serie8000	47,54
	<b>MSU403</b>	magnetic 180° 8 mm for Serie 8000	Sintesi, Serie8000	47,54
	<b>MTQ40500</b>	siliconic rubber for FIXED	Flare, Linea, Twin, Replay, Sintesi, Tiquadro, Bathscreens	21,31

You can find and order the replacement part needed by your customer comfortably online.

Managing spare parts is an important service activity but extremely delicate. It is source of possible dissatisfaction for the end user and for the intermediary and often not remunerative. In order to make the spare parts availability service efficient and contextually to lighten the commitment to retail as much as possible, we offer the following opportunities to our customers:

- purchase the spare parts with the current mode in use;
- buy spare parts through the site by entering some data and the photos of the piece to be replaced;
- invite your customer to buy directly through the site.

The choice is yours!



# installations

L: final dimension of the installed shower tray or of the tiled floor

Standard installation

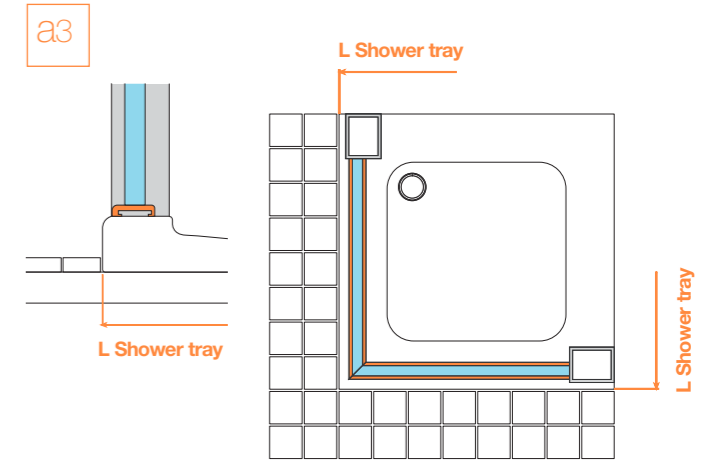
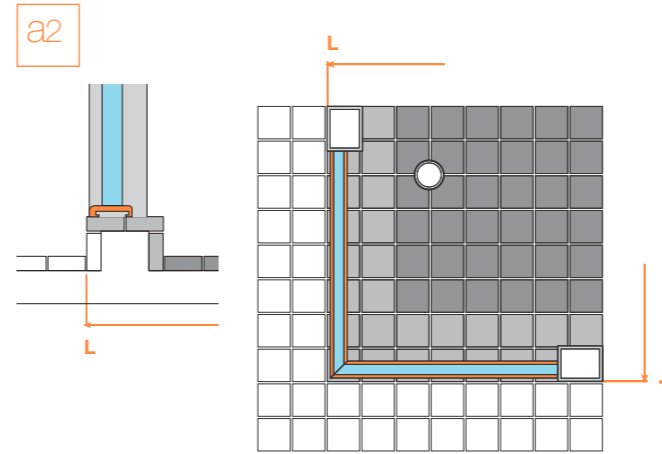
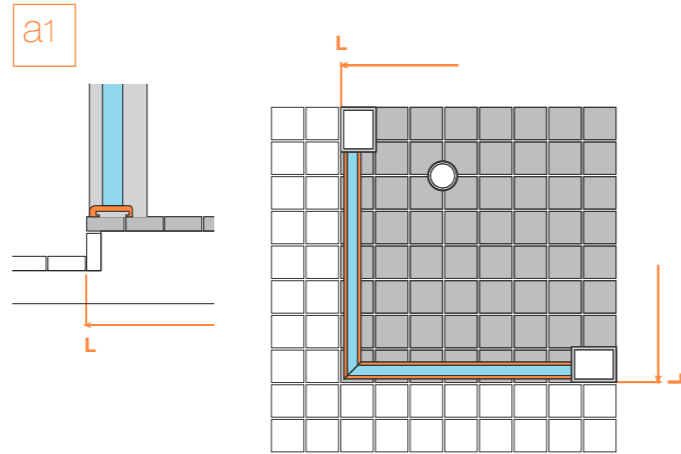
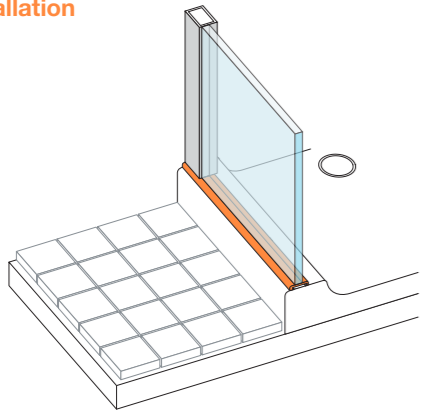

Built in shower tray, floor level

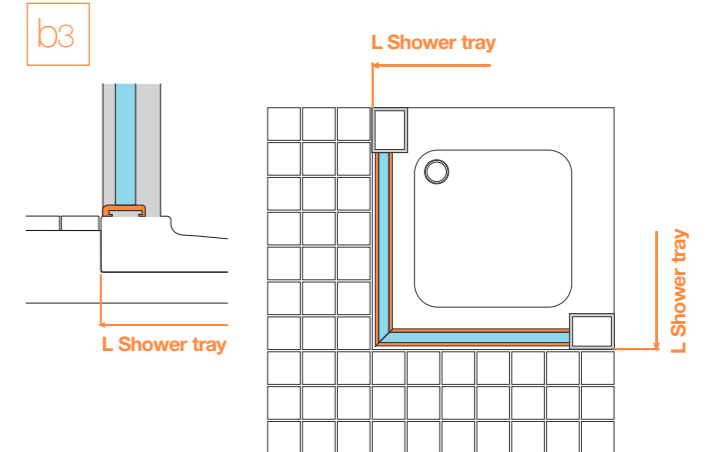
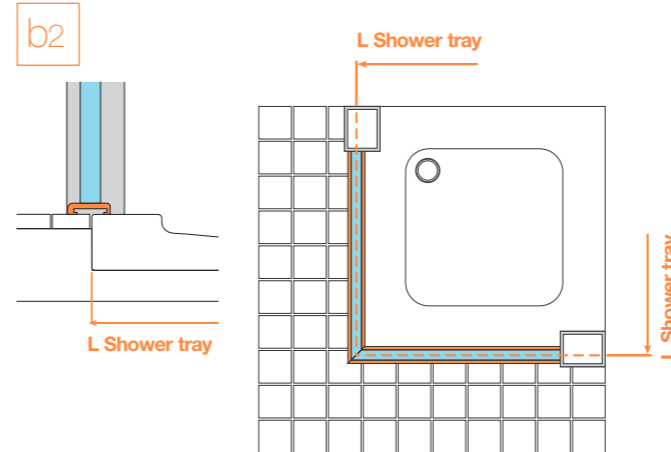
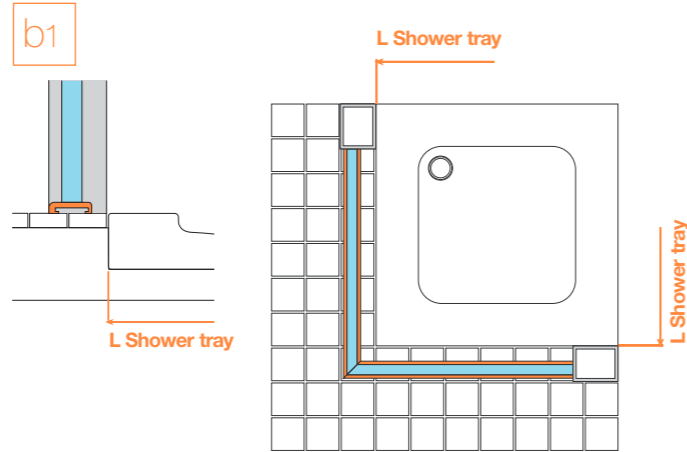
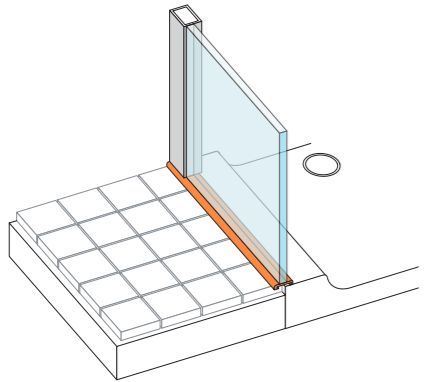

Installation on the floor

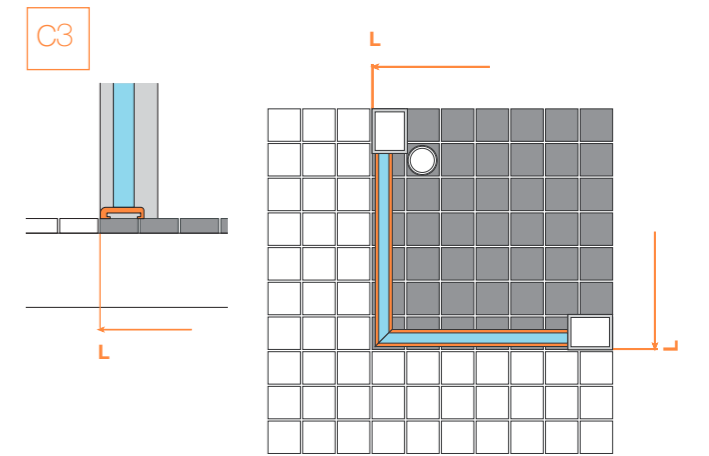
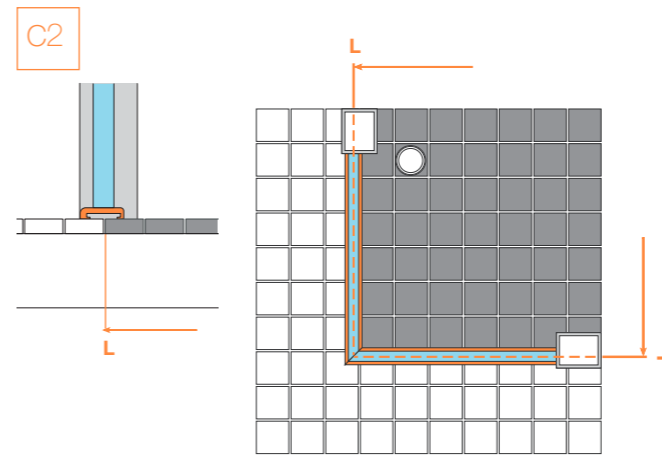
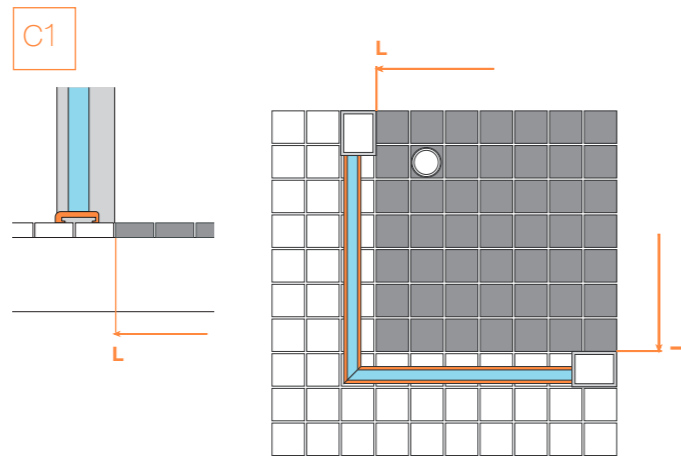
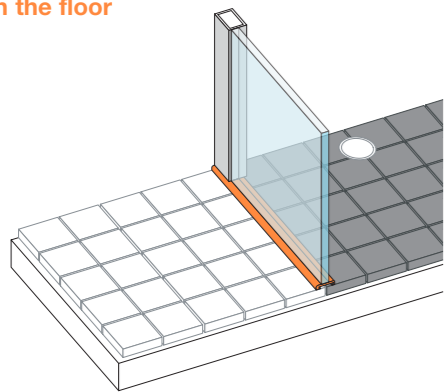

Installation on step

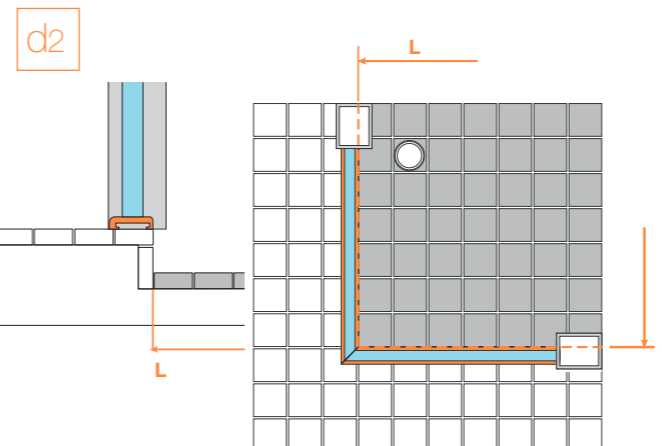
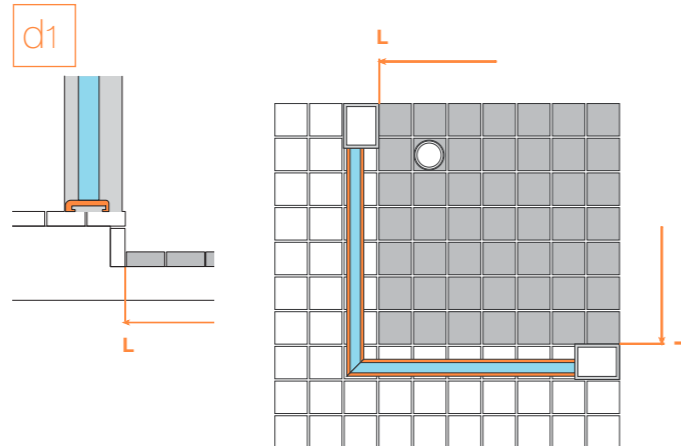
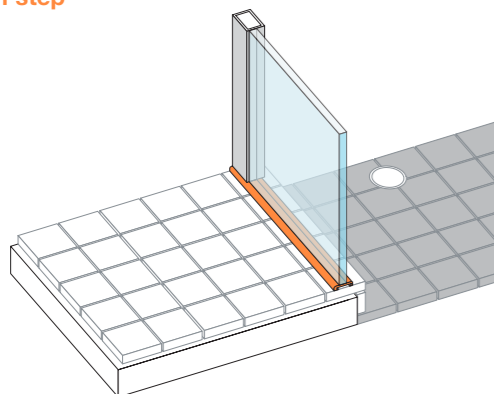

# layouts for measures

All the technical drawings in pdf format are available on the website [www.vismaravetro.it](http://www.vismaravetro.it)

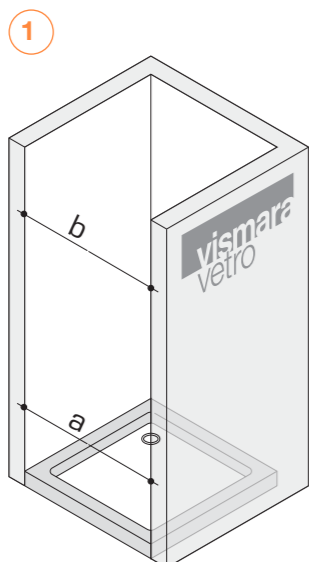

a = mm. \_\_\_\_\_  
b = mm. \_\_\_\_\_

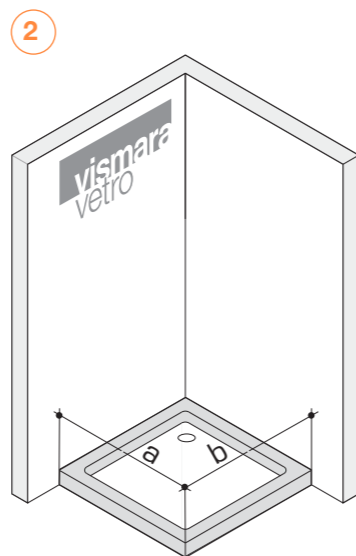

a = mm. \_\_\_\_\_  
b = mm. \_\_\_\_\_

Flare: **FN - F2**  
Serie F: **HL - HN - H2**  
Gliss: **DN - D3 - D4**  
Linea: **LN - LB - L2 - LZ - L3**  
InOut: **IN1 - IF1**  
Replay: **RN - RM**  
Sintesi: **SL - SN - SM**  
Junior: **GN - GA - G2 - GM**  
Serie 8000: **CN - C3 - C4**  
Serie 7200: **ZN**

Flare: **FA+FA - FA+FF - F2+FG**  
Gliss: **DA - DF+DQ - D3+DG - D4+DG**  
Linea: **LA+LA - LA+LF - LB+LG - L2+LG - L3+LG**  
InOut: **IN2 - IF2**  
Replay: **RA+RA - RA+RF - RM+RG**  
Sintesi: **SA+SA - SA+SF - SM+SG**  
Junior: **GN+GF - GA**  
Serie 8000: **CA - CF+CQ - C3+CG - C4+CG**  
Serie 7200: **ZQ+ZF - ZN+ZG - ZA+ZA**

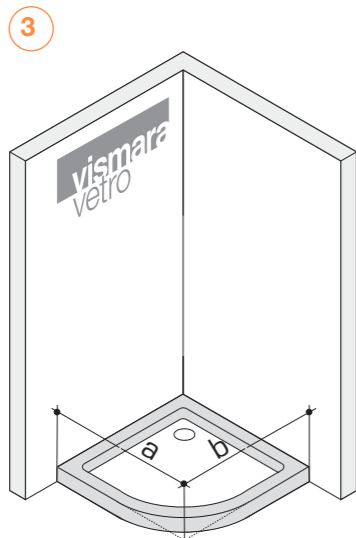

a = mm. \_\_\_\_\_  
b = mm. \_\_\_\_\_

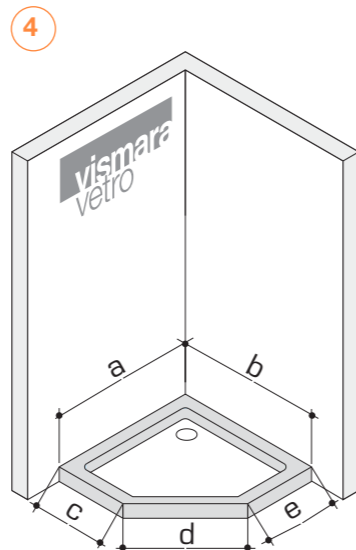

a = mm. \_\_\_\_\_  
b = mm. \_\_\_\_\_  
c = mm. \_\_\_\_\_  
d = mm. \_\_\_\_\_  
e = mm. \_\_\_\_\_

Linea: **LT - LTX**  
Sintesi: **ST - SH - SX - SD**  
Serie 7200: **ZT - ZD**

Sintesi: **TRS**

Customer

Town

Phone

ref.

model

glass finish

profiles finish

opening  sx  dx

Vismaravetro Srl  
20843 Verano Brianza (MB) - Italy  
Via Furlanelli, 29  
phone: +39 0362 992244  
e-mail: [info@vismaravetro.it](mailto:info@vismaravetro.it)  
[www.vismaravetro.it](http://www.vismaravetro.it)

# layouts for measures

All the technical drawings in pdf format are available on the website [www.vismaravetro.it](http://www.vismaravetro.it)

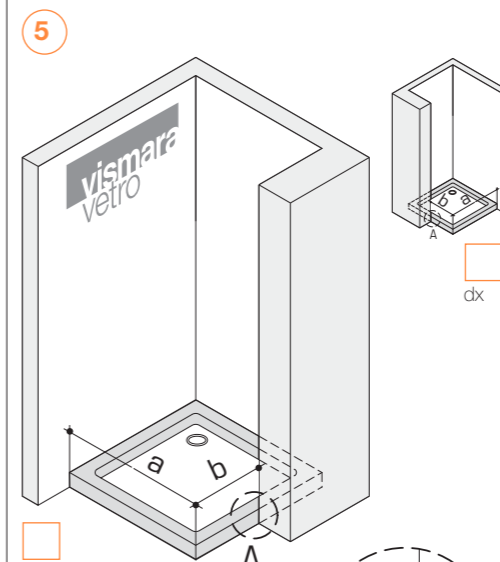

a = mm. \_\_\_\_\_  
b = mm. \_\_\_\_\_

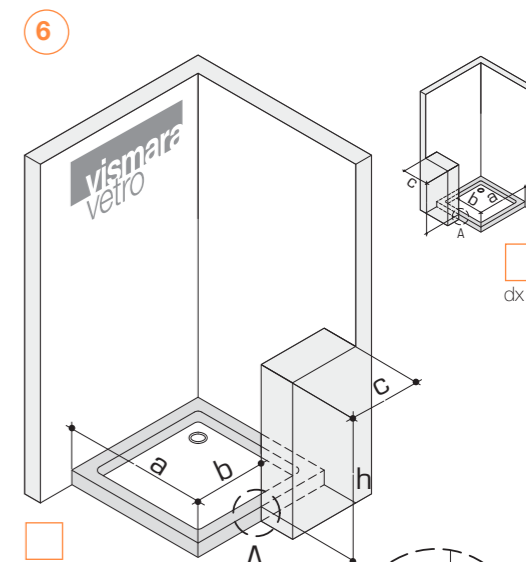

a = mm. \_\_\_\_\_  
b = mm. \_\_\_\_\_  
c = mm. \_\_\_\_\_  
h = mm. \_\_\_\_\_

Gliss: **DQ+DF**  
Linea: **LA+LF - LB+LG - L2+LG - L3+LG**  
Replay: **RA+RF - RM+RG**  
Sintesi: **SA+SF - SM+SG**  
Junior: **GN+GF - GA+GF**  
Serie 8000: **CQ+CF**  
Serie 7200: **ZQ+ZF - ZN+ZG**

The feasibility and the choice of the programme depends on real measured size: it is recommended to request a quotation.

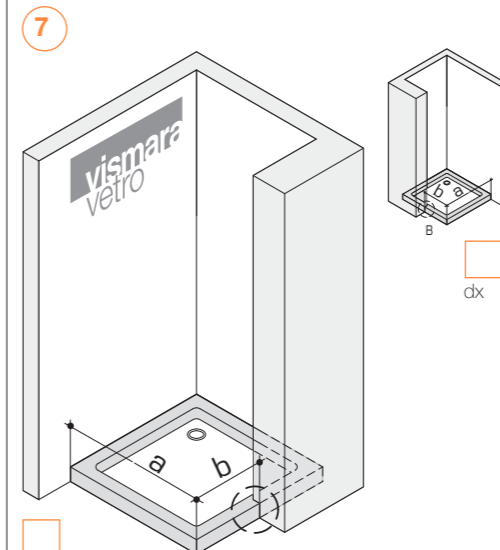

a = mm. \_\_\_\_\_  
b = mm. \_\_\_\_\_  
c = mm. \_\_\_\_\_

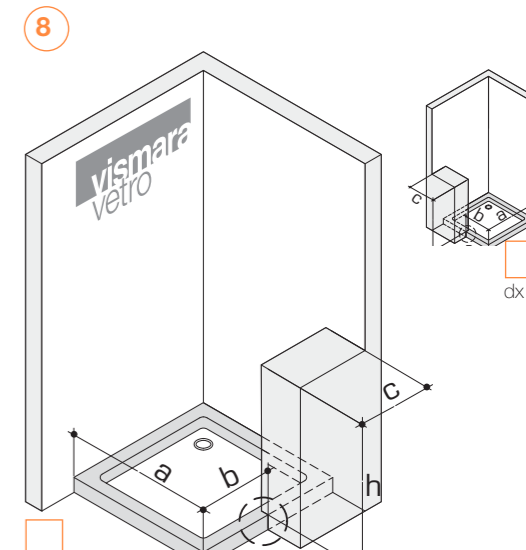

a = mm. \_\_\_\_\_  
b = mm. \_\_\_\_\_  
c = mm. \_\_\_\_\_  
d = mm. \_\_\_\_\_  
h = mm. \_\_\_\_\_

Gliss: **DQ+DF - D3+DG**  
Linea: **LA+LA - LA+LF - LB+LG - L2+LG - L3+LG**  
Replay: **RA+RF - RM+RG**  
Sintesi: **SA+SF - SM+SG**  
Junior: **GN+GF - GA+GF**  
Serie 8000: **CQ+CF - C3+CG**  
Serie 7200: **ZQ+ZF - ZN+ZG**

The feasibility and the choice of the programme depends on real measured size: it is recommended to request a quotation.

Customer

Town

Phone

ref.

model

glass finish

profiles finish

opening  sx  dx

Vismaravetro Srl  
20843 Verano Brianza (MB) - Italy  
Via Furlanelli, 29  
phone: +39 0362 992244  
e-mail: [info@vismaravetro.it](mailto:info@vismaravetro.it)  
[www.vismaravetro.it](http://www.vismaravetro.it)

# layouts for measures

All the technical drawings in pdf format are available on the website [www.vismaravetro.it](http://www.vismaravetro.it)

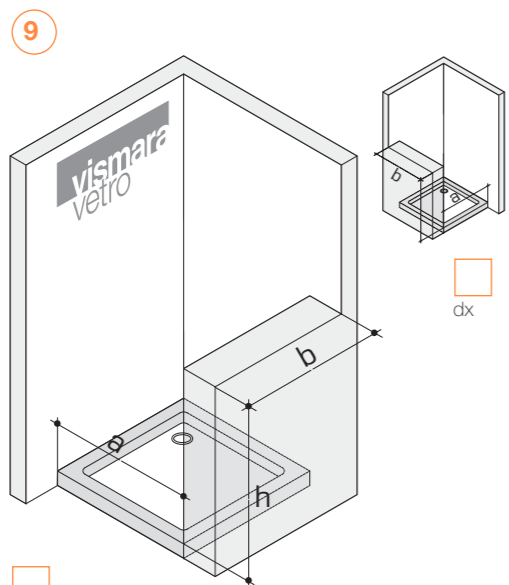

a = mm. \_\_\_\_\_  
b = mm. \_\_\_\_\_  
h = mm. \_\_\_\_\_

Gliss: **DN+DP - D3+DP - D4+DP**  
Linea: **LN+LP - LB+LP - L2+LP - L3+LP**  
Replay: **RN+RV - RM+RV**  
Sintesi: **SN+SP - SM+SP**  
Junior: **GN+GP - GA+GP**  
Serie 8000: **CN+CP - C3+CP - C4+CP**  
Serie 7200: on request

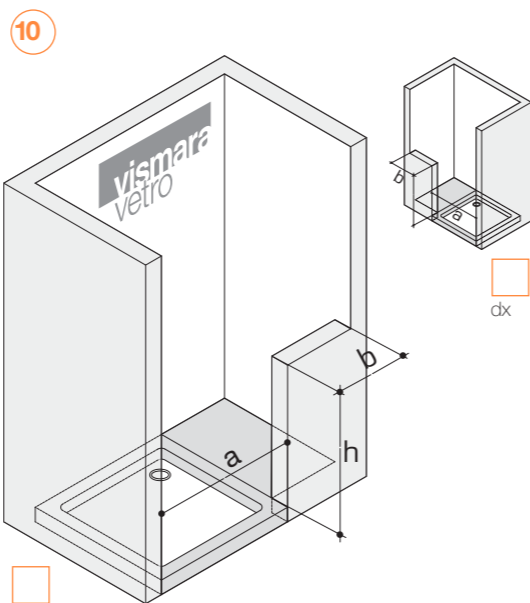

a = mm. \_\_\_\_\_  
b = mm. \_\_\_\_\_  
h = mm. \_\_\_\_\_

Linea: **L2**  
Replay: **RM**  
Sintesi: **SM**  
Serie 8000: **C3**

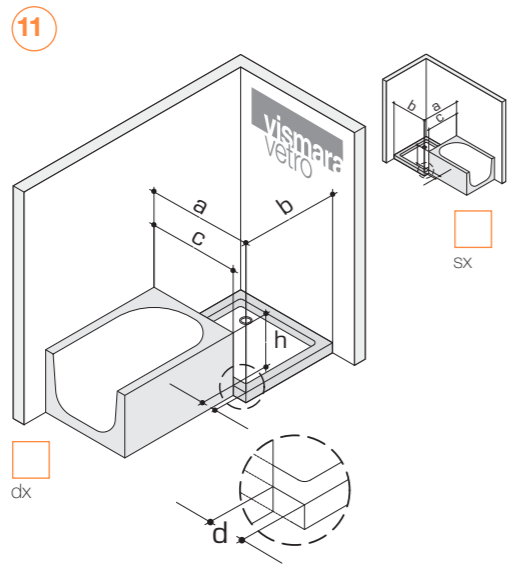

a = mm. \_\_\_\_\_  
b = mm. \_\_\_\_\_  
c = mm. \_\_\_\_\_  
d = mm. \_\_\_\_\_  
h = mm. \_\_\_\_\_

The feasibility and the choice of the programme depends on real measured size: it is recommended to request a quotation.

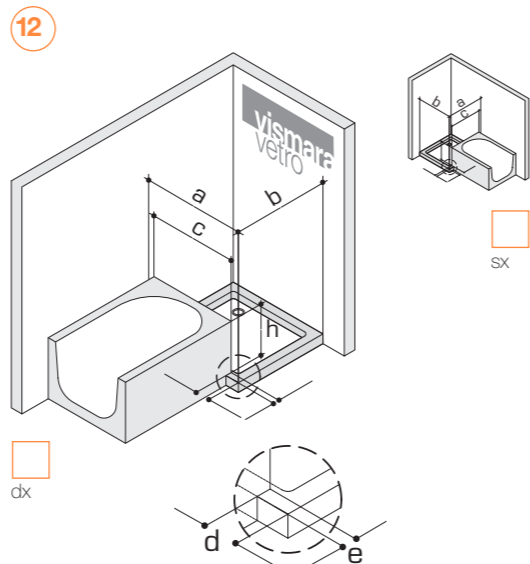

a = mm. \_\_\_\_\_  
b = mm. \_\_\_\_\_  
c = mm. \_\_\_\_\_  
d = mm. \_\_\_\_\_  
e = mm. \_\_\_\_\_  
h = mm. \_\_\_\_\_

The feasibility and the choice of the programme depends on real measured size: it is recommended to request a quotation.

Customer

Town

Phone

ref.

model

glass finish

profiles finish

opening  sx  dx

Vismaravetro Srl  
20843 Verano Brianza (MB) - Italy  
Via Furlanelli, 29  
phone: +39 0362 992244  
e-mail: [info@vismaravetro.it](mailto:info@vismaravetro.it)  
[www.vismaravetro.it](http://www.vismaravetro.it)

# layouts for measures

All the technical drawings in pdf format are available on the website [www.vismaravetro.it](http://www.vismaravetro.it)

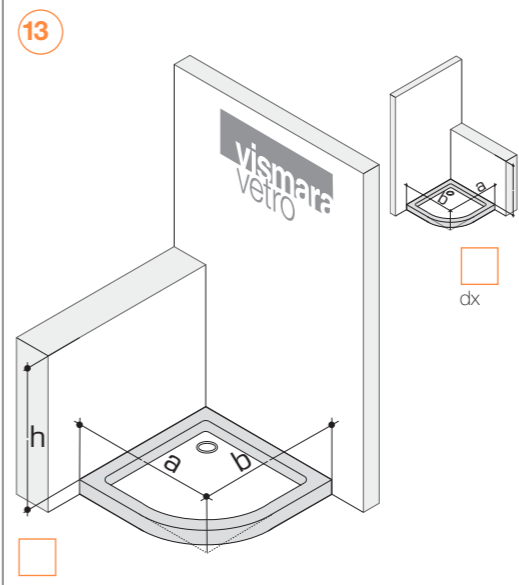

a = mm. \_\_\_\_\_  
b = mm. \_\_\_\_\_  
h = mm. \_\_\_\_\_

Linea: **LTX+LP**  
Sintesi: **ST+SP - SH+SP - SX+SP - SD+SP**  
Serie 7200: on request

Customer

Town

Phone

ref.

model

glass finish

profiles finish

opening  sx  dx

Vismaravetro Srl  
20843 Verano Brianza (MB) - Italy  
Via Furlanelli, 29  
phone: +39 0362 992244  
e-mail: [info@vismaravetro.it](mailto:info@vismaravetro.it)  
[www.vismaravetro.it](http://www.vismaravetro.it)

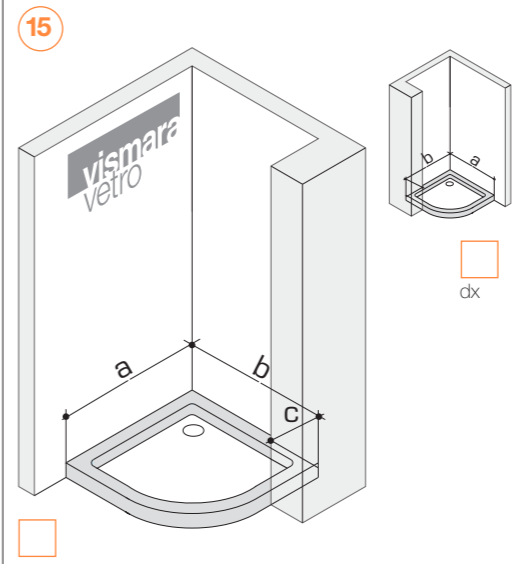

a = mm. \_\_\_\_\_  
b = mm. \_\_\_\_\_  
c = mm. \_\_\_\_\_

Sintesi: **ST - SH - SX - SD**

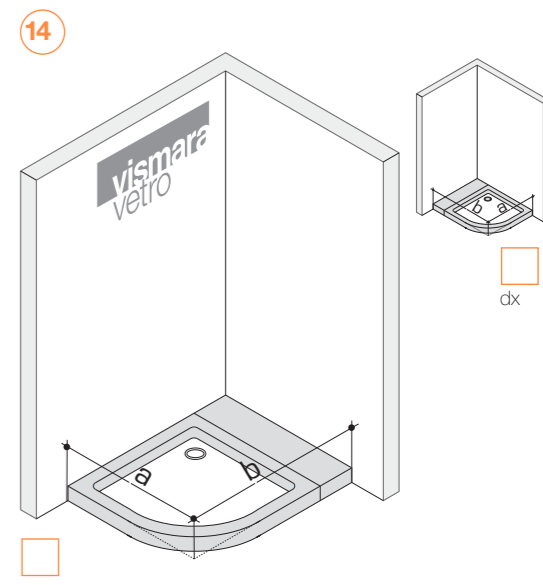

a = mm. \_\_\_\_\_  
b = mm. \_\_\_\_\_

Linea: **LTX**  
Sintesi: **ST - SH - SX - SD**  
Serie 7200: **ZT (r. 55cm) - ZD (r. 38cm)**

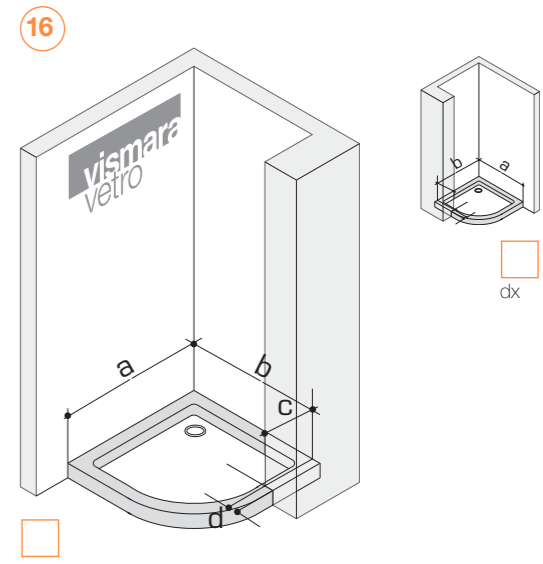

a = mm. \_\_\_\_\_  
b = mm. \_\_\_\_\_  
c = mm. \_\_\_\_\_  
d = mm. \_\_\_\_\_

Sintesi: **ST - SH - SX - SD**



**REQUEST FOR TECHNICAL ASSISTANCE**

Please fill the data in the form at the link below:

**[www.vismaravetro.it/en/assistance](http://www.vismaravetro.it/en/assistance)**

or fill in the following form and send it to us at **assistenza@vismaravetro.it** together with any attachments that may help us to correctly identify the problem.

Customer .....

Adress.....

requests technical assistance for the following product :

PROGRAMME	MODEL	MEASURES	GLASS	PROFILES	TPA

Barcode number.....  
It can be found on the product's check list or on the warranty certificate enclosed with the product.

Delivery note or invoice .....

These details are necessary for the correct identification of the product delivered and any spare parts.

The products were installed by ..... on (date) .....

at the final customer.....

street.....

town.....

Phone..... email .....

**Problem description**

If the product is not covered by the warranty, the claimant undertakes to pay the cost of the repair. The terms and conditions of the warranty are shown on the certificate enclosed with the product and can be downloaded from our website [vismaravetro.it/warranty](http://vismaravetro.it/warranty) . To benefit from the extended 36-month warranty on glasses, the product must be registered in the appropriate section of the Vismaravetro website within 24 months from purchase date.

for approval,  
date.....

(stamp and signature)

general terms of sale

- 1 - Prices are ex works Vismaravetro, VAT not included.**  
Prices can be modified without prior notice.
- 2 - Standard packing in carton box is free.**
- 3 - All special packings will be charged at cost.**
- 4 - All orders are subject to approval by Vismaravetro.**
- 5 - Minimum amount per order Euro 2.000,00 = net**  
For lower amount an extra charge of Euro 50,00 will be debited.
- 6 - Orders for special executions have to be quoted,** with all necessary details otherwise no complaints will be taken into consideration in case of non conformity.
- 7 - Order cancellations, modifications or any other remarks between original order and Vismaravetro's written confirmation have to be transmitted within 48 hours from receipt date of sales confirmation.**  
Otherwise orders will be completed and neither the goods supply nor the payment can be refused.
- 8 - Orders can be also partially fulfilled.**
- 9 - Production and delivery date are not binding and in no case can the customer totally or partially refuse the consignment or ask for reimbursement for delays.**
- 10 - The goods are transported at the consignee's risk even when the transport costs are paid by Vismaravetro.**
- 11 - The consignee shall examine the goods upon arrival and make a written and formal notification on the consignment note for any damage before accepting the consignment.**  
If damages are ascertained, the consignee shall send a written advise to Vismaravetro together with copy of consignment note with notification to the forwarder, within 5 days from receipt of the goods, otherwise no reimbursement will be recognized.
- 12 - No complaints will be accepted after 5 days from receiving the goods.**
- 13 - Vismaravetro is not responsible for incorrect functioning of products or water leaks caused by:**
  - inadequate walls or wrongly installed trays
  - incorrect installation or installations non in accordance with Vismaravetro fitting instructions
  - tampered components
- 14 - No goods can be returned without written authorisation by Vismaravetro.**  
Authorized returns shall be forwarded, carriage paid, to our works.  
Consignment note shall indicate original shipping invoice number and date.  
In case of non-adherence to this procedure goods will be refused.  
Moreover the relevant amount to be credited will be deducted by 40% for general expenses in addition to eventual costs for reconditioning the goods.
- 15 - The bank rate of interest shall be debited for any late payment.**
- 16 - Delayed payments entitles Vismaravetro to cancel all outstanding orders.**
- 17 - Sales take place with retention of title in accordance of art. n.1523 and subsequent of Italian Civil Code.**  
The products remain the property of Vismaravetro company until total payment of the amount.
- 18 - Vismaravetro reserves the right to modify its products at any time without notice.**
- 19 - In case of litigations Monza is designed as the only Forum.**
- 20 - The above terms are considered entirely accepted when placing any orders.**

Vismaravetro srl  
via Furlanelli 29  
20843 Verano Brianza (MB) Italy  
IT01768720136

## Vismaravetro srl

20843 Verano B. (MB) Italy  
via Furlanelli, 29  
phone +39 0362 992244  
e-mail: [info@vismaravetro.it](mailto:info@vismaravetro.it)  
[www.vismaravetro.it](http://www.vismaravetro.it)

